

# VisualAnalysis 19.0

## User's Guide

### A New Commercial Version is Available.

IES has upgraded VisualAnalysis 19.0. The latest release can be found on our website at: [www.iesweb.com/downloads](http://www.iesweb.com/downloads)

Version 19.0 is the latest educational release.



---

Updated: 12/21/2022

Copyright © 1994-2022 IES, Inc. All rights reserved.

## Table of Contents

1.	<a href="#">Essentials</a>	6
1.1.	<a href="#">Welcome to VisualAnalysis 19</a>	6-7
1.2.	<a href="#">Getting Started</a>	7-8
1.3.	<a href="#">Program Layout</a>	8-11
1.4.	<a href="#">Preferences</a>	11-13
1.5.	<a href="#">Building Code Support</a>	13-14
1.6.	<a href="#">Graphic Views</a>	14-15
1.7.	<a href="#">Graphic Filters</a>	15-16
1.8.	<a href="#">Project Files</a>	16-17
1.9.	<a href="#">Custom Data Files</a>	17-18
1.10.	<a href="#">Shapes</a>	18-19
1.11.	<a href="#">Materials</a>	19-20
1.12.	<a href="#">Printing</a>	20-21
2.	<a href="#">Model</a>	22
2.1.	<a href="#">How To</a>	22
2.1.1.	<a href="#">Selection and Editing</a>	22-24
2.1.2.	<a href="#">Working in Model View</a>	24-27
2.1.3.	<a href="#">Editing Models</a>	27-28
2.1.4.	<a href="#">Creating Models</a>	29-30
2.2.	<a href="#">Model Topics</a>	30
2.3.	<a href="#">Project Settings</a>	30-33
2.4.	<a href="#">Nodes and Supports</a>	33-35
2.5.	<a href="#">Member Elements</a>	35-46
2.6.	<a href="#">Plate Elements</a>	46-52
2.7.	<a href="#">Areas</a>	52-55
2.8.	<a href="#">Soil-Spring Generator</a>	55
2.9.	<a href="#">Cable Elements</a>	55-57

2.10.	<a href="#">Semi-Rigid Connections</a>	57-58
2.11.	<a href="#">Limitations</a>	58-59
3.	<a href="#">Load</a>	60
3.1.	<a href="#">How To</a>	60
3.1.1.	<a href="#">Working With Loads</a>	60-62
3.1.2.	<a href="#">Example: Unbalanced Snow Loads</a>	62-66
3.2.	<a href="#">Loading Topics</a>	66-67
3.3.	<a href="#">Nodal Loads</a>	67
3.4.	<a href="#">Member Loads</a>	67-70
3.5.	<a href="#">Plate Loads</a>	70-71
3.6.	<a href="#">Area Loads</a>	71-72
3.7.	<a href="#">Load Cases and Combinations</a>	72-78
3.8.	<a href="#">Dynamic Loads</a>	78-79
3.9.	<a href="#">Moving Loads</a>	79-81
3.10.	<a href="#">ASCE Load Helper</a>	81-82
4.	<a href="#">Analyze</a>	83
4.1.	<a href="#">How To</a>	83
4.1.1.	<a href="#">Working in Result View</a>	83-84
4.2.	<a href="#">Analysis Topics</a>	84-85
4.3.	<a href="#">Understanding Analysis</a>	85-87
4.4.	<a href="#">Nonlinear Theory</a>	87-88
4.5.	<a href="#">Analysis Performance</a>	88-89
4.6.	<a href="#">Static Analysis</a>	89-92
4.7.	<a href="#">Dynamic Analysis</a>	92-94
4.8.	<a href="#">Time History Analysis</a>	94-97
4.9.	<a href="#">Result Superposition</a>	97-98
4.10.	<a href="#">Envelope Results</a>	98-99
5.	<a href="#">Design</a>	100

# VisualAnalysis 19 User's Guide

5.1.	<a href="#">How To</a>	100
5.1.1.	<a href="#">The Design Process</a>	100-101
5.1.2.	<a href="#">Loading For Design</a>	101-103
5.1.3.	<a href="#">Modeling For Design</a>	103-104
5.1.4.	<a href="#">Analyze For Design</a>	104-105
5.1.5.	<a href="#">Working in Design View</a>	105-106
5.2.	<a href="#">Concepts</a>	106
5.2.1.	<a href="#">Groups</a>	106-107
5.2.2.	<a href="#">Unity Checks</a>	107-109
5.2.3.	<a href="#">Bracing</a>	109-110
5.2.4.	<a href="#">Deflections</a>	110-111
5.2.5.	<a href="#">Design Parameters</a>	111-112
5.3.	<a href="#">Design Topics</a>	112-113
5.4.	<a href="#">Wood Design</a>	113-120
5.5.	<a href="#">Steel Design</a>	120-128
5.6.	<a href="#">Generic Stress and Deflection Checks</a>	128-131
5.7.	<a href="#">Aluminum Design</a>	131-136
5.8.	<a href="#">Cold Formed Steel Design</a>	136-141
5.9.	<a href="#">Composite Steel Beam Design</a>	141-152
5.10.	<a href="#">Concrete Design</a>	152-153
5.11.	<a href="#">Concrete Beam Design</a>	153-161
5.12.	<a href="#">Concrete Column Design</a>	161-167
5.13.	<a href="#">Concrete Wall/Slab Design</a>	167-172
6.	<a href="#">Report</a>	173
6.1.	<a href="#">How To</a>	173
6.1.1.	<a href="#">Working in Report View</a>	173-175
6.2.	<a href="#">Reports</a>	175-176
6.3.	<a href="#">Tables</a>	176-177

6.4.	<a href="#">Saved Reports</a>	177-178
6.5.	<a href="#">Report Notation</a>	178-184
6.6.	<a href="#">Member Graphs</a>	184
7.	<a href="#">Succeed</a>	185
7.1.	<a href="#">History</a>	185
7.1.1.	<a href="#">Version History</a>	185
7.1.2.	<a href="#">Prior Version 18.0</a>	185-188
7.1.3.	<a href="#">Prior Version 17.0</a>	188-193
7.1.4.	<a href="#">Prior Version 12.0</a>	193-194
7.1.5.	<a href="#">Prior Version 11.0</a>	194-195
7.1.6.	<a href="#">Prior Version 10.0</a>	195-197
7.2.	<a href="#">Upgrade Guide</a>	197-199
7.3.	<a href="#">Support Resources</a>	199-200
7.4.	<a href="#">Improving Performance</a>	200-201
7.5.	<a href="#">My Model is Unstable</a>	201-202
7.6.	<a href="#">Validate Your Results</a>	202-203
7.7.	<a href="#">Educational Version</a>	203-204
8.	<a href="#">Integration</a>	205
8.1.	<a href="#">How To</a>	205
8.1.1.	<a href="#">Example: Create CFS Library and Import into VisualAnalysis</a>	205-208
8.2.	<a href="#">IES ShapeBuilder</a>	208
8.3.	<a href="#">IES VisualFoundation</a>	208-210
8.4.	<a href="#">IES VA-Revit Link</a>	210
8.5.	<a href="#">IES VAConnect</a>	210-211
8.6.	<a href="#">IES QuickFooting</a>	211-212
8.7.	<a href="#">CFS</a>	212
8.8.	<a href="#">Windows Clipboard</a>	212-213
8.9.	<a href="#">DXF/DWG Files</a>	213-214

8.10. <a href="#">STAAD Files</a>	214-216
8.11. <a href="#">Command Line</a>	216

## 1 Essentials

### 1.1 Welcome to VisualAnalysis 19

VisualAnalysis is a general-purpose analysis and design tool for structural engineers and related professions. The finite element method is the basis for the analysis and structural design can be performed for concrete, steel, wood, aluminum, and cold-formed steel members according to the appropriate American or Canadian design specifications. Over the past 25 years, VisualAnalysis has been used by thousands of engineers to solve a wide variety of structural problems.

#### Getting Started

- [Training Videos](#)
- Use **File | Open** Example to see sample projects.
- [Program Layout](#)
- [Upgrade Guide \(What's New?\)](#)
- [FAQ Answers](#) at iesweb.com for business, licensing, installation issues.
- Downloadable [PDF Help](#) file.

#### Key Steps

- [Model](#): Projects, model types, element types, sign conventions
- [Load](#): Loading, load cases, load combinations
- [Analyze](#): Setup, theory, process, results
- [Design](#): Design process, bracing, terminology, materials supported
- [Report](#): Creating and managing reports, both text and graphics

#### Help Notation

- Menu items are appear like this: **File | New**.
- Keystrokes or mouse commands appear like this: **Shift+Click**.

#### Purchase Levels

VisualAnalysis is purchased in one of four levels. Some topics are flagged with a required level. The level-features are summarized below, but described completely at: [www.iesweb.com/va](http://www.iesweb.com/va).

- **Simple Analysis**: 3D models, static and dynamic analysis, no design checks, code independent
- **2D Design**: 2D member models, static analysis, steel and wood design checks
- **Full Design**: 2D Design features, plus 3D, plates, dynamic analysis and design checks in all materials
- **Advanced**: All available features

#### Disclaimer

VisualAnalysis is a proprietary computer program of Integrated Engineering Software (IES, Inc.) of Bozeman, MT. This product is intended for use by licensed, practicing engineers who are educated in structural engineering, students in this field, and related professionals (e.g. Architects, Building Inspectors, Mechanical Engineers, etc.). Although every effort has been made to ensure the accuracy of this program and its documentation, IES, Inc. does not accept responsibility for any mistake, error, or misrepresentation in, or as a result of, the usage of this program and its documentation. (Though we will make every effort to ensure that problems that we can correct are dealt with promptly.) The results obtained from the use

# VisualAnalysis 19 User's Guide

of this program should not be substituted for sound engineering judgment.

## License and Copy Restrictions

By installing VisualAnalysis on your computer, you become a registered user of the software. The VisualAnalysis program is the copyrighted property of IES, Inc. and is provided for the exclusive use of each licensee. You may copy the program for backup purposes and you may install it on any computer allowed in the license agreement. Distributing the program to coworkers, friends, or duplicating it for other distribution violates the copyright laws of the United States. Future enhancements and technical support depend on your cooperation in this regard. Additional licenses and/or copies of VisualAnalysis may be purchased directly from IES, Inc.

## IES, Inc.

Integrated Engineering Software, Inc.  
519 E. Babcock St.  
Bozeman, MT 59718

**Sales or Licensing:** 406-586-8988, [sales@iesweb.com](mailto:sales@iesweb.com)

**Technical Support:** [support@iesweb.com](mailto:support@iesweb.com)

## 1.2 Getting Started

### VisualAnalysis Introduction

VisualAnalysis uses the following workflow. More information on how to get started can be found in the [Training Videos](#).

1. [Model](#)
  - a. Sketch members in the Model View by clicking and dragging the mouse on the Grid. Nodes are automatically created at the member's ends.
  - b. Adjust the parameters of the grid or add new grids of various types in the **Project Manager | Grid** tab.
  - c. Select items graphically with a mouse-click to edit them in the **Project Manager | Modify** tab.
  - d. Click on the white-space in the Model View to Select "nothing" and modify the Project Settings.
  - e. Use the right-click context-menu for quick relevant commands pertaining to the view (Model View, Result View, Design View) and the items that are currently selected.
  - f. Use the **Project Manager | Filter** tab in each view to show or hide information graphically.
  - g. Select nodes in the Model View to define the support conditions.
2. [Load](#)
  - a. Choose a Service Load Case, such as D (Dead Loads), L (Live Loads), etc.
  - b. Select one or more nodes or members, then Apply Nodal Load or Apply Member Load using the buttons in the Loading Ribbon.
  - c. Use the Load Case Manager to select load cases from standard building codes or to create custom load combinations.
3. [Analyze](#)
  - a. The finite element analysis is automatically performed (i.e. there is no button to click).
  - b. The analysis results (displacements, forces, moments, and stresses) are displayed in the Results View.
  - c. Adjust the setting in the **Project Manger | Results Filter** tab to modify what is shown graphically in the Results View.
4. [Design](#)
  - a. Manually add the members to Design Groups or allow VisualAnalysis to Auto-Group Members using the



feature in the Modify tab.

- The design is performed automatically and the maximum unity value (demand to capacity ratio) is graphically displayed for each member in the Design View.
- Manually adjust the parameters of the members or use the Design The Group to search for the optimal member section.

## 5. Report

- Create reports in the Report View by double-clicking or dragging and dropping from the available tables in the **Project Manager | Add Table** tab.
- Adjust the Report Setting and Model Filters in the Modify tab or rearrange or delete the tables in the report.
- Click on tables in the report to select them and adjust the parameters in the **Selected Table** tab.

## 1.3 Program Layout

The best way to learn VisualAnalysis is to use and explore the program to get to know what is available under each button or menu. Several [Tutorial Videos](#) are also available which explain many features of the software.

### Screen Layout

The image below introduces the program terminology used in this help file and the training videos. Panels may be resized by dragging their dividers or repositioned by dragging their title bars or right-clicking on the title. Use the "pushpin" icon to collapse panels temporarily to gain more space for working. Hold the mouse pointer over the screen image below for information about each area of the program.

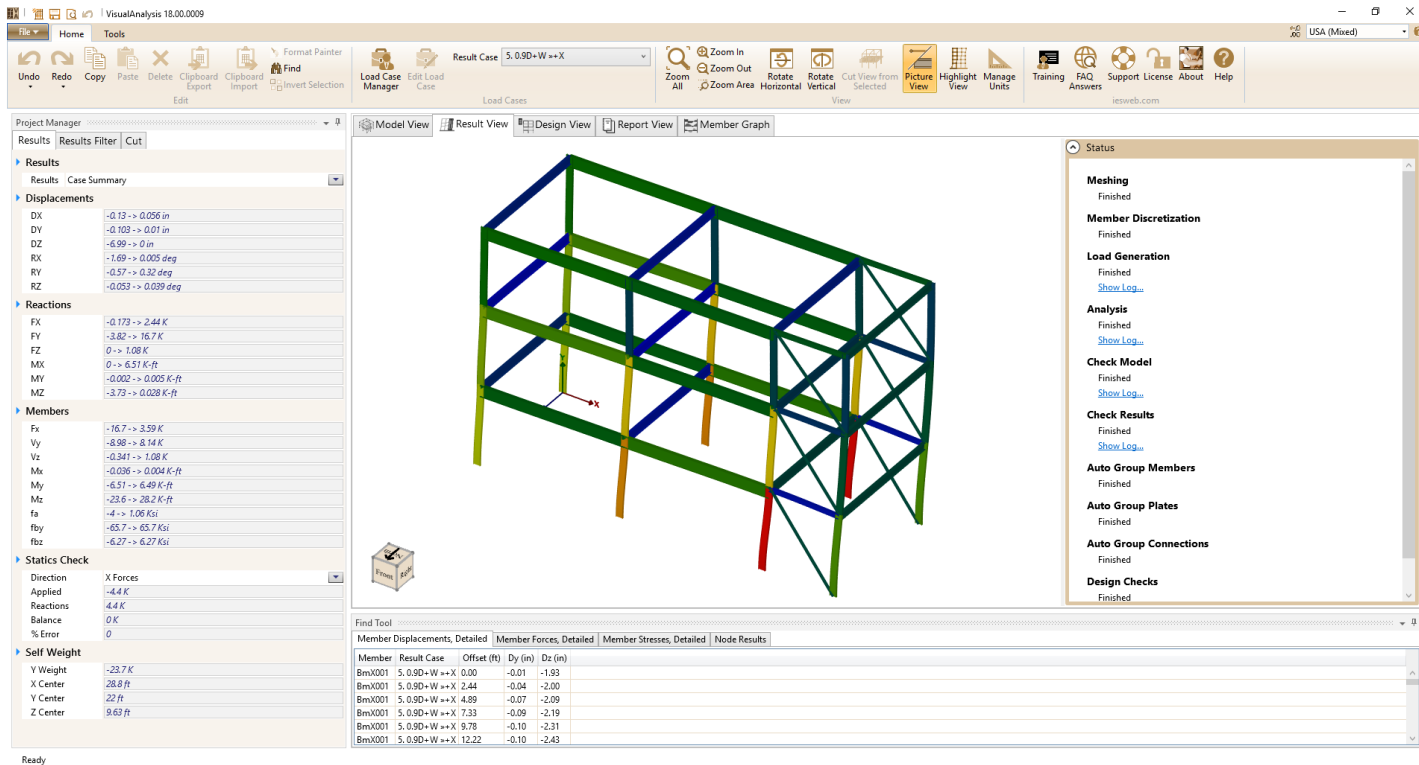

### The Main Menu / Toolbar

# VisualAnalysis 19 User's Guide

The main menu, Toolbar, or Ribbon, contains various commands to direct VisualAnalysis. Each is organized within a group to help locate them quickly. Some ribbon tabs only appear when working within a certain window. Each command has a description which appears when the mouse pointer is hovered over it. Many have hot-key shortcuts.

## The Project Manager

The Project Manager provides immediate access to frequent operations in VisualAnalysis. This tool is docked on the left side of the window by default and displays various tabs depending on the active window. This window can be docked on the left or made to float independently if more space is needed to work. Alternatively, drag the side border to make it wider or narrower.

- The **Modify** tabs are used to change the project settings or the properties of selected objects in the Model View or Design View. In the Report View, this tab is used to adjust the Report Settings and Included Tables.
- The **Filter** tab is used to control what is shown or hidden in the active view.
- The **Grid** tab is used to control the Sketch Grid to aid in drawing models in the Model View.
- The **Result** tab replaces the Modify tab when the Result View is active. This tab provides key result information for the active load case.
- The **Cut** tab is used to create geometric slices or boxes to work with a portion of complex 3D models.
- The **Create** tab is used to quickly generate model objects and common structures.
- The **Add Tables** tab is used to add available tables to the report.
- The **Selected Table** tab is used to modify the parameters of the table selected in the report and to select which table columns to display.
- The **Reports** tab is used to save active reports or used existing report styles.

## Graphic Views

These views provide a way to view the model, analysis results, design results, and reports. Each tab displays different options and will provide different information in the Project Manager and Find Tool. Some Graphic tabs will only appear based on objects in your model, such as the Member Graph.

## Status

This panel provides a quick update on what is done, what is in-progress, and whether things are working or failing in the model or checks. Click on any item that is underlined for more information. The Status window is only available in the Results View and the Design View.

## Status Bar

Shows background meshing/analysis progress. Background processing is done on a separate thread of the processor, so you can continue working while they run. The only time you need to wait for the program is when the mouse cursor changes into an hour-glass or if you wish to view the analysis or design checks that are currently in-progress. Detailed progress bars are available for background activity by double-clicking on the status-bar at the bottom of the screen.

## Find Tool

The Find Tool provides an efficient way to view, select, and edit nodes, members, loads, design groups and many other aspects of your model. This tool is docked on the bottom of the window by default. Use **F7** or the push-pin icon to auto-hide this panel. When docked, drag the side border to make the panel larger or smaller. The Find tool allows you to find, select, edit, and delete objects even if they are not visible in the active window. **Double-click** on an element (member, plate, spring) and the graphics window will zoom-in to show that element, if it is visible. Lists shown in the Find tool can be sorted by clicking on a column header (**click** again to reverse the order). Select items just like any list in Windows using the **Shift** and **Ctrl** keys to select a range or to toggle individual items.

## Unit Styles, Precision

Above the toolbar on the far right is the Units drop-down for selecting the way physical quantities are displayed. Change the number of decimal places or significant digits using the icon to the left of the unit selector. Go to [Home | Manage Units](#) to create custom unit styles or edit existing unit styles.

## Data Entry: Physical Quantities

Enter values in any unit style. Enter any number or [math expressions](#) followed by a known abbreviation. Length units may be entered in "ft-in-16ths" notation as well. Entered values are converted and then redisplayed in the current 'display' units.

## Window Locations

VisualAnalysis will automatically remember the window and panel locations. Panels like the Project Manager or Find Tool can be collapsed with auto-hide, or floated in a separate window. You can reset the window layouts using the [Tools | Custom Data](#) command to locate the *VA.DockingLayout.xml* file and delete it.

## Mouse and Keyboard Commands

### Selection:

- **Click** to select (mouse hover indicates what object will be selected)
- **Click** in the 'whitespace' of a view to unselect everything and access Project Settings.
- **Ctrl+Click** to toggle object selection without affecting other objects
- **Shift+Click** to select all objects of a given type.
- **Shift+Drag** draw a selection box (left-to right selects fully enclosed objects, right-to-left selects any partially enclosed objects)
- **Shift+Ctrl+Click** to select items of one type with the same Name Prefix as the item clicked on.

### Zoom:

- **Scroll Mouse Wheel** with the pointer over the point to zoom in or out from.
- **Double Click Mouse Wheel** to Zoom All.
- **Ctrl+** (plus) and **Ctrl-** (minus) keys.
- **Ctrl+Home** for zoom all/extents
- **Ctrl+End** to enable the [Home | Zoom Area](#) command then **Drag** to create the Area.

### Pan:

- **Drag Mouse Wheel** to pan.
- **Shift+Arrow** keys will also pan.

### Rotate:

- **Ctrl+Drag Mouse Wheel** to rotate the view.
- **Click** on a face, edge or corner of the Cube in the lower-left corner of the graphics to rotate the view.
- **Ctrl+Arrow** keys will also rotate.
- **Click** the [Home | Rotate Horizontal](#) button or the [Home | Rotate Vertical](#) button (**Shift+Click** on the buttons to rotate in the opposite direction)

# VisualAnalysis 19 User's Guide

## Context Menu:

- **Right-Click** the mouse for a short menu of relevant commands based on the view and what is selected.
- **Shift+F10** also display the context menu.

## Hot Keys:

- **Alt** will expose the hot-keys in the main menu
- **F** Hold to temporarily show 'Fly-by' information under mouse.
- **F1** Help.
- **F7** Show or hide the Find Tool.
- **F9** Toggle Picture View
- **Esc** Cancel the Graphic drawing and enter the Draw Nothing mode.
- **Delete** the Graphic selection.
- **Ctrl+C** Copy graphic image to clipboard.
- **Ctrl+V** Generate copies, or paste graphics in Report View.

## Miscellaneous:

- **Drag** in the Model View to sketch members, plates, cables, or areas between grid points or existing nodes.
- **Double Clicking** in a Result View or Design View this will generate a report for the object. Double-clicking on an element or node in the Find Tool will Zoom to that item.
- **Ctrl+Alt+Drag** on a node to move the node. Note: Two nodes cannot be merged in this fashion (move the nodes close and use the **Tools | Consolidate Nodes** command to merge).

## Middle-Mouse "Button" in Windows

Depending on your system, you may need to go into Control Panel, Hardware, Mouse, and set the wheel button to behave like a "middle button click". Some mouse utility programs may override that setting or it may not be set up on some versions of Windows.

## 1.4 Preferences

VisualAnalysis preferences are default settings that primarily affect the behavior of new projects. These are not project-specific settings, which are found in the [Project Manager](#). The preference settings can be adjusted through **Tools | Preferences**. Some settings do not take effect until a new project is created or until the program is restarted. Use the Restore All Defaults button to restore the VisualAnalysis preference settings to their original state. While most of the preference settings are self-explanatory, a few are documented below. Preference settings are saved on your machine in the IES folder: `C:\Users\<your.login>\AppData\Local\IES\Customer`.

### Project

The project preferences affect new projects, and do not affect the current project. For current projects, use the settings in [Project Manager](#).

- **Vertical Axis** - Specify which axis is the vertical axis. Determines the direction of the self-weight and affects load combinations. VisualAnalysis prefers 'Y' but some CAD systems prefer 'Z'.
- **North Axis** - This setting is displayed on "the cube" in the graphics, but otherwise has little impact in the software.
- **Static Analysis** - Choose what type of analysis (First Order, P-Delta, or AISC Direct) is the default setting in the

Project Manager.

- **Mode Shapes** - Set the maximum number of automatically calculated mode shapes.
- **Crash Protection** - Set how often VA saves crash-protection file. This goes in the Temp folder and is independent of History Files.
- **History Files** - Set how many once-per-day backup files VisualAnalysis should keep. Files are located in [Tools | Custom Data](#) in the History Files folder.

## Data

Set the default name prefixes for nodes, members, plates, springs, areas and area sides. These settings apply to the first objects created in a new project or immediately after restarting VisualAnalysis.

## Fonts

Change the character size and styles used to display text in graphic views and reports.

## Reports

- **Customer Logo** - Specify the location of a logo to use for the reports. If left blank, AppData\Local\IES\Customer\ReportLogo.jpg will be tried.
- **Logo Alignment** - Select the alignment of the logo in the header.
- **Member Results Offsets** - Input the number of interpolated result locations along the member in some results tables (2-201).
- **Conciseness** - Specify the level of detail in design group or mesh result reports.
- **Include Parameters** - Include input design settings in design group or mesh result reports.
- **Maximum Page Count** - Input the number of pages allowed in a report before a warning and truncation occurs.
- **Show Sort Arrow** - Choose if an arrow should be shown in the header indicating the sort column and sort direction.

## Graphics

- **Graphic Sizes** - Change how large objects are drawn in graphic views.
- **Rotate, Pan, & Zoom** - Control how much or how fast the view changes with mouse-wheel or arrow keys.
- Change Selection Size: When selected, objects may increase in thickness when selected, not just in color.
- **Draw Loads Away** - Determines the direction of load arrows relative to the loaded object.
- **Draw Reactions Away** - Determines the direction of reaction arrows relative to the supported node.
- **Scale Arrows** - Allows the arrows to be proportional to the magnitude of the load. THIS option can lead to small load arrows which can make it difficult to determine the arrow direction.
- **Draw Member Wireframe** - Select to have a wireframe drawn on the members in the picture view. This may improve the display of the boundaries of the member shape.
- **Graphic Card Settings**: Adjust the graphic card settings used in VisualAnalysis. Use this option with caution. It is not advised to change the setting unless performance issues related to graphics are being experienced.
- **Picture View Support Size** - Change the size of fixed and pinned nodal supports in the picture view.
- **Print Resolution** - Set the DPI (dots per inch) precision to be used when displaying graphics views on the printer or when placing graphics information on the clipboard.
- **Background Image** - Select an image that will be stretched to fit on the background of the graphic views.

## Default Colors

# VisualAnalysis 19 User's Guide

Change the colors of objects in Graphic Views and Reports. Every visible object type shown in graphic views have a default color (e.g. members are blue by default). Choose from standard color schemes or create a custom color scheme. Note: The Color Mode in the Model Filter must be set to Default Colors to use these color schemes.

## Named Colors

Change the colors of objects in Graphic Views and Reports that have specific prefixes. Note: The Color Mode in the Model Filter must be set to Named Colors to use these color schemes.

## Filters

Change the defaults for the filter settings in VisualAnalysis.

## Design

- **Unity Success Limit** - To allow some slight 'overstress', the Unity Success Limit can be increase to a value greater than 1.0. For example setting the Unity Success Limit to 1.01, allows a 1% overstress in the design check before the program flags a failure. This setting will affect the current project, the next time unity checks are made.
- **Design Check Level** - Set the default for the level of detail reported from the design checks.
- **Frames Sidesway?** - Changes the defaults for column design parameters.

## Deflection Limits

VisualAnalysis can check member deflections with a span ratio or an absolute limit. Specify the defaults here for any one of four 'deflection categories' as defined in IBC.

## Steel & Composite Beam

Composite beam design involves many input parameters. The defaults can be defined for many of the parameters. These settings will not affect any existing design groups in a project, but will be used when a new design group is created in any project. More information can be found in the [Composite Design](#) topic.

## Concrete

Composite beam design involves many input parameters. The defaults can be defined for many of the parameters. These settings will not affect any existing design groups in a project, but will be used when a new design group is created in any project. More information can be found in the [Concrete Design](#) topic.

## Aluminum

Buildings are checked differently than bridges, select the default construction type. The default for whether or not to use heat affected material properties can also be set.

## 1.5 Building Code Support

VisualAnalysis loosely supports the IBC, NBC, and ASCE 7 building codes. The IBC and NBC reference several design specifications and VisualAnalysis [Designs](#) according to the referenced specifications. Load combinations can be automatically generated in VisualAnalysis based on the various building codes.

## Loads

While VisualAnalysis does not create loads automatically, there are some features for calculating ASCE 7 dead loads, live loads, and wind load, based on the user input. The user inevitably decides how and where loads are applied.

## Load Combinations

VisualAnalysis has several [Building Code Combinations](#) that are included in the program. When selected these combinations are automatically maintained as loads are added or removed to service load cases. The building code combinations can be customized by hiding existing code combinations or adding custom combinations. There are a number of [Project Settings](#) that will affect load combinations and some design checks that are specific to the building code, but they are only used for the load combinations. Seismic provisions in the project manager are only used for generating load combinations.

## Material Design

VisualAnalysis supports AISC & CSA [Steel Design](#), ACI & CSA [Concrete Design](#), NDS [Wood Design](#), ADM [Aluminum Design](#) and AISI [Cold-Formed Steel Design](#). The specific design specifications are listed in those sections.

## Deflection Checks

VisualAnalysis uses [Deflection-Checks](#) load combinations defined by the IBC and the user specifies actual deflection-limits. Custom deflection load combinations can also be created.

## 1.6 Graphic Views

VisualAnalysis can show many different views of the model, loads, analysis results, and design results. [Graphic Filters](#) are used to control what is shown or hidden in the model. The following views are available in VisualAnalysis (some tabs will only appear when applicable).

- **Model View** - Create/edit models, check element orientations, sizes, materials, and apply loads.
- **Result View** - Inspect analysis results and generate result reports.
- **Design View** - View unity checks, design members, and access design reports.
- **Report View** - Create custom reports and system reports.
- **Member Graph** - Displays detailed member deflection, moment, shear, and stress diagrams.
- **Influence Graphs** - Displays influence lines for Moving Load results.
- **Node Graphs** - Displays node results from Time History Analysis cases (select a node in the Results view).

## Cut Volumes

Use the [Project Manager | Cut](#) tab to simplify how complicated 3D models are viewed. A cut plane or cut volume acts as a geometric filter. Anything entirely within the cut definition is visible and anything outside of it is not. VisualAnalysis allows multiple cut planes or volumes to be enabled simultaneously.

- **Cut Plane** - Isolates a single floor plan or elevation in a typical rectangular frame.
- **My Cut Volumes** - User-defined "boxes" that may be oriented to match the model. Isolates more than a plane (e.g two floors and the columns between them).

## Cut View from Selected

An easy way to define a Cut Volume is to select two or three nodes or elements in the model and choose [Cute View from Selected](#) in the Context Menu (*Right Click*) or use the **Ctrl+K** hot keys. This command has the effect of automatically adjusting the Cut Volume settings to show objects in the "plane" or volume of the selected objects. The cut volume is

# VisualAnalysis 19 User's Guide

saved in the **Project Manager | Cut** tab under **My Cut Volumes**. This command is not available if the selected objects do not define a "box" (e.g. three collinear points define an infinite number of planes will not produce a Cut Volume).

## Animate a Result View

Result Views can show the deflected shape which can be animated using the **Animate Result** command when in the Context Menu (right click in the Result View). For static results, this feature will help visualize how the structure is deflecting. For dynamic results, this feature displays the real-time vibration behavior.

## Sticky Notes

Attach one or more text-boxes to the window or to a model object within the view. Right-click to get the context menu and add the note, you can edit the text of the note directly in the note.

## 1.7 Graphic Filters

Filters allow various aspects of the model, results, or design views to be shown or hidden. While there are some common filter choices, each window has a unique set of filter options. The filter settings are accessed in the **Project Manager | Filter** tab.

### Window Options

- **Title** - Displays a descriptive title in the window.
- **Axes** - Show the global coordinate axes.
- **Picture View** - Shows a more realistic 3D view with element shapes and thickness rather than stick-figure graphics.
- **Highlight Report** - Selected objects are displayed normally while the others are faded. Useful for focusing attention in a printed graphical report.
- **Fly-by Information** - Provides popup tooltip information for objects under the mouse cursor.
- **View Cube** - Toggle visibility of the rotation/orientation cube.
- **Cube Axes** - Toggle the coordinate axes on the view cube.

### Name Filters

Elements can be shown or hidden based on a Name Filter. The prefix of the name of the element is matched with the Name Filter which is case sensitive. Special characters can be used in the Name Filter (for example use a period (.) to represent any single character, or a question mark (?) to represent one optional character). Prefix with @ for full regular expression syntax.

<b>Member Filter Setting</b>	<b>Effect on Graphics</b>
B	All members whose names start with the letter B are displayed
Bm, Col	All members whose names start with Bm or Col are displayed
!C	All members are shown, unless their name begins with C



## Model Filter

In the Model View, objects can be shown or hidden based on their type (Members, Plates, Nodes, etc.). Details about each object can be toggled using the Details section for the corresponding object. For example, under Member Details the shape name, end releases, or local axes can be shown.

## Color Mode

The color of the model elements can be set based on three modes listed below. Note: The color mode may not affect all objects.

- **Default Colors** - Colors are based on the type of object and preference settings.
- **Named Colors** - Colors are defined in the parameters based object name prefixes.
- **Material Colors** - Objects are displayed based on material-colors defined in the material database.

## Result Filter

The **Project Manager | Result Filter** tab is used to display element deflections, forces, or stresses, in addition to deflected shapes and reactions. Use the Result Type object to show results for members, plates, or other objects. When the legend is shown, a box mapping colors to values with slider controls for graphic filtering appears. For member elements, you can show the graphic results using colors or diagrams. The Overlay Undisplaced filter is used to show the Model View in the Result View. There are also result filters for scaling the displaced shape.

## Design Filter

The Design Filter displays information about design groups and the unity checks. The Group Name option is used to show the design group to which each member belongs.

# 1.8 Project Files

## Open a Project File

Open existing Projects using the **File | Open** command. Recent projects are listed in the Recent VisualAnalysis Projects section of the **File** menu. Hover over the recent file to see an image of the model in the project.

## Legacy Projects

Project files created and saved in previous version of VisualAnalysis are recognized and imported automatically in newer versions of the program. Depending on the version, all of the information from older format files may not be imported, but typically the model and loads will be preserved. Some features have changed significantly and projects may get modified and in some situations warnings or errors will appear. Legacy projects are upgraded to a new format when saved and cannot be read in previous versions of the product. Legacy projects can be can 'recovered' using the History Projects folder as discussed below.

## Opening Projects from Windows Explorer

**Double-clicking** on a .vap project file, or **right-clicking** on it and selecting **Open** will typically open the latest version of VisualAnalysis. If multiple versions of VisualAnalysis installed, Windows may open a different version than desired. **Right-click** and use the **Open With...** command to select the correct version and to change the default. The most recent version you "install" becomes the default for .VAP projects, but this can be customized in Windows Explorer. Attempting to open a newer .vap file with an older version, will produce an error message and the operation will fail.

## Example Projects

VisualAnalysis is shipped with a number of example projects files to demonstrate various modeling techniques ranging from basic to advanced. These can be located using the **File | Open Example Project** command.

## Save a Project File

Use **File | Save** to store the information in a VisualAnalysis Project File (.vap). Project files save the model, loads, design information, and window layouts. Analysis and Design results are not saved, but we be automatically recomputed when the project is opened.

## Splitting Projects?

VisualAnalysis does not have a specific feature for splitting projects or models. To manually split projects, open the original project file, delete the unneeded portions, and then use **File | Save As** to save the remaining portion of the project as a different file. Repeat the process with the original project file to split out a different fraction of the model.

## Merging Projects

VisualAnalysis can merge a saved project file into an open project using the **File | Import | Merge VAP Project** command. While basic model and load information will be merged, objects may get renamed and location or direction collisions of data can cause things to change or fail. The [Clipboard Exchange](#) can also be used to merge basic objects and loads. While all features in VisualAnalysis cannot be imported in this manner it may still save time over recreating items manually. Pay attention to the naming of nodes, elements, and load cases. Items in the 'clipboard' data or in the destination project may need to be renamed before completing the import.

## History Files

VisualAnalysis automatically creates files to record multiple versions of a project file as you work. These backup project files are called History Files and are saved in C:\Users\*<your.login>*\AppData\Local\IES\Customer\History Projects. Use these files to return to a previous state of the project if a file is accidentally deleted, it becomes corrupt, or if changes have been saved that you wish to undo. History Files are created every time you open a project file. The number of History Files or whether they are created at all are [Preferences](#).

## Crash Protection

VisualAnalysis automatically saves the project at an interval specified in the [Preferences](#) (2 minutes is the default setting). This file will be replaced whenever a timed backup is made. If VisualAnalysis or your system crashes, this file allows your work to be recovered up to the last save point. When VisualAnalysis is launched it checks for the existence of this files and if one exists you will be given the opportunity to open it. This file is automatically deleted when the project is successfully closed.

## 1.9 Custom Data Files

### [Open the Data Files Folder](#)

VisualAnalysis is quite customizable and most of the customizations made within the program or through other IES tools are stored in data files on a per-machine basis. Go to **Tools | Custom Data** to open your data files folder in Windows Explorer or go to C:\Users\*<your.login>*\AppData\Local\IES\Customer. This folder includes data for the following:

- [History Projects](#)

- [Load Combinations](#)
- [Materials](#)
- [Moving Truck Loads](#)
- [Plot Settings](#)
- [Response Spectrums](#)
- [Shapes](#)
- [User Loads](#)
- [Preferences](#)
- [Custom Unit Styles](#)

## XML Data Files

Many of the customizable data files are text files using XML (Extensible Markup Language). These files can be manually edited using Notepad. There are better editors available, including free tools like Notepad++, or XML Notepad. Do not edit these files in Microsoft Word or other tools that might change the format. Manually editing these files is typically not needed, but it may provide an easier way to insert some new data, remove something that is obsolete, or to merge files from two different machines.

## Customized Data

- **Sharing Data** - Customized data files can be shared with other engineers, users, or put on a different computer by copying the file(s) to the same folder on the other machine. The existing file can be replaced or merged.
- **Customized Data Backup** - If you make lots of customizations in VisualAnalysis, include the AppData\Local\IES folder in your backup plan.
- **Restore Default Data Files** - Reset the default data by deleting one or more of the files. The default file will be automatically generated when VisualAnalysis is restarted. For example, you can restore the custom unit styles by deleting the CustomUnitStyles.xml file.
- **Installation** - When VisualAnalysis is installed, the default data files are placed into an "All Users" location. Upon running VisualAnalysis, the files are copied or updated as necessary in the "Local" data file location. Therefore, each user (logon account) on a computer has their own independent customized files.
- **Uninstall** - When VisualAnalysis is uninstalled, the custom data files are not removed. Corrupt data files can cause problems, so if issue arise, manually remove data files before reinstalling the software. This is referred to as a "clean uninstall", where the following folders or registry sections are deleted. Consider deactivating the IES software licenses before performing a clean uninstall.
  - C:\ProgramData\IES
  - C:\AppData\\Local\IES
  - HKEY\_LOCAL\_MACHINE\Software\IES
  - HKEY\_CURRENT\_USER\Software\IES

## 1.10 Shapes

### IES Shape Databases

IES installs a number of proprietary shape databases such as those from AISC, NDS, or ADM that cannot be modified. Feel free to suggest libraries of shapes for IES to incorporate into VisualAnalysis to IES Technical Support.

### Custom Shape Databases

# VisualAnalysis 19 User's Guide

The custom shape database is a set of [Data Files](#) defined directly, imported, or created with [ShapeBuilder](#). Custom shapes will be available in VisualAnalysis, ShapeBuilder, and other IES products. The system is flexible and extensible, but outside of VisualAnalysis.

## Limitations

Composite shapes are not stored in the database. Not all custom shapes will be checked using the design features in VisualAnalysis, see ShapeBuilder for details. The minimum properties needed for analysis are: area, moments of inertia, section moduli, and a torsion constant. Shapes with minimal properties are deemed custom blobs.

## Format

The database consists of XML data files. XML is a text based format which is commonly used for data-exchange and can be edited easily using a simple text editor (NotePad++ is recommended since it is freeware and offers XML syntax highlighting). Microsoft Word and similar programs are not recommended as they have a tendency to corrupt the format.

## Shape Management

Look for instructions and examples, in the Customer\Shapes folder. Database files can be copied to other computers where IES products are installed. Files that are no longer needed can be deleted. Files can be edited to change data or to remove shapes or shape categories. Make sure to backup the customized files.

## Legacy .DBS Database Files

IES began creating custom shapes in the new database starting with ShapeBuilder 7.0. Shapes created using ShapeBuilder 6.0 or directly from VisualAnalysis 12.0 (or prior versions) cannot be read in VisualAnalysis 17+ (i.e. files located in the AppData\Local\IES\Data\Shapes folder). Since the old database does not contain enough information about principal section properties, there is currently no automated way to import legacy .dbs files into the new system and a new custom shape file will need to be manually created. Contact [Technical Support](#) for assistance in converting old data files.

## 1.11 Materials

### IES Material Databases

Several common material databases are included with VisualAnalysis listed under IES in the Material Database dialog box. These materials may not be modified or removed from the system. Contact IES Technical Support to suggest additional libraries of materials for IES to include in the database.

### Custom Material Databases

Custom materials can be created in VisualAnalysis which are stored in the [Custom Data Files](#). To add a custom material to the database in VisualAnalysis, click the Add Custom Material button in the Material Database dialog box. Choose the appropriate Material Type to allow design checks to be performed for that material and edit the Defining Properties as needed. Custom materials can be used by VisualAnalysis, ShapeBuilder, and other IES products (except Quick-products).

## Limitations

All IES materials are assumed to be linear, isotropic and elastic. VisualAnalysis makes common use of orthotropic materials, like wood, but does so using isotropic properties. VisualAnalysis utilizes four primary properties: modulus of elasticity, Poisson's ratio, thermal coefficient of expansion, weight density. Specific material types have additional properties that need to be defined (e.g. steel has yield stress, concrete compressive strength, etc.).

## Data Format

The database consists of XML data files. XML is a text based format which is commonly used for data-exchange and can be edited easily using a simple text editor (NotePad++ is recommended since it is freeware and offers XML syntax highlighting). Microsoft Word and similar programs are not recommended as they have a tendency to corrupt the format.

## Material Management

Look for instructions and examples, in the Customer\Materials folder. Database files can be copied to other computers where IES products are installed. Files that are no longer needed can be deleted. Files can be edited to change data or to remove shapes or shape categories. Make sure to backup the customized files.

## Legacy .DBM Database Files

VisualAnalysis 12.0 and ShapeBuilder 6.0 (and prior versions) used a different format and location (AppData\Local\IES\Data\Materials) for the material database. There is no automated way to import legacy .dbm files into the new system. New database files will need to be created based on the original data, the instructions above, and examples in the Customer\Materials folder. Materials are easy to define in the new system, so re-creating the materials should not be cumbersome.

## 1.12 Printing

### Setup for Printing

The paper settings, orientation of the page, and margins are set in **File | Page Setup**. To print, use the file **File | Print** command or click the Print button in the Report View. Note that a graphic window may consume a large amount of memory when printed. The Print Resolution can be adjusted in the Graphics section of the [Preferences](#).

### Printing Graphics

There are two ways to print graphic views of the model, results, or design. Use the **File | Print** or the **File | Print Preview** menu to create a one-page printout. Alternatively, capture the image to the Windows clipboard using **Home | Copy** and **Paste** it into a text report or any Windows application that accepts bitmap images. There is a convenient **Add View to Report** command in the Tools menu to perform the copy and paste in one step.

### Printing Member Graphs

1. **File | Print**, or **File | Print Preview**, while viewing it. This respects the **File | Page Setup** margins.
2. **Home | Copy**, then switch to Report View and **Home | Paste**. The image inserts in the report as a Member Graph Image table listed in the **Modify** tab.
3. **Home | Copy**, and then **Paste** it into any other Windows program, like Microsoft Word or Excel. The image goes in at the size of the window, but can be resized before printing.
4. Click **Customize** in the **Graph Filter** tab of the Member Graph view and use the **Export...** button in the Customization dialog box to save an image of a specific size and type.

### Print a Report

With a Report View open and active, choose **File | Print** to send the report to the printer. The **File | Print Preview** command allows the layout and number of pages to be verified before printing. Use the Save button in the Report View to save the report in a number of different file formats.

## Printing Problems

- Out-of-date printer drivers can cause problems. Download the latest driver from the printer manufacturer's website (it may need updating on the printer-server machine if printing across a network).
- Quality or "dpi" (dots per inch): generally VisualAnalysis does okay with 300 to 2400 dpi settings. Reducing the dpi setting on the printer may improve performance when printing graphics.
- Bi-Directional Printing: There is a setting available on the Ports tab of the printer setting. Try toggling this option.

## 2 Model

### 2.1 How To

#### 2.1.1 Selection and Editing

##### Selecting Items Graphically

###### Normal Selection

You can select items normally just by **clicking** on them with your mouse in a Model, Result or Design view. A single **click** selects the item and unselects everything else. The object to be selected will be indicated by a highlight color as the mouse hovers over the object. A single **click** on the background will also **unselect everything**.

To **select multiple items**, hold the **Ctrl** key while clicking. (The **Ctrl** key lets you toggle the selection state of items without unselecting anything.)

###### Select All of a Type

Use the **Shift** key to select all the visible objects of the type you click. Use **Ctrl+Shift** to select all the objects of that type that also have the same name prefix. For example, Ctrl+Shift on a member named 'BmX001' would select all the members whose names start with 'BmX'.

###### Selection Box

To select a group of items in an area, you can drag a selection box by **dragging** the mouse (primary button). Depending on the direction the box is drawn, two different selection behaviors result. Add the Ctrl key to extend the existing selection with items in your box.

- **Left to Right:** Objects **entirely inside** the selection box are selected.
- **Right to Left:** Objects entirely and **partially inside** the selection box are selected.

###### Selection Circle

You may create a selection circle using the **Shift+right mouse button drag**. Add the **Ctrl** key to extend the selection with items in your circle.

###### Keyboard Assist

When you have closely spaced objects, selection may be difficult. In these cases, holding down a keyboard "preferred key" while clicking the mouse will chose the nearest of the specified type. The available keys are:

- A** – areas, area sides, or area side result
- C** – cables or cable results
- L** – loads (member, node, area, area side, plate)
- N** – nodes or node results
- M** – members or member results
- P** – plates or plate results
- V** – vertices (for areas)

###### Tab Selection

Another way to ease selection in tight areas is to use the **Tab** key while hovering over a point which may have several

objects in the ray intersection list. As you press the tab key, objects will be selected in the order based on the distance to each object with front object first. This can be very useful when viewing in the Picture View where sizes are true object size.

## Element Search By Name

If you cannot see an object to select it, you can use the **Home | Find (Ctrl+F)** feature to locate a model element by name.

## Find Tool Selection

Clicking on an element listed in the **Find Tool** window (for a Model View) will also select the element so you can edit. **Double-clicking** in the Find Tool will zoom the graphics view to the region of that element, but keep in mind it may be filtered off.

## Inspect or Edit Objects

Use the **Modify** tab in Project Manager to view the properties of one or more selected objects. If you have multiple *types* of objects selected, you can use the type selector near the top to choose which type of object to inspect.

When editing multiple objects you may see some properties with the word "**varies**" to indicate that different objects have different values. You can replace this with a valid setting to change **all** the objects.

## Delete Objects

To delete objects, you first need to select them. This can be done graphically or with the Find tool. Use the **Home | Delete** command or its keyboard shortcut (the **Del** key by default).

The following hierarchy indicates typical cascading effects of deletion. Items nested further in are dependent upon the items above at the higher level. For example, if you delete a node any elements connected to it are also deleted. If you delete an element, any loads on that element (in all load cases) are also deleted.

- **Nodes**
  - Nodal Loads
  - **Members**
    - Member Loads
  - **Plates**
    - Plate Loads
  - Springs
- **Vertices**
  - **Areas**
    - Area Loads

There are also implications for building code load combinations if you delete loads or service cases. In the design level, design groups will get removed or modified if you remove members or plates.

## Undo & Redo

VisualAnalysis keeps an limited record of changes to your model and loads. You do not need to be afraid of making a mistake. Use the **Home | Undo** command to trace back through these operations to undo the additions, deletions, or modifications. An **Home | Redo** command is also available in case you undo too much.

Some operations are not undoable, notably editing design group parameters or deleting design groups. Please use more caution with these items, until we get these into the undo system.

Be aware that **certain operations will reset the undo**, making it unavailable. Explicitly saving your project file and other



complex or import operations will empty the undo and redo lists. Preference changes can have subtle effects on undo as well.

## Use Unit Expressions

Most VisualAnalysis edit controls accept both a value and an *optional* associated physical unit. If you leave off the unit, the unit that was displayed previously is assumed. The unit displayed is controlled by the **Home | Units** command and the type of value displayed. **You may enter data using any of the built-in units.** Here are the basic units supported in VisualAnalysis.

### Quantity Type    Units

Length	feet (ft), inches (in), millimeters (mm), centimeters (cm), meters (m), mixed feet, inches. (',")
Force	pounds (lb), kips (K), Newtons (N), kilonewtons (kN), kilogram force (kgf), and tons (t)
Temperature	degrees Fahrenheit (F), degrees Celsius (C)
Time	seconds (s), 1/seconds (Hz)

Other physical quantities are based on these units and will use some practical combination. For example a moment may be expressed in K-ft or K-in, but not in K-mm.

The display units are controlled by a **unit-style**, that you may select in the **Home** menu. You may customize the styles, if none of the built-in ones work perfectly for your situation. You may change styles at any time.

## Feet, Inches, and Fractions of an Inch

For length units you may also enter mixed feet, inches, and fractions **if you use the tick or quotation mark characters.** VisualAnalysis will recognize the following expressions:

- **13 ' 5 3/16 "**, as 13.4223 ft, or 161.1875 in
- **2' 3** as 27 in
- **3 1/2"** as 3.5 in

## Use Math Expressions

Just about every place where you enter a number in VisualAnalysis you may also enter a mathematical expression. These boxes will accept expressions including arithmetic operators. Type in expressions as you would any value. Use parentheses () to control order of evaluation. If the value is a physical quantity, place the unit last.

Math	Available
Operators	+, -, *, /, ^, (, )
Constant	PI
Exponential Functions	LOG, EXP
Trigonometric Functions	SIN, COS, TAN, ASIN, ACOS, ATAN

VisualAnalysis evaluates your expression and stores only the result. In Project Manager, expressions are evaluated immediately after you click away from the control. In a Dialog box, the expression may stay in the box until you dismiss the dialog.

## 2.1.2 Working in Model View

## Drawing Mode

Set the drawing mode between {*Draw Nothing, Draw Members, Draw Areas, Draw Plates, or Draw Cables*} to determine what kinds of elements you create by dragging the mouse. These options are available in the **Structure** tab of the main menu ribbon. You can use the Esc key to enter the Draw Nothing mode.

**Drawing Tips:** To prevent drawing elements in a Model View use **Structure | Drawing Nothing** (or the **Esc** key). If you wish to draw elements between existing nodes but not between grid points, then turn-off any grids using **Grids** tab of the **Project Manager**.

## Using Grids

Grids are helpful "layout" tools that let you predefine acceptable locations for nodes in the model. New in this version is the ability to use multiple grids and grids with irregular spacing. The **Grids** tab of **Project Manager** allows you to access the Grid Manager for creating grids or deleting them.

With grids turned on, your mouse dragging operations will "snap" to grid-points as well as to already existing nodes (in that order). You can adjust the grids at any time without affecting any existing model objects. Grids are only used to help define the locations of newly created nodes (or the elements defined between nodes and vertices). Show and hide grids using the check boxes in Project Manager. You may turn on multiple grids at one time to draw in 3D.

## Sketch a Member

In order to sketch a member in the workspace of Model View, make sure that you are in the "Draw Members" mode by selecting this item from the **Structure** tab in the ribbon menu.

Then drag your mouse and hold the button down while moving. You may drag to and from grid points or existing nodes. The mouse cursor will change to show that you are creating a member and will "rubber band" a line to show where it will go. Simply lift the mouse button to create the member.

If the grid is not turned on you will not be able to create any new nodes by sketching members. You may also sketch beyond the border of the window, watching the coordinates in the lower right corner of the Status Bar to determine when to release the button, or you may wish to "zoom out" before drawing.

Members that you sketch default to the properties of the previously drawn or edited member, so it is helpful to define properties as you create your model.

## Sketch a Plate

Make sure that you are in the "Draw Plates" mode by selecting this item from the Model menu.

To sketch a plate element in the Model View, **Click** once on a grid point or existing node to define the first corner. Then as you move the mouse you will see a "rubber band" line and a special cursor. **Click** (push and release) on each subsequent corner of the plate to define the four corners. To draw a triangular plate element, click on the starting node to finish the shape. The operation might fail if the plate edges cross, or if the plate would otherwise be ill formed.

Sketching Area objects is similar to plates, except the polygon may have more than four sides.

## Auto-Split Members

VisualAnalysis keeps your FEA model well-defined by connecting all elements at nodes as you sketch models. If you sketch a new element such that it crosses or intersects an existing element, VisualAnalysis will automatically split and connect the new element (in a cascading fashion) to produce a well-defined finite element mesh. You can prevent any auto-splitting behavior by selecting one of the crossing members and changing the Connect Crossings option. Then you will need to manually split elements or otherwise insure your model is well defined.

There is a preference setting under **Tools | Preferences**, in the **Desktop** section that allows VisualAnalysis to prompt you for the desired action {split, no split, cancel} if you prefer a more explicit method of control.

## **Modeling X-Braces**

The normal way of modeling X-bracing members is to draw two independent member elements that cross but do not connect. This is appropriate because the members typically carry only axial forces and do not need to interact for a valid analysis. You can handle any design unbraced length issues in the design group by specifying a mid-point brace, as appropriate for your situation. To use members that cross but do not split, select one of the members and uncheck its Connect Crossings option.

Caution: If you decide to connect your X-braces (so you have four member elements instead of two), do not use the tension-only option and be careful with end releases. Both can easily result in unstable configurations.

## **Extend a Member**

Generate new members along the axis of an existing member to either a specified length or to an intersection with another member (if there is such a member). You may extend the member either forward (local +x direction) or backward (-x). If you extend a member to a specific length and your new member crosses one or more existing members, you have the option of combining your new members with the member to be extended or leaving them as separate pieces.

Note: If your extended members cross plate elements, these will be automatically split (meshed) regardless of your auto-split settings.

## **Snap to Members**

### **Drawing with a Grid**

Members are drawn first to existing nodes, then to grid-points, and then finally to any snap-points visible on the member. You can set the number of snap points on members using the Model Filter.

### **Drawing without any Grids**

If no grids are displayed, you can still sketch members between existing nodes or snap points.

## **Copy Member Properties (Format Painter)**

VisualAnalysis allows you to "copy & paste" member properties.

1. Select a member, use **Home | Copy**
2. Then select any other member elements before using **Home | Format Painter**.

You will be prompted with a small dialog box asking you which properties of the original member you would like copied to the others, such as: Shape, Material, Beta Angle, or other properties. The tool also works in Design View to copy design group properties.

## **Capture Graphics Image**

You can create a bitmap image of the Model View, by using the **Copy** command. This puts an image on the Windows clipboard that you can paste into VisualAnalysis reports or other Windows programs. This is true for all of the graphic views: Model, Results, and Design. You can also copy and paste in one step with the **Add View to Report** command.

The image will be the exact same size and image you see in the window. For the best quality image, make the window as large as possible. Most word processors will scale images nicely to a smaller size for printing, but trying to make the image

bigger there will not improve the quality.

## Printing Graphics

You may also use **File | Print Preview** to send the graphic view to the printer or PDF file. The image is scaled to fit the paper, so landscape mode or changing the shape of the VisualAnalysis window by dragging the border may help you fill the page. Page margins are also used as defined in **File | Page Setup**.

## 2.1.3 Editing Models

### Name Objects

Model objects are given default names when they are created. For example, members that are orientated horizontally in the x-direction are labeled with the prefix BmX-and members that are orientated vertically are labeled with the prefix COL-.

You should provide your own descriptive names to help you find, filter, and sort members of your model. Both the **Filter** tab in Project Manager and the **Find Tool** allow you to filter any visible or listed items by their name prefix.

To name a single object (node, member, plate, or spring), select it in the Model View and use the **Modify** tab of Project Manager to type in a new name. To rename a group of objects use **Structure | Rename**. Although this may take a little extra time initially, it can really save time later by making elements easier to view, edit, and report.

### Rename Objects

The **Structure | Rename** command allows you to rename all objects or selected objects of a single type in one step. The command takes a name prefix, a starting number, and an increment number. You can also specify a directional ordering for the renaming process.

This command can fail if there are already objects with the new name. VisualAnalysis requires that objects of the same type must have unique names.

### Move the Model

This command actually changes the coordinates of your model, not just your view of the model! ([Panning the view](#) allows you to look at a different portion of the model in the window.)

To move the entire model or a selected portion of the model, use **Structure | Move**. This command will move nodes (and anything attached to them) specific distances in the global X, Y, or Z coordinate system.

### Move Nodes

To move nodes and anything attached to them, select the nodes to move. Use the Modify tab in Project Manager and enter a move distance for the X, Y, or Z direction. At present, there is no support for moving nodes in polar or spherical coordinate directions. The Clipboard Exchange tool provides another powerful option for moving nodes in a spreadsheet.

### Align Nodes

You may align a group of nodes to a common X, Y, or Z coordinate. Select the nodes and then enter a new coordinate value through the Modify tab in Project Manager. If you need to align nodes along an arbitrary line, you can do that by drawing a member and splitting it into multiple pieces. Then delete the member elements if you do not need them.

### Copy & Paste

You can select model objects (and loads) and use **Home | Copy**, and then **Home | Paste** to generate multiple copies in either a rectangular or polar fashion. A Generate Copies wizard is presented when you choose the **Paste** command to guide you through the process. Sometimes there is a simpler more direct paste approach in the Context Menu (right-click), especially when pasting loads from one element to another.

## **Rotate the Model**

This command actually changes the coordinates of your model, not just [rotating your view](#) of the model!

You may rotate all or selected portions of the model about any arbitrary point and any arbitrary axis of rotation. Select the portion of the model to rotate and use **Structure | Rotate**. You should note that member orientations are partially defined by the location of the member relative to the global Y-axis. As you rotate the model, you may also be rotating members within the model as well as loads, end releases, and results that depend on the orientation of local coordinates.

## **Split or Merge Members**

You can model [members](#) as one continuous piece, such as a girder with infill beams connecting to it. Or you can split the girder into multiple pieces. Either way, we make sure your FEA model is connected and correct. The implications for you are reduced report sizes, easier result interpretation. There are also significant implications for [design checks](#)--such as unbraced length.

## **Split Plates**

Use this feature to break [plate elements](#) into smaller pieces. Plates are approximate elements. You will often need to refine your model by using smaller plates. This is done by the plates of interest and using **Structure | Split Plate**. Newly created plates are given names based on the original plate.

Internal nodes are created automatically and you have the option to split members that lie along plate boundaries. Normally, you should split members to retain the continuous connection between the two types of elements.

## **Reverse Local Axes**

**Structure | Reverse Local Axes** has the effect of changing the direction of the local coordinate system for the element. This command can be applied to member and plate elements. Local coordinate directions will affect local loads, member end releases, possibly member orientation, and local results.

## **Move a Member in the Model**

Two nodes define a member location. To move a member, while retaining its same connections to the model, simply move the nodes. Select the node and use the Modify tab of Project Manager to change its coordinates. This will also affect all other elements connected to the node.

To change where in the model a member is connected, you should change the member's start node or end node to be a different node. Select the member and use the Modify tab of Project Manager to change its nodes.

## **Change a Member's Length**

The distance between its two nodes defines a member's length. To lengthen or shorten a member, simply move one of the end nodes. Select the node and use the Modify tab of Project Manager to change its coordinates. This will also affect all other elements connected to the node.

## **Change a Plate's Size**

Plate size is defined by the locations of the nodes, to change the size of a plate element, move one or more of these nodes.

## 2.1.4 Creating Models

### [Use a Sketch Grid](#)

VisualAnalysis allows you to draw your members and plates in the Model View. The most effective way to sketch models is to first define one or more Grids to work from. A grid lets you predefine the exact spacing and locations for nodes (joints or connections) in your model. To work with grids, **Click** on the **Grid** tab in Project Manager or use **Home | Grid Manager** menu command.

VisualAnalysis offers a number of different grid types that help you lay out floor plans at given elevations. Normally you will create a number of grids and then enable (show) one or two of those at a time so that you can sketch elements between grid points.

### [Sketch a 2D Model](#)

The easiest way to create models is to sketch them in the Model View. Before you begin you should set up the Sketch Grid and choose between drawing members or plates. Sometimes you might sketch without worrying about exact locations of nodes so that later you can move nodes to correct the geometry. With the Grid turned off, you are only allowed to sketch members or plates between existing nodes in the model. Remember to fix out-of-plane supports when modeling in 2D.

### [Sketch a 3D Model](#)

Sketch a 3D model in two phases. First sketch a wall elevation or a floor plan on a plane of the model. To do this, define a Cut Plane in the 3D space and turn on the Sketch Grid. Rotate the view to see this plane clearly and sketch as you would for a 2D model. Repeat this process for multiple planes in the model, changing the plane center to a different value.

Once you have at least two planes of elements created, you can switch to full 3D sketching. Here you can remove the Cut Plane setting to see the entire model and then rotate the view and sketch between any existing nodes. You could also create a Cut Plane in a perpendicular direction to draw members.

### [Import a DXF File](#)

While sketching is very easy for most models, you might be more comfortable drawing in a CAD package. You may import geometry and connectivity information directly through a DXF file. This is especially useful for complex configurations involving angles, curved structures, or many offsets. The command is **File | Import from DXF**. Note that you may also import a DXF file directly using **File | Open**, however this method does not offer any options on the import and you will get default behavior! [DXF File Details](#).

### [Generate Typical Models](#)

The standard version of VisualAnalysis allows you to quickly generate parametric models of common structures or structural components. Use the Create Tab of the Project Manager to access this feature. The Generate Standard library includes options such as typical trusses, building frames, walls, slabs, floor systems, tanks, and more. You may also add your own parametric definitions for generating the types of models you create often. (See the chapter on Customizing.)

### [Generate Copies](#)

You can copy any selected model objects using **Structure | Generate Copies**. The following list describes some of the many things you can do with the Copy and Paste approach to modeling:

- Generate rectangular, circular, or linear patterns of model objects. For example, copy a floor plan of beams to the next level.

- Generate a "mirror" image of a plane portion of the structure. (By rotating about the vertical axis.)
- Make a separate copy of your model, change it slightly and run a side-by-side comparison with the original model.
- Copy member loads from one member to another within a single load case and scale them.
- Copy loads from one load case to another and scale them if necessary.

## Create Multiple Models

It is often helpful to compare two models side-by-side. You may create two or more separate models in a single project file. This works well for static analysis to see how different configurations or conditions will affect the behavior of simple structures.

Obviously, for large projects you will incur significant performance problems if you try to do this.

## Import from Autodesk Revit

### **Requires: Advanced Level**

IES offers a free add-in utility for BIM integration with **Autodesk**  Revit: see [VA-Revit Link](#).

## 2.2 Model Topics

The structural analysis and design process starts with a model of the real structure. VisualAnalysis offers a convenient environment to construct models of just about any civil/structural project, whether it is a simple beam or a complex facility.

### **Modeling**

- [Project Settings](#)
- [Creating Models](#)
- [Working in Model View](#)
- [Editing Models](#)
- [Nodes & Supports](#)
- [Member Elements](#)
- [Plate Elements](#)
- [Areas](#)
- [Soil Spring Generator](#)

### **Advanced Modeling**

- [Cable Elements](#)
- [Semi-Rigid Connections](#)

### **Limitations**

- [Modeling Limitation](#)

## 2.3 Project Settings

General project settings are found in the **Project Manager | Modify** tab when nothing is selected in the model.

## Project

**Structure Type** - Two structure types are available: Space Frame and Plane Frame. Space Frame models use six degrees of freedom (DX, DY, DZ, RX, RY, RZ) while Plane Frame models only use three degrees of freedom (DX, DY, and RZ), with the others fixed.

**Vertical Axis** - Select a direction to use for vertical. Up is assumed to be the positive coordinate direction selected. This will affect self weight and certain building code load combinations, and graphic rotations. Members are oriented with a local coordinate system that is always based on the global Y, for historical reasons. CAD projects often use Z for vertical which can be accommodated in VisualAnalysis.

**North Axis** - Select one of the global coordinate directions (plus or minus) to be the North direction for the project. This setting is used in the automatic naming of model objects.

**Coordinate System** - Select from displaying coordinates in Cartesian, polar, or spherical coordinates. Polar coordinates can be oriented in 3 different ways. Switch back and forth between the systems as you work with different parts of a model. This affects how coordinate locations are displayed.

**Risk Category** - The risk category selection is only used for the automated building code load combinations for seismic load combinations.

## Analysis

**Static Method** - Select from three different types of static analysis for the project: 1st Order - linear or iterated (for one-way elements), P-Delta - iterated 2nd order analysis, or AISC Direct Analysis - notional loads and reduced member stiffness for K=1 design.

**Mesh Element Area** - Specify the maximum element size for meshing auto-meshed areas. This setting controls how many plate elements get generated in all the auto-meshed areas. Use this setting for mesh refinement to work work towards convergence.

**Meshed Plates** - The number of generated plate elements created during meshing of auto-meshed areas.

**Performance** - Adjust how many places along members where intermediate member results are calculated. This can have a significant impact on analysis and design performance and there is a trade-off with result accuracy. Generally, the **Automatic** setting is a good balance. If there are performance issues, set it to **Fast**. For near perfect moment and shear diagrams, without numerical round-off errors, use the **Academic** setting. There are also **Normal** and **Custom** settings.

## Advanced Analysis

**Neglect Nonlinear** - Ignore one-way effects, semi-rigid ends, and other nonlinear element features. Allows quick mode shape calculations, or state analysis of models that are unstable with one-way elements.

**Lock Zero Stiffness** - Should an infinite spring be placed at degrees of freedom which have zero stiffness? Please use this option carefully and note that if there is zero stiffness at a degree of freedom it could be resulting from more serious modeling error.

**Return Unconverged Results** - For a limited buckling or push-over analysis. Turning this on allows VisualAnalysis to iterate a second-order analysis under ever-increasing loads to find out which loading-level causes failure. When the numerical solution fails it may be an indication of buckling. For a true buckling analysis you may need to split members into multiple pieces to get accurate results. Also, because VisualAnalysis does not handle material-effects such as yielding or crushing, the results may not be conservative.

**Force and Displacement Tolerance** - Convergence of a nonlinear analysis involves looking at errors in both displacements and unbalanced nodal forces. In order for nonlinear analysis results to be acceptable (i.e. converged), these errors need to be smaller than a chosen tolerance. For displacements, this is a unitless value and involves dividing the incremental displacement correction vector norm by the total displacement vector norm. Unbalanced nodal forces are calculated by taking



the element forces that frame into a node minus the applied load node forces. These form a vector as well and the check is similar to the displacement check in that it is the norm of the unbalanced force vector divided by the total applied load vector norm (unitless).

**Nonlinear Iteration Limit** - Maximum number of convergence iterations to try during nonlinear analysis.

**Load Stepping Points** - Number of stepping points per member for moving load truck placement (a performance vs. accuracy setting).

## IBC Seismic Loading

These settings are only used in VisualAnalysis to generate building code load combinations. They are all items defined in ASCE 7 (and referenced by IBC).

**SDS** - The design spectral response acceleration at short periods as defined by ASCE 7.

**Category** - The Seismic Performance Categories as defined by ASCE 7.

**Overstrength X/Y/Z** - Parameter for system and members requiring overstrength factors as defined by ASCE 7.

**Redundancy X/Y/Z** - Factor for structure exhibiting redundant features as defined by ASCE 7.

## Design Checks

**Auto-Group Members** - VisualAnalysis automatically creates groups for members based on material, orientation, length, and/or cross-section for design checks.

**Auto-Mesh Plates** - VisualAnalysis automatically creates meshes (groups) for plates based on material, orientation, and/or thickness for design checks.

**Auto-Stress Checks** - Stress-check design groups are created automatically for ungrouped members, such as those with custom shapes, tapers, or materials not supported by built-in design checks.

**Auto-Connections** - Connection groups are automatically created for export and design in [IES VAConnect](#).

**Metric Rebar Sizes** - Use metric rebar sizes (e.g. 10M) instead of USA traditional sizes (e.g. #3).

**Export Results Type** - When exporting connection-design forces to [VAConnect](#) or [QuickFooting](#) select whether VisualAnalysis should export service case or load combination results. These results from VisualAnalysis become loads in the design tool. Exporting of service case results is usually better for these tools, but if the project is nonlinear or contains more sophisticated results that need checking, export the results as prefactored into these tools. This setting has no effect on exports to [VisualFoundation](#), which always (and only) uses the service-level reactions.

## Miscellaneous

**Title** - Optional descriptive name for your project. If left blank, the filename for your project becomes the title.

**Billing Reference** - Optional name or number used for your internal business purposes, this number will appear on reports.

**Project Notes** - Optionally enter a description, notes, thoughts, or information that you can include in a report and that is saved with the project to help you remember what you need to do, or why you modeled something a certain way, or anything else you need to remember.

**Nodal Tolerance** - Specify how close nodes can be placed before VisualAnalysis combines them.

**Beam Top @ Nodes:** Set beams to have an automatic offset in the vertical direction equal to half of their depth (nodes are at the 'top' of the member). You may still use additional manual centerline offsets. Only applies to members with a framing type of 'beam'.

**Offset Add Stiffness?** - Should member offset add stiffness to the member or just affect the graphic

view?

**License** Information on who holds the license, the company, the license type, and the product level.

## 2.4 Nodes and Supports

Nodes define locations of elements, provide an FEA link between elements, and function as external supports. Nodal supports are aligned with the global coordinates and have either a free or fixed degree of freedom in each direction. To edit a node, [select](#) it in the Model View, and change the properties in the **Project Manager | Modify** tab. Multiple selected nodes can be edited at the same time. Use a [Spring Supports](#) when an elastic support or a support with a skewed orientation is needed.

### Global Coordinates

The global coordinate system is shared by all entities in the model. VisualAnalysis has a single global coordinate system and nodal coordinates are specified relative to the global system. Global coordinates are always represented with these upper-case letters (X, Y, Z). VisualAnalysis also uses [element local coordinate](#) systems that are distinct to each element. It is important to understand the difference between element local coordinates and the global coordinates. Some data (both input and output) is defined relative to the global system while other data is defined relative to an element's local system. Global Cartesian coordinates (X,Y,Z) are used by default, but polar coordinates (R, Theta) and spherical coordinates (R, Theta, Phi) are also available in the **Project Manager | Modify** tab.

### Degrees of Freedom

Depending on the chosen structure type (Space Frame vs. Plane Frame), nodes may move or rotate with respect to the global coordinate system. Degree of freedom is defined as the ways a node can move or rotate. In Space Frames, nodes can translate in 3 directions (DX, DY, and DZ) and rotate about 3 axes (RX, RY, and RZ). In a Plane Frames, nodes can translate in 2 directions (DX, and DY) and rotate about 1 axes (RZ).

### Creating Nodes

In VisualAnalysis, nodes do not need to be explicitly made as they are created automatically when members, plates, and cables are created or when models are imported. There are several ways to create nodes in VisualAnalysis:

- Use the **Structure | Create Nodes** button (or the **Ctrl+Shift+1** hot key) for instant access to the Multiple Node Creation dialog box. Enter the coordinates manually or import the coordinates using the Windows Clipboard (Copy/Paste).
- On the **Project Manager | Create** tab, **double-click** on Add Nodes, Singly or Locate Multiple Nodes.
- Create a new grid or edit an existing grid on the **Project Manager | Grid** tab to define the locations for potential new nodes and draw members, plates, and/or cables between gridlines.
- Use the **Structure | Create Members** command or the **Project Manager | Create | Add Member** command to create members with new node new or existing nodes.
- Select an existing node or element and use **Structure | Generate Copies** or **Ctrl+B** to generate copies.
- Import a DXF file. When members or plates are imported, the associated nodes are automatically created.
- Use the **Structure | Extend Member** feature to create a new node and member at a specified distance from the existing member.
- Use the **Structure | Split Member/Plate/Cables** commands to split elements and create new nodes.

### Nodal Tolerance

As models are created and nodes are generated, two nodes will sometimes be created at almost the same exact location. VisualAnalysis provides a feature to control how close together nodes are before they are considered 'identical' and an existing node will be used instead of generating a new node. Use the **Project Settings | Nodal Tolerance** to define the desired tolerance for the project (1/16th of an inch is used by default). Avoid setting this to a large value (VisualAnalysis limits 36 inches maximum) which might cause tolerance issues. If problems with duplicate nodes arise, adjust the Nodal Tolerance and run the **Structure | Consolidate Close Nodes** command to find and merge duplicate nodes.

## Free or Supported?

Nodal supports are used to restrain the entire structure against rigid body translation or rotations and typically are found at the bases of columns. Common supports are pinned allowing no translation, or fixed allowing no movement at all. First-time users of VisualAnalysis will often confuse nodal supports with "Joints" or "Connections" between members. Member connections are defined by the [Structure-Type](#) and [End Releases](#) for a member. A support should only be used at a location where load is taken out of the model or where there is a nodal displacement. Do not support nodes at locations where external loads are applied. Also, do not support nodes in directions where spring supports have been placed as this will render the spring support ineffective.

## Scissor Joints

Scissor joints are used where all member translate the same amount but parallel members sets will rotate independently of each other. Select the node where members cross, and check the **Scissor Joint** option in the **Project Manager | Modify** tab.

## Nodal Mass

Additional lumped mass can be applied to nodes in the model. Note: Mass is input as a Force which is convenient when using the English unit system. This mass is only used for dynamic inertial effects and is not used in any static analysis. Self-weight of elements is defined by element properties and other dead loads should be applied as service case loads on nodes or elements. For more information about mass, see [Dynamic Analysis](#).

## Nodal Results

Nodal results include displacements or rotations for unsupported degrees of freedom and reaction forces or moments for supported degrees of freedom. The global coordinate sign convention is used for reactions and displacements, where a positive reaction is in the direction of the global axes or the right-hand rule for rotations. Nodal settlements or nodal rotations can only be applied to a fixed degree of freedom and the reaction is calculated for the applied displacement or rotation.

## Disconnected Nodes

Use the **Tools | Model Check** command to find unconnected nodes in the model, as they tend to be graphically small and can be hard to find in a complex project. Use the **Tools | Fix Model** command to remove unconnected nodes in the model.

## Spring Supports

Spring supports are used when the restraint at a node is between free and fixed. Spring supports can be manually created at each node or the [Soil-Spring Generator](#) can be used to generate springs under plate elements.

- Use the **Structure | Create Spring Supports** command to create springs for selected nodes.
- Select one or more nodes graphically, then **double-click** the Add Spring Supports item in the **Project Manager | Create** tab.

# VisualAnalysis 19 User's Guide

- Use the **Structure | Generate Soil Springs** command to generate soil springs for a group of selected plate elements. [Details](#).

## Spring Directions

Translational spring supports can be oriented along lines parallel to the global coordinate system (+X, -X, +Y, -Y, etc.) and are specified by direction cosines. When aligned with the global axes the cosines are either zero or plus or minus one. Complex math expressions such as  $\text{COS}(3/\text{SQRT}(3*3 + 12*12))$  can be used when entering cosines.

## Elastic Supports

Spring supports are often used to model support conditions that are not truly rigid. For example, many soil-based footings have some elastic compression behavior that results in support settlement. When these cases exist, place a spring at the support node and set its stiffness relative to the soil elastic properties. To model a compression-only or tension-only support, the spring will need to be correctly oriented to get the desired behavior. Spring supports take load out of a structure and should be used as external support only. They should not be used to modeling partially rigid connections between elements.

## Spring Results

Spring element output is based on the following sign convention. For displacement springs, a positive force is tension and a negative force is compression. For rotational springs, a positive moment indicates the spring is being twisted according to the right-hand-rule.

## 2.5 Member Elements

VisualAnalysis members consist of 2-noded prismatic (or linear depth-tapered) line finite elements. These elements can be used to model frame or truss members. For member elements, the axial displacements are based on a linear displacement assumption and the transverse displacements are based on a cubic displacement assumption. Shear effects are included only for user-defined sections with nonzero shear areas. Special cases such as end zone are all handled internally using multiple member elements (creating a combined member). [Select](#) one or more members to view or edit the member properties in the **Project Manager | Modify** tab.

### Creating and Modifying Members

Members can be created using the **Structure | Draw Members** command to draw members on a Grid or to existing nodes in the model. Also, the **Structure | Create Members** command can be used to make members based on a the start and end coordinates which can be input by the user or defined by existing node. After members are created, they can be Extended, Trimmed, Merged, or Split using the commands in the Actions section of the Structure tab in the Ribbon as defined below.

- **Extend Members** - Generates a new member along the line of the existing member.
- **Trim Members** - Trims members down to crossing members, plates, or areas.
- **Merge Members** - Creates one member from a chain of selected member elements (the elements must be collinear for this feature to work).
- **Split Member** - Divides a member into multiple pieces, inserting nodes and splitting loads.

### Coordinate Systems

In VisualAnalysis, a **Global Coordinate System** is defined for each project, a **Local Coordinate System** is defined for each member, and a **Geometric Coordinate System** is defined for each shape. This section discusses the difference between these coordinate systems and how they are related. To understand how members are oriented in a project, it is useful to

turn on the Local Axes, the Axes (global), and the Picture View and in the [Project Manager | Model Filter](#) tab.

## Local vs. Global Coordinate Systems

In VisualAnalysis, member's local coordinates are always represented with lower case letters {x, y, z} whereas global coordinates are represented with upper case letters {X, Y, Z}. The local coordinate system aligns with principal axes of the member's assigned shape and is used to define loads, end releases, and results. When a member is created, the local x-axis is defined from the start node to the end node and the local y-axis typically lies in the plane formed by local x-axis and a vector parallel to global Y-axis (see the figure below). When the local x-axis aligns with the global Y-axis, the local y-axis is opposite the global X-axis and when the local x-axis is opposite the global Y-axis, the local y-axis is aligns with the global X-axis (see the figure below). The local z-axis is defined from the local x-axis and y-axis using the right-hand-rule. The local coordinate system for a member can be reversed using the [Structure | Reverse Local Axes](#) command (the start and end nodes are simply swapped).

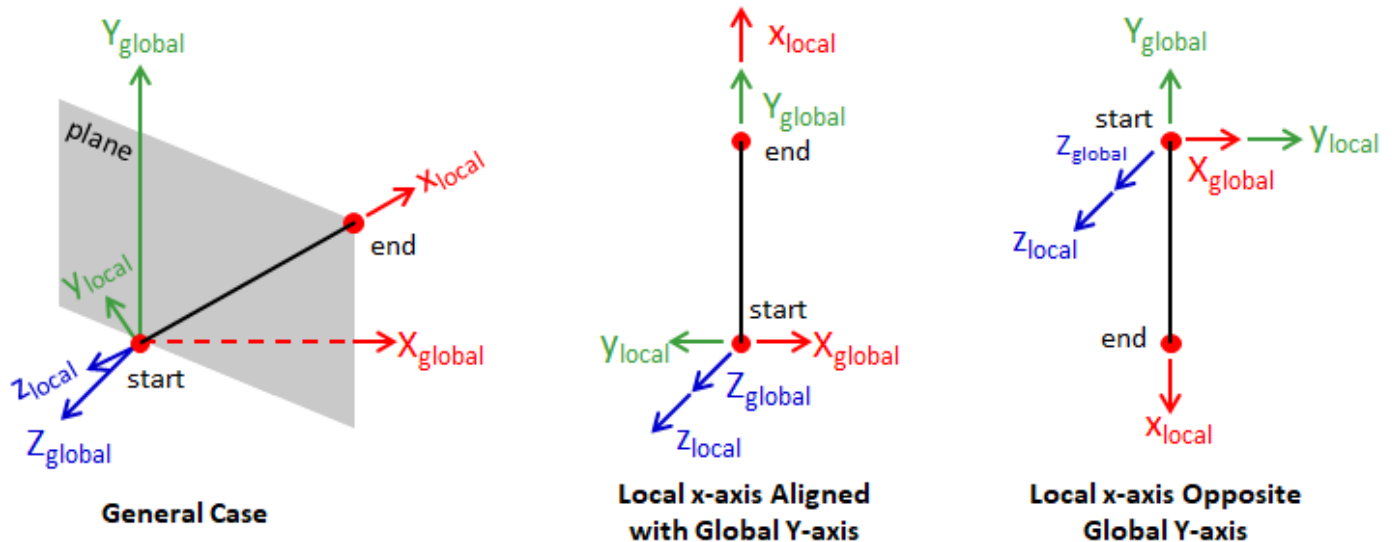

## Geometric vs. Local Coordinate System

The shapes used to define members in VisualAnalysis have a Geometric Coordinate System ( $x_{geo}$  and  $y_{geo}$ ) as shown for several shapes in the figure below. For parametric shapes, the Geometric Coordinate System is shown in the Parametric Shape Dimensions dialog box in VisualAnalysis. Members in VisualAnalysis are modeled such that the  $z_{local}$  axis and the  $y_{local}$  axis align with the shape's major and minor principal axis, respectively. **Therefore, the member's Local Coordinate System does not align with the shape's Geometric Coordinate System as illustrated below.** The Principal Angle ( $\alpha$ ) is defined as the angle between the cross-section's geometric x-axis ( $x_{geo}$ ) and the major principal axis ( $z_{local}$ ) where a counter-clockwise rotation is positive. The Principal Angle is zero or 90 degrees for symmetric cross sections. For asymmetric shapes (e.g. single-angles, zees, spandrels, etc.), the shape's principal axes do not align with the geometric axes. When the Principal Angle is non-zero, it is displayed in the [Project Manager | Modify](#) tab. The figure below shows the principle angles for the various cross-sections.

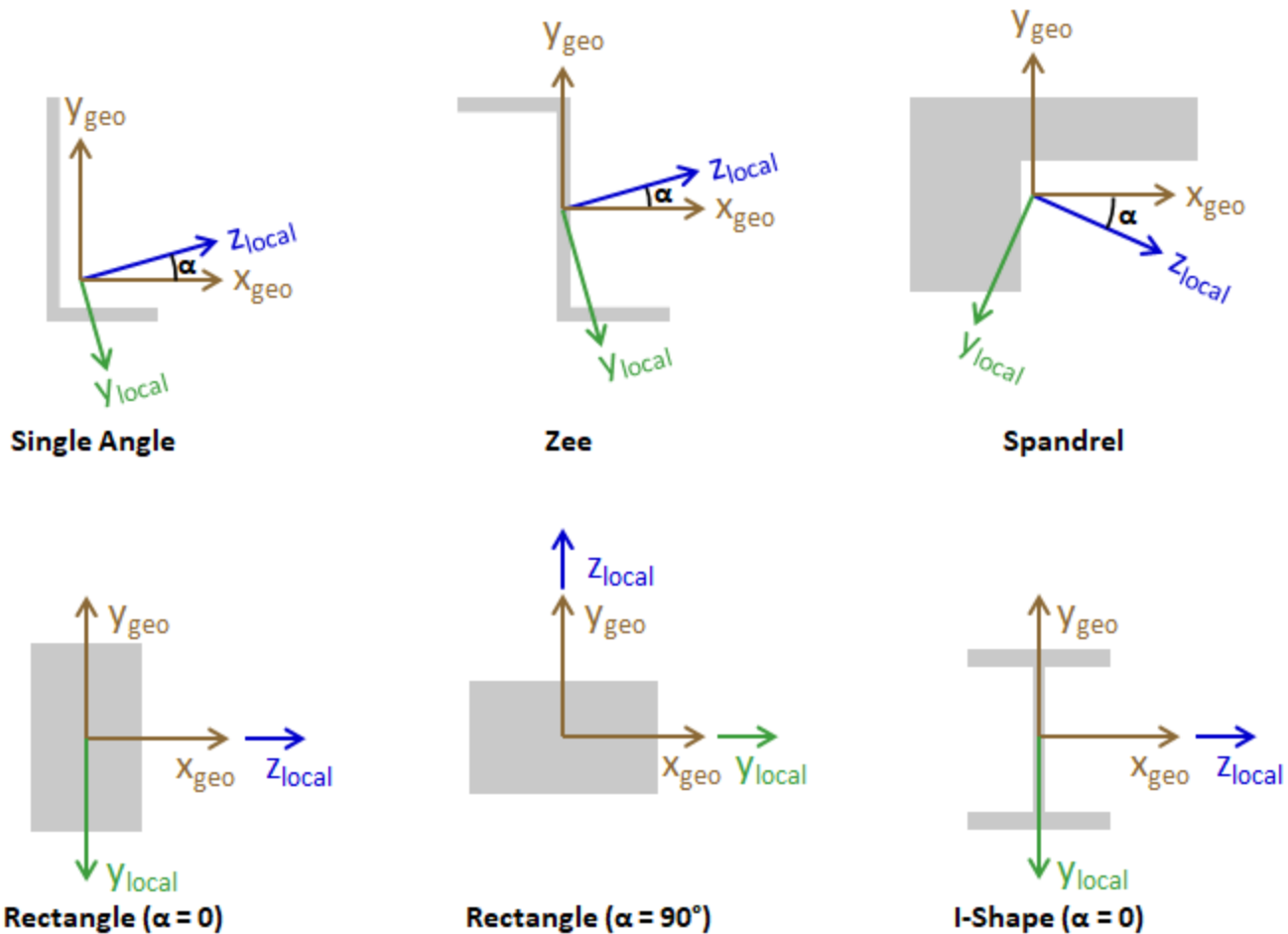

## Shapes

The shape for a member is defined on the **Project Manager | Modify** tab when one or more members is selected. There are five types of shapes available for use in VisualAnalysis: Database Shapes, Standard Parametric Shapes, Custom Shapes, Analysis Blobs, and Rigid Links. Custom Shapes are created in [IES ShapeBuilder](#) and added them to the [CustomShape Database](#).

### Database Shapes

IES includes a large [Shape Database](#) of steel, wood, aluminum, cold-formed, and other shapes common in the USA and some other countries. The database is customizable using [IES ShapeBuilder](#), but cannot be modified directly using VisualAnalysis. Selecting a database shape will typically also define material and therefore it is best to define the shape prior to defining the material. The shape database contains Virtual Joists and Virtual Joist Girders which are developed by the [Steel Joist Institute](#). Their website has information on the basic concept and purpose. You may create models with these shapes and get design-checks as if they were steel beams (please understand their purpose and limitations before using them).

### Standard Parametric Shapes

Parametric shapes are defined by dimensions such as width, depth, and thickness, which are input by the user. Parametric shapes are commonly used for defining concrete members (e.g. square, rectangle, round, etc.). In general, parametric Shapes are supported for design checks, however, there are some limitations. VisualAnalysis offers the following types of

parametric shapes: Angle, Channel, Circle, I-Shape, Pipe, Rectangle, Rectangular Tube, Spandrel, Tee, and Zee.



## Custom Blobs (Requires Advanced Level)

Custom Blobs are a quick way to defined the numerical properties of a shape that are needed to perform the analysis (the actual dimensions of the shape are not defined). Custom Blobs are only available in the project in which they were created (i.e. they are not added to the shape database). Use Custom Blobs with care as the shape properties are not checked other than to ensure they are positive. Custom Blob members have many limitations including they cannot be tapered or used for design (except for [Generic Deign Groups](#)).

## Rigid Links (Requires Advanced Level)

Rigid links are a short, stiff member element used to connect two nodes at some offset and to control the transfer of forces between elements framing into those nodes. By changing a member into a rigid link, VisualAnalysis will automatically take care of the member's stiffness. End releases are the only parameter that can be defined by the user for rigid links.

## Quick Shape Pick List

The **Project Manager | Modify** tab shows the types of shapes available in the Source drop-down list: Standard Parametric, Database Shape, Rigid Link, <Add Custom 'Blob'...>, <ShapeBuilder>, followed by a list of shapes that are already used or have been recently used in the project. Use this list to quickly find a shape for a new member element.

## Materials

Material properties come from the IES material database, which includes the most common structural materials. Materials for selected elements are set in the **Project Manager | Modify** tab. All materials in VisualAnalysis are linear, elastic, and isotropic. Select a shape before selecting a material as most database categories have a default material that will be automatically assigned the shape is selected (i.e. if the material is specified first, it might get replaced). If the database does not contain the desired material, simply create a custom material.

## Custom Materials

Add custom materials by clicking the **Add Custom Material** button in the Material Database dialog box. Specify the material "type" to define custom materials categorized as wood, steel, concrete etc. that will work for the corresponding design checks. After selecting a material type, defining properties as needed or use the default values. If some of the defining properties for a material type are unknown, consider using a General material type where only four basic material properties need to be defined: the modulus of elasticity (E), Poisson's ratio (Nu,  $\nu$ ), the weight density (Gamma,  $\gamma$ ), and the coefficient of thermal expansion (Alpha,  $\alpha$ ). The Shear Modulus, G, is calculated internally as:  $G = E / (2*(1 + Nu))$ .

## Stiffness Factors

The torsional, axial, and flexural stiffness of selected members can be factored in the **Project Manager | Modify** tab to increase or decrease the stiffness of the members in the model. Adjusting the stiffness of the members allows the user to easily analyze concrete members using cracked moments of inertia, analyze steel members with reduced stiffness to account for residual stresses, etc.

## Connections, Releases, and Semi Rigid

# VisualAnalysis 19 User's Guide

In VisualAnalysis, member connections in a Space Frame model are rigid by default (i.e. full force and moment transfer exists between the member, the joint itself, and all other members with rigid connections framing into the joint). Member releases are always specified in the member's [Local Coordinate System](#). Depending on the connection, members in reality are not always capable of transferring certain forces or moments at their ends. For example, a steel beam connected to a column with a simple shear connection is not capable of transferring large moments to the column. To model this situation, a moment release should be used at the end of the beam. Use the **Project Manager | Modify** tab to adjust the Connections and Releases for the selected members in the model. The following common Connection Types can be selected from the drop down menu to automatically populate the Releases for the member.

- **Simple Connect** - Moment is released  $M_z$  and  $M_y$  for both ends of the member (e.g. a simple shear steel connection)
- **Rigid Connect** - No releases exist at both ends of member (e.g. a fully restrained moment steel moment connection)
- **Simple - Rigid** - Simple connection at Node 1 and Rigid connection at Node 2.
- **Rigid - Simple** - Rigid connection at Node 1 and Simple connection at Node 2.

The Simple Connect connection type is commonly used to model truss members (keep in mind that truss members can still experience moment when loaded between the nodes). For more complicated conditions, automatically set the Releases for each end of the member and the Connection type will automatically switch to <See Releases>. Force releases can be used in situations where force cannot be transferred in a particular direction (e.g. due to slotted holes in a steel connection). When a connection cannot be defined as Rigid or Released (e.g. for a partially restrained moment connection), use the [Semi Rigid](#) options in the **Project Manager | Modify** tab to specify the stiffness of the connection for strong or weak bending. When a member is selected, the member releases are shown in green at the end of the member.

## Stability Issues

When releases are incorrectly used the model can become unstable and VisualAnalysis will not be able to perform the analysis. One common mistake is for a Simple Connection to be used at a pinned support as shown in the figure below. For this case, the node can spin in the model since the support provides no rotational support and the member only provides rotational support about the local x-axis (since  $M_x = \text{rigid}$ ). For more on stability issues, see [My Model is Unstable](#).

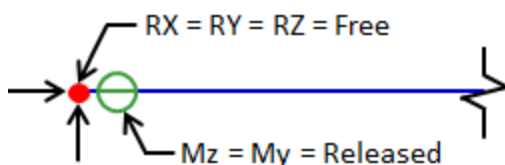

**Spinning Node Stability Issue**

## Connect Crossings

When enabled, the Connect Crossings feature allows members to automatically connect to any element or node that crosses the member (when no node is present at the crossing, an auto-node will be created as shown in the image below). When the Connect Crossing feature is disabled, no force will be transferred between the member and the crossing element. When two members cross, the Connect Crossings feature must be enabled for both members for the connection to be made. Tension Only and Compression Only members do not have the Connect Crossing feature. Crossing Connections can be shown or hidden in the model in the Member Details section of the **Project Manager | Filter** tab.



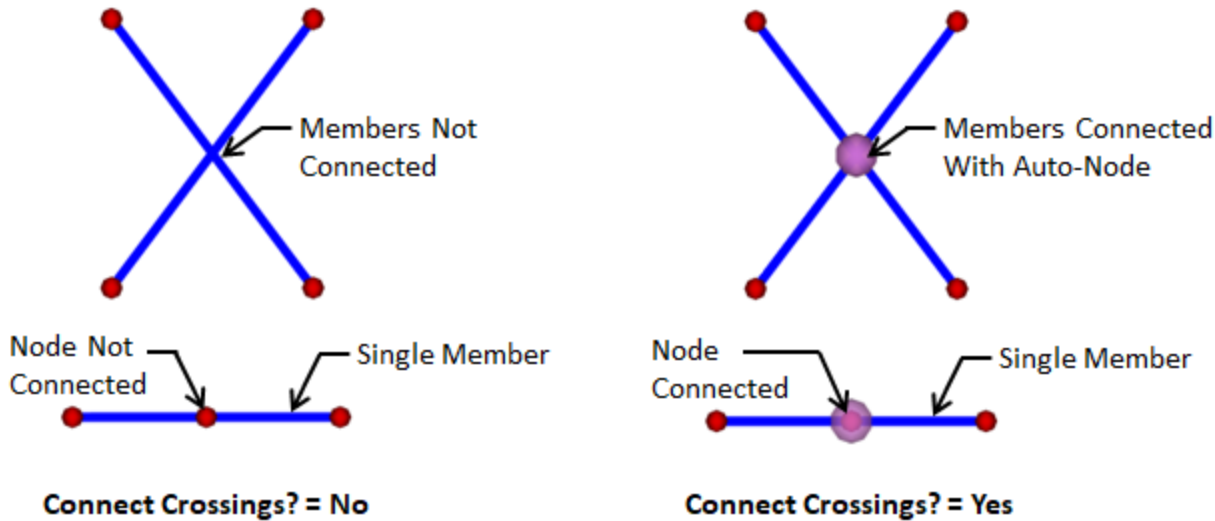

## Member Options

### Beta Angle

If a member is not oriented correctly in the model (i.e. if the top of the shape do not coincide with the "top" of the building), simply adjust the Beta angle for the member in the **Project Manager | Modify** tab. The Beta Angle changes the orientation of the local coordinate system by rotating the section about the local x-axis (positive rotation follows the right-hand-rule). By default, the Beta Angle for asymmetric members is set equal to the [Principal Angle \(alpha\)](#) so that the geometric axes align with the global coordinate system as shown below. Understanding the shape's orientation is crucial for understanding the analysis results of a member and for performing member design. Understanding the shapes orientation is also vital when defining the reinforcement for [Concrete Beams](#).

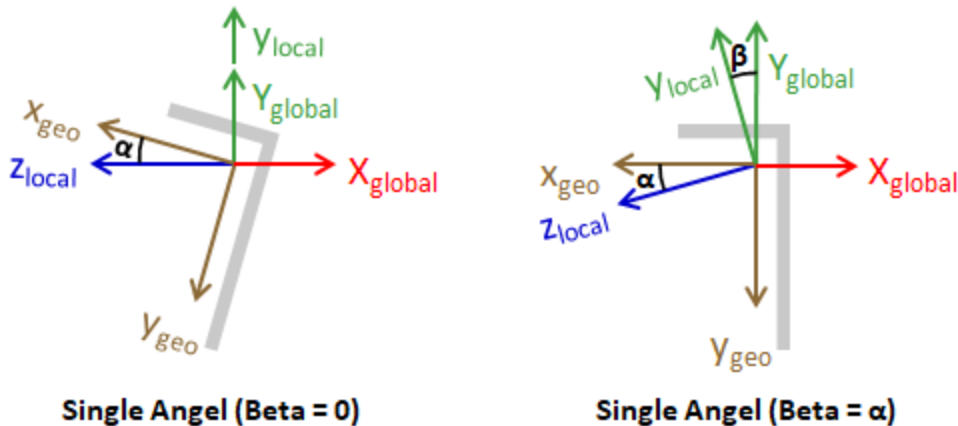

### Two-Way vs. One-Way Behavior

When selected, members in VisualAnalysis can be set to behave as Tensions only, Compression only, or Normal (2-way) in the Options section of the **Project Manager | Modify** tab. By default, members are set to Normal (2-way). Note: A tension-only member is different from a [cable element](#), which sags and can have pretension. Slender bracing members such as a rod that will buckle under a small axial compression are modeled as tension-only members. In some cases, one way behavior is not permitted such as:

- The member is Combined

# VisualAnalysis 19 User's Guide

- The member lies in the plane of an auto-meshed area
- There is another nonlinearity in the project (e.g. P-Delta, Semi-rigid ends, etc...).

## Framing Type

Each member is designated as one of three framing types (Beam, Column, or Bracing). The framing type is automatically set for members based on the vertical axis setting and the orientation of the member when it is created (changing the orientation of the member after it is created will not cause the framing type to change). Select a member to change its the framing type in the Options section of the **Project Manager | Modify** tab. A member's framing type impacts the following:

- Braces may be excluded from receiving area loads
- Columns are included in drift reports
- Beams will utilize the beam "top of steel" project setting
- Member Graphs will initialize based on the framing type
- Other report tables may filter on this setting

## Member Offsets

Member offsets affect members visually and can also increase the stiffness of the member in the model. To offset a member, select the member in the Model View, choose the Offset Coordinates, and specify the offset values. By default, the Offset Add Stiffness? parameter is disabled in the Project Settings and offsetting members only influences the model visually. It is important to remember that while the picture view shows a 3D image of the member, the member is modeled with a line element. When the Offset Add Stiffness? parameter is enabled, the line element is offset and rigid links are used to accommodate the offset. Boundary conditions can have a significant effect on member forces when offsets are used to add the stiffness to the model. It is important to always validate the analysis results prior to designing members in VisualAnalysis, especially when using offsets to increase the member's stiffness. The figure below summarizes how the Offset Add Stiffness? parameter affects member forces with various boundary conditions when member end offset exist.

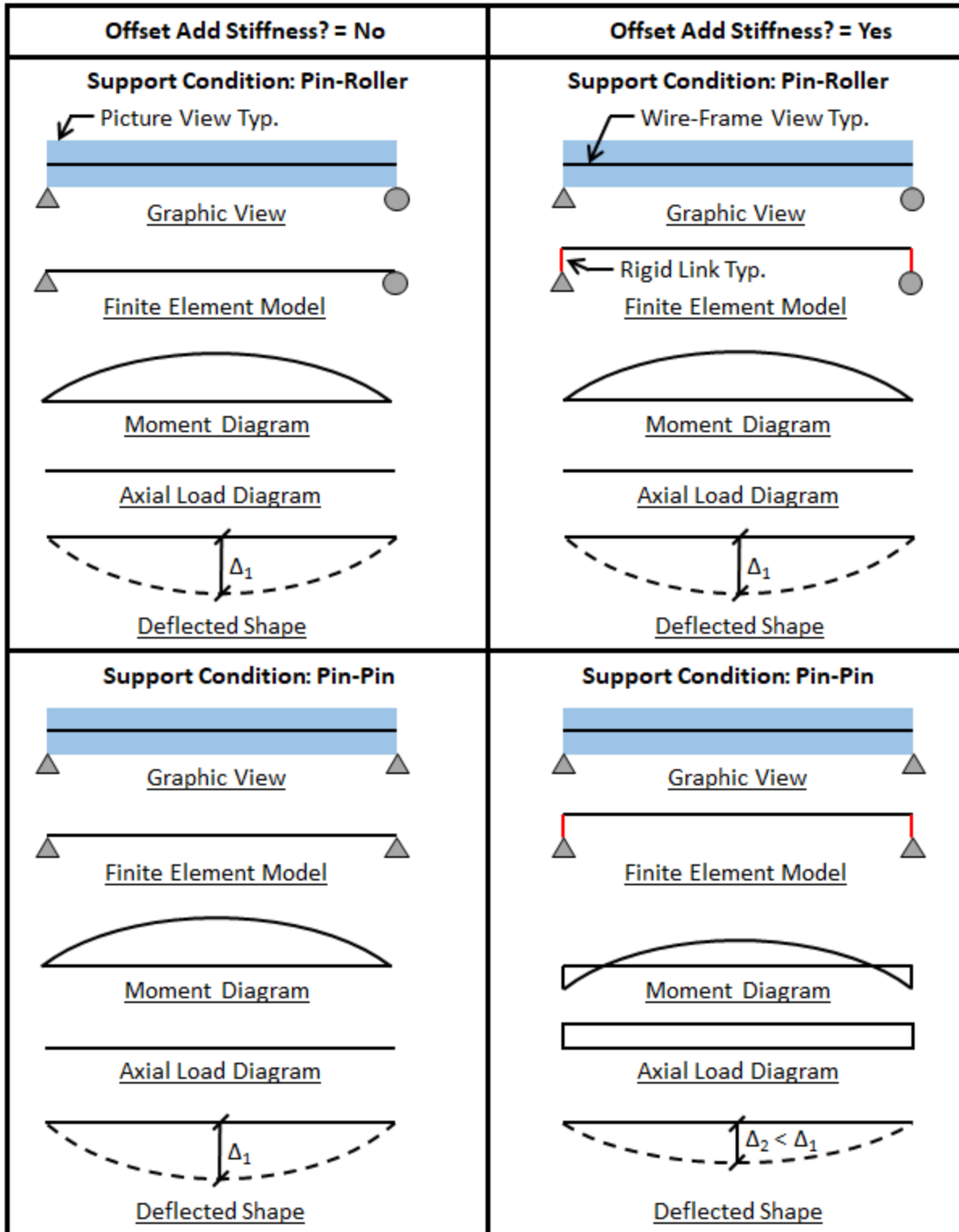

**Member Offsets - Composite Steel Beams**

Member offsets are commonly used to model the increased stiffness that results from composite action between steel beams and concrete slabs. When the beam is offset in these systems and the Offset Add Stiffness? parameter is enabled,

# VisualAnalysis 19 User's Guide

rigid links connect the beam element to the plate elements as shown in the figure below. While this model can approximate the stiffness of the composite system for positive bending (i.e. the concrete slab is in compression), the forces in the beam element may not accurately represent the forces for the composite system (e.g. significant axial forces may be present in the beam and the moment may be underestimated for composite design). When using this approach, the analysis results from the composite system may not be suitable to design the composite beam in VisualAnalysis. Alternatively, the increased stiffness of the composite or partially composite system can be accounted for in the model by applying a [stiffness factor](#) to the beam element without explicitly modeling the slab. This method allows the stiffness to be increased without creating an undesirable force distribution in the member. Care should be used when modeling composite steel beams with negative moments (i.e. the concrete slab is in tension) as cracking of the concrete can lead to significant changes in the stiffness of the composite section which are not accounted for in the model. Note: To effectively use the [Composite Steel Beam](#) design module for both strength and deflection checks, only the steel member should be modeled. The stiffness from the concrete slab or from member offsets should not be included in the model as these will be automatically accounted for in the design checks.

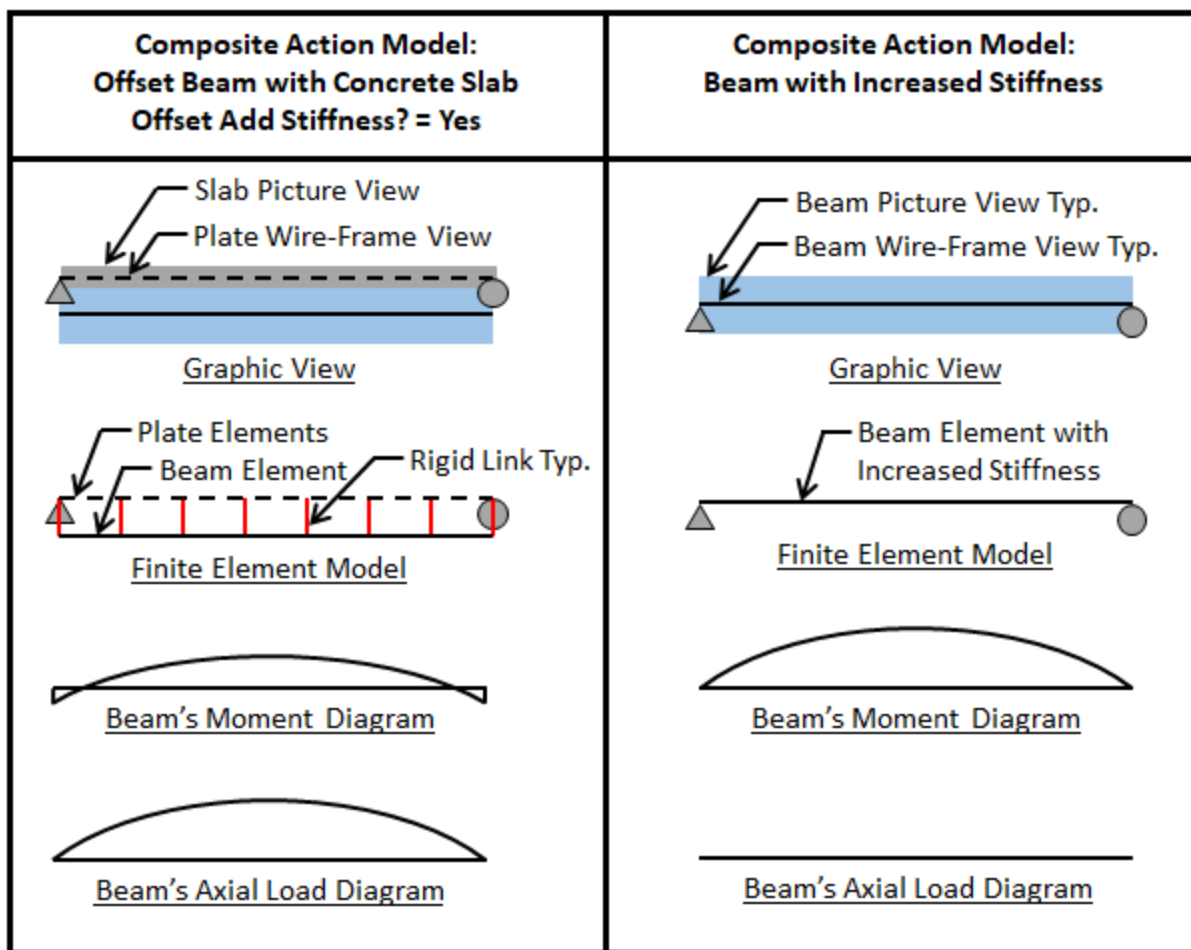

## Beam Top @ Nodes (Project Setting)

The Beam Top @ Nodes project setting causes all the beams in the project to be offset in the vertical direction by half their depth (nodes are at the 'top' of the member). When the Offset Add Stiffness? parameter is disabled, this setting only influences the beam's location graphically. When the Offset Add Stiffness? parameter is enabled, this setting influences the beam's location graphically and influences the stiffness of the beam as explained in Member Offsets. When the Beam Top @ Nodes parameter is enabled, the option is also given to ignore the manually specified y-direction beam offsets using the Ignore Beam Offsets parameter.

## Tapered Members

VisualAnalysis allows members to have a single or double linear depth variation along the length of a member. The defined shape of the member is the starting depth (Depth 1) and the Depth 2 is the value input by the user to define the end of the taper offset. The stiffness of the member is calculated using the depth of the member at any point along the member's length. The Start Fraction  $x$  and End Fraction  $x$  offsets (measured from the starting node for the single-taper, and from both ends for the double-taper) can be adjusted to specify the location where the taper begins and ends. By default the offsets are set to zero and the Depth 2 is at the member's end node. The centerline, bottom, top specification for taper type affects the members graphically but does not affect the member's stiffness.

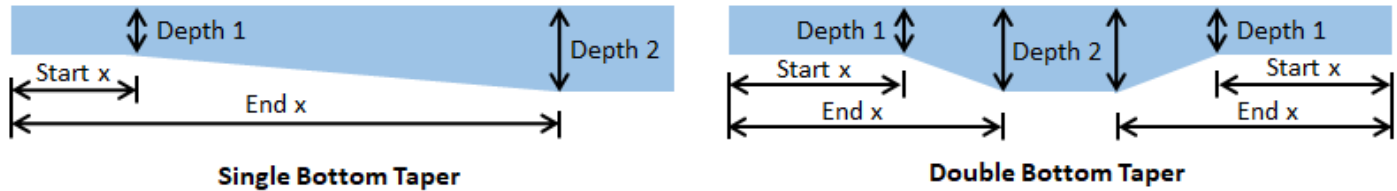

## Taper Limitations

- Not all member shapes can be tapered. Standard parametric shapes and most database shapes that correspond to a standard parametric profile can be tapered. Cold-formed shapes, custom blobs, and double angles are examples of shapes that cannot be tapered.
- Members with crossings or intermediate nodes cannot be tapered (members must be split into individual elements in order to use the taper feature).
- The width or flange-thicknesses of the a shape cannot be tapered.

## End Zones

By default, connections in VisualAnalysis are modeled at the centerlines of the members. End zones (also know as panel zones) can be modeled in the program using the End Zones feature in the **Project Manager | Modify** tab for selected members. For structural steel moment connections, panel zone has some flexibility which can be modeled. When a concrete beam frames into a stiff wall or column, it may be desired to model the end zone as rigid. To specify end zones enter the Width (the distance along the length of the selected member) of each end zone and set the End Zone to Flexible or Rigid. Internally, VisualAnalysis creates a member of the specified length at the end of the selected member and adjusts the stiffness of the member accordingly. When Flexible is selected, a percentage of the member stiffness is specified to be used for the end zone. When rigid is selected, VisualAnalysis uses a multiplier of 1000 on the member stiffness to determine the end zone member stiffness.

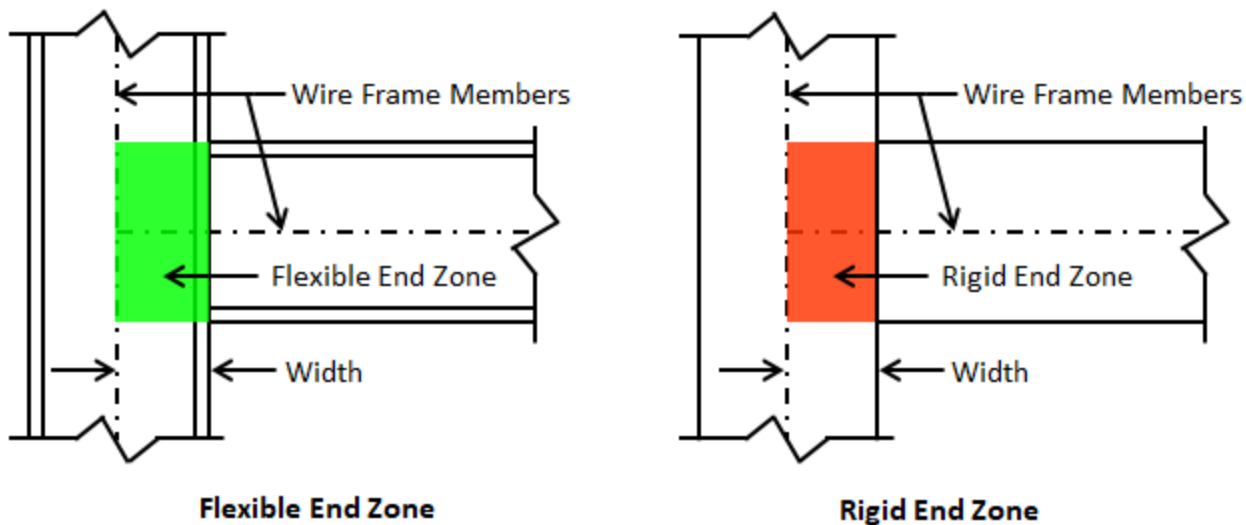

## Analysis Results and Sign Conventions

### Member Local Forces and Displacements

Local member forces using the following sign convention:

- **Axial Forces** - Tension is positive and compression is negative.
- **Shear** - On a positive local x-axis face, positive shears are in the opposite directions of the positive local coordinate directions as shown in the image below.
- **Bending Moments** - Positive bending about the local z-axis produces compression in the positive local y-axis direction. Positive bending about the local y-axis produces compressive stresses in the positive z-axis direction.
- **Displacements** - Positive local displacements are in the same directions as the positive local coordinate directions.

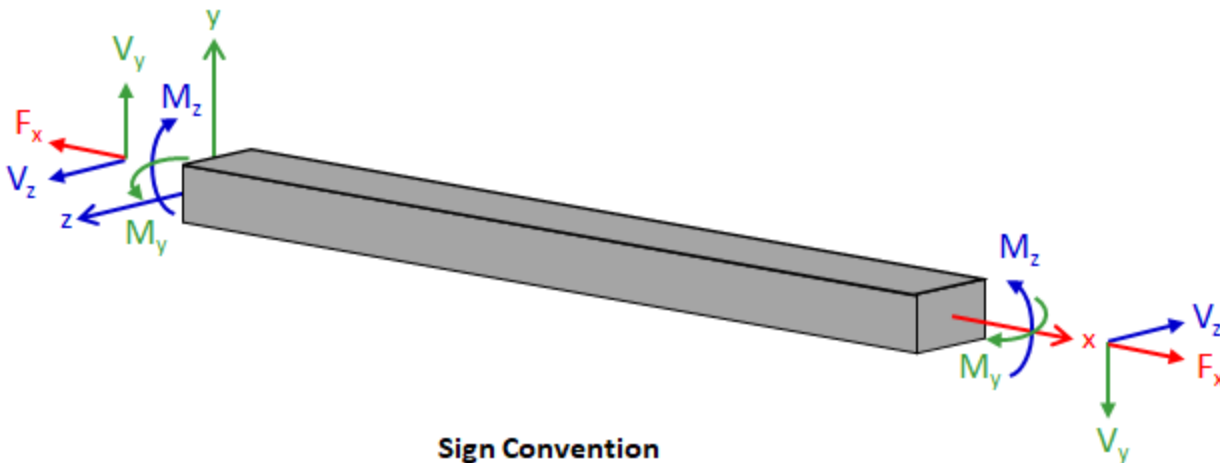

### Internal Member Stresses

Axial stress ( $f_a$ ), bending ( $f_b$ ), and combined axial and bending stresses ( $f_c$ ) are reported for members in VisualAnalysis. Shear and Torsional Stresses are not calculated in VisualAnalysis but can be found using [IES ShapeBuilder](#).

- **Axial Stresses ( $f_a$ )** are calculated assuming that the axial force,  $F_x$ , is applied at the centroid. Therefore,  $f_a = F_x/A$

where  $A$  is the cross-sectional area. Axial stress are positive and compression stresses are negative.

- **Bending Stresses (fb)** are calculated and reported with respect to the [local axes](#), which are the principal axes of the member's shape. Therefore,  $fbz(+y) = Mz/Sz+$ ,  $fbz(-y) = Mz/Sz-$ ,  $fby(+z) = My/Sy+$ , and  $fby(-z) = My/Sy-$  where  $Mz$  and  $My$  are the moments and  $Sz+$ ,  $Sz-$ ,  $Sy+$ , and  $Sy-$  are the section moduli to the extreme fiber ( $Sz+ = Iz/y+$ ,  $Sz- = Iz/y-$ ,  $Sy+ = Iy/z+$ , and  $Sy- = Iy/z-$ ). The bending stresses are shown in the image below.
- **Combined Stresses (fc)** are calculated using a simple algebraic sum of the bending stress for each direction and the axial stress. Therefore,  $fc(+y+z) = fa + fbz(+y) + fby(+z)$ ,  $fc(-y+z) = fa + fbz(-y) + fby(+z)$ ,  $fc(+y-z) = fa + fbz(+y) + fby(-z)$ , and  $fc(-y-z) = fa + fbz(-y) + fby(-z)$ . Note: The combined stresses shown in the analysis results can be conservative for some shapes (e.g. single angles, zees, spandrels, etc.). Since the design module has more information about the shape's cross-section than the analysis engine, the combined stresses used in the Generic Design Group are typically more accurate and less conservative than the combined stresses shown in the analysis results. [IES ShapeBuilder](#) is a convenient tool to verify the combined stresses for the shape in question.

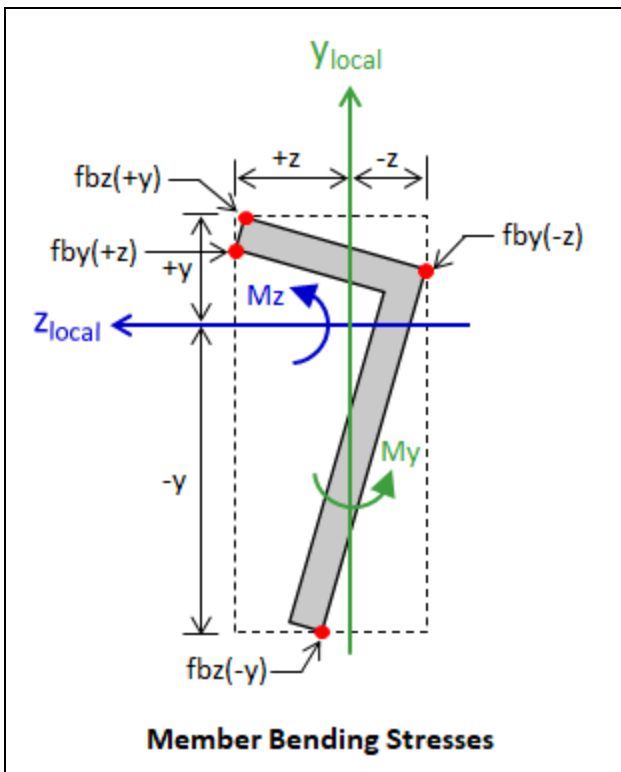

## Member Limitations

- Member elements are a 1D line element (they do not have dept, width, or thickness).
- Connections to members are made at the centerline of the member, since members are modeled using line elements.
- VisualAnalysis does not produce torsional stresses for members. Warping behavior of thin-walled open steel cross sections can be analyzed (with idealized boundary conditions) using the advanced [steel torsion design](#) process.
- VisualAnalysis does not perform 'buckling analysis', or 'plastic analysis' on member elements.

## 2.6 Plate Elements

Plate or shell elements are useful to model walls, slabs, roof systems or other flexible diaphragms either in bending or in shear. Mathematically plate elements are thin, 2D areas that may be represented as quadrilateral or triangular shapes (they

do not exhibit through-thickness stress variations like a 3D brick element). Since the finite element analysis method always produces approximate results it is crucial to refine the mesh until the results converge to minimize the error between the calculated solution and the actual solution. There is always a trade-off of performance vs. accuracy when using plate meshes. Generally an increased number of plates produces more accurate results, but requires more time to analyze and can increase the length of reports.

## Creating Plates

In VisualAnalysis, plates can be drawn manually or generated automatically using [Areas](#). Use the **Structure | Draw Plates** command to draw either triangular (3-nodes) or quadrilateral (4-nodes) plates on the Grid or to existing nodes in the Model View. To create a triangular plate element using this feature, double-click on the last point (when four points are selected, a quadrilateral plate is created automatically). Plates can also be created using the **Project Manager | Create | Add a Plate** feature based on three or four existing nodes in the model. To create plates using [Areas](#), draw an Area using the **Structure | Draw Areas** command and enable the Generate Plates feature in the Meshing section of the **Project Manager | Modify** tab for the selected Area. The Mesh Element Area in the Project Settings will control the size of elements in the mesh unless the Override Mesh Size feature is used to set the Element Area for a selected Area. Auto-generated plates require the advanced level of VisualAnalysis, but offer more flexibility, separation of loads from plates, and provide edge results that are easier to interpret. After plate elements are created, they can be selected to specify the thickness and material properties.

## Convert to Manual Plates

At times, it is convenient to automatically generate plates then convert the plates to manual plate elements using the **Structure | Convert to Plates** command. Converting an area mesh to regular plate elements disables auto-meshing for the area.

## Plate Element Formulation

A plate element will account for bending with transverse shear effects in thick plates and rotational drilling degrees of freedom. It is important to note that these formulations are not coupled during the initial analysis. The stiffness matrix for each formulation is computed separately in local coordinate space. The two formulations are assembled into a total 6 degree of freedom (DOF) global element matrix. Once assembled into the global element matrix, the element is combined into the total structural stiffness matrix. Membrane and bending coupling is achieved with the addition of geometric stiffness terms in the overall stiffness matrix. The additional stiffness terms result from membrane strains which are calculated during the initial analysis. Once the membrane strains are found the element stiffness is automatically updated to account for the extra stiffness terms resulting from membrane strains. The plates's bending behavior can be disabled using the **Project Manager | Modify** tab when a plate or area is selected. Both the membrane and bending formulations are based on triangular elements. When quadrilateral element is used, internally four triangles are used with a middle node which is removed through static condensation thus creating the quadrilateral.

### Bending: Thick-Thin Triangle (Xu)

The bending behavior of the plate element is based on the triangle formulation originally presented by Xu et. al. in 1992, which includes transverse shear effects.<sup>1</sup> Prior versions of VisualAnalysis and many finite element analysis packages use the discrete Kirchoff triangle (DKT) as their primary thin plate element. Although the DKT element is a reliable and widely used element for plate analysis, it cannot accurately model thick plates. The new element accounts for transverse shear effects present in structures that might contain areas with thick plates, such as footings or thick floor slabs.

### Membrane Formulation: Allman Triangle

Drilling degrees of freedom are included in the plate element, resulting in a 3-DOF per node plate element. Therefore, a moment can be applied perpendicular to the surface of the plate element at any of the three (triangle element) or four



nodes (quad element). Elementary membrane elements ignore drilling dofs in order to avoid membrane locking. Membrane locking in the new element was avoided by independently interpolating the drilling rotations over the element and introducing a penalty stiffness based on the shear modulus. The membrane element presented in VisualAnalysis is based on the early work of Allman.<sup>2</sup> The element is similar to the standard CST membrane element but includes an additional rotational degree of freedom at each node. VisualAnalysis uses 4-point symmetric integration using the points from Cook, which gives good results and matches the data from Allman's paper.<sup>3</sup> Drilling DOF in membrane elements are difficult as all elements exhibit "membrane locking" and zero-energy modes, these issues can become prominent in coarse meshes.

## Plate Thickness and Shapes

Both thin and thick plates can be modeled using VisualAnalysis as thick plates automatically include the effects of transverse shear deformations important for modeling foundations and footings. The quadrilateral element formulation can handle elements that are not square. While elements can be distorted without problems, the best results are obtained when the element aspect ratios are close to 1:1. Elements with larger aspect ratios (of 5:1 and higher) have been tested and have produced reasonable results.

## Plate Connections

By default, plate elements are rigidly connected to adjoining plate elements at the nodes in all directions. Select one or more plates to modify the releases at each node in the local coordinate system. Situations where numerous plate elements all connected to a single node should be avoided for efficiency reasons. This situation commonly happens at the center of a circular disk, with radially generated plate elements (consider adjusting the mesh near the center to alleviate the problem).

## Plate Local Coordinate System

Plate elements have a local coordinate systems with the origin located at the centroid of the plate. The local x-axis is parallel to and in the direction of a vector from the first node to the second. The local y-axis is perpendicular to the x-axis and in the plane of the plate. The right-hand rule is used to defined the local z-axis which is perpendicular to the plane of the plate. The local coordinate system for a rectangular plate element is shown in the figure below. The plate local axes are used when applying plate loads and for reporting local forces and stresses. When manually drawing multiple plate elements, it is helpful to be consistent and select the points in either a clockwise or counter clockwise direction so that the z-direction is the same for all plates. Use the **Project Manager | Filter** tab to show plate local coordinates. The **Structure | Reverse Local Axes** command can be used to flip the top and bottom of the selected plates.

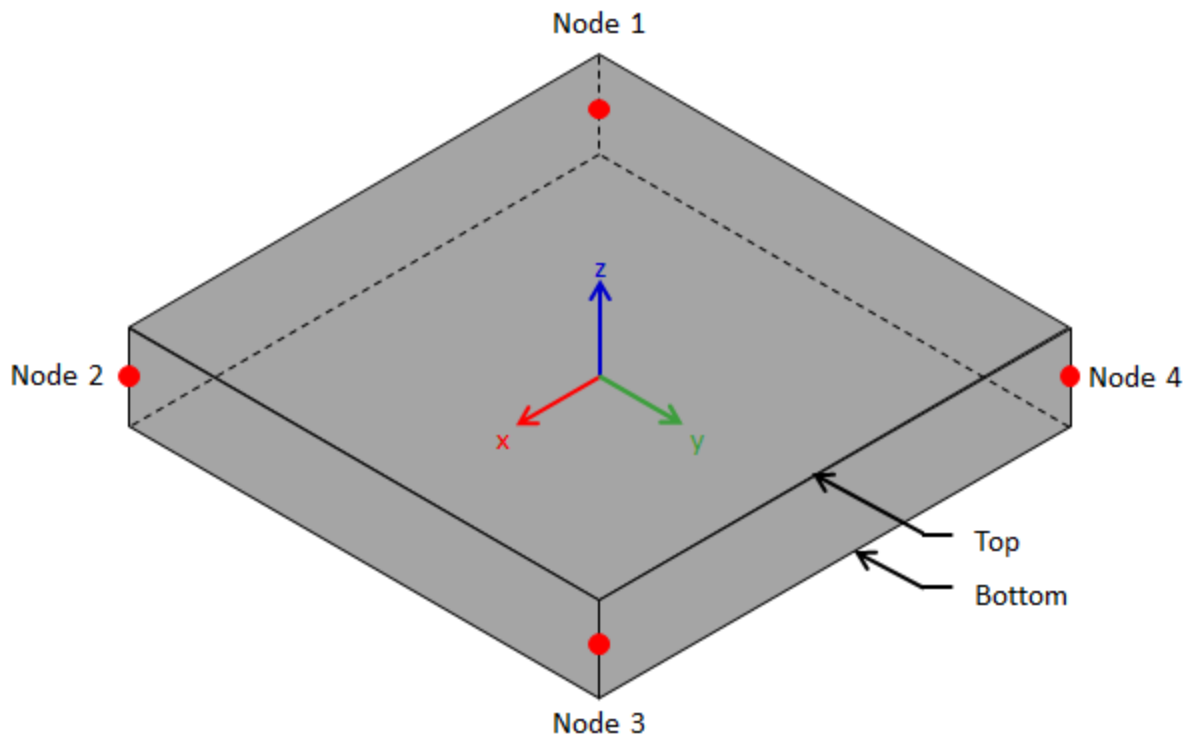

**Figure 1: Local Axes for Plate Finite Element**

## Mesh Refinement

It is the user's/engineer's responsibility to verify and validate the results obtained from VisualAnalysis. The finite element method is approximate and the accuracy of the solution depends on how fine the mesh is in the model (generally, a finer mesh produces more accurate results). A finite element mesh refers to the multiple plates that are used to model a single component (such as a slab or a wall). Mesh Refinement is the process of reanalyzing the model with successively finer and finer meshes and comparing the results between these different meshes. As the mesh is refined, the change in the solution becomes smaller and an asymptotic behavior of the solution starts to emerge as shown in the figure below. Eventually, the changes to the solution will be small enough that the user can consider the model to be converged, which is a judgment call. Plate elements in VisualAnalysis are meshed manually using the [Structure | Split Plates](#) command and the mesh refinement must be performed manually. Mesh refinement for plates generated from Areas (which requires the Advanced Level) is accomplished by reducing the Mesh Element Area in the [Project Manager | Modify | Project Settings](#). In general, a finer mesh should be used in areas where there are large changes in stresses and forces in the plates (such as at stress concentrations or at locations near concentrated loads).

### Mesh Refinement Procedure

1. Model the component (slab, wall, etc.) using a number of manually created plate elements or automatically generated plate elements from an Area.
2. Run the analysis and record the results.
3. Subdivide the plate element to create smaller elements (Split Plates or reduce the Mesh Element Area as discussed above).
4. Run the analysis and record the results.
5. Compare the results from Step 2 with the results from Step 3. If the difference in the analysis results is small and acceptable (a judgment call by the user), the mesh refinement process is complete. If the difference in the analysis results is large and unacceptable (a judgment call by the user), proceed to Step 3.

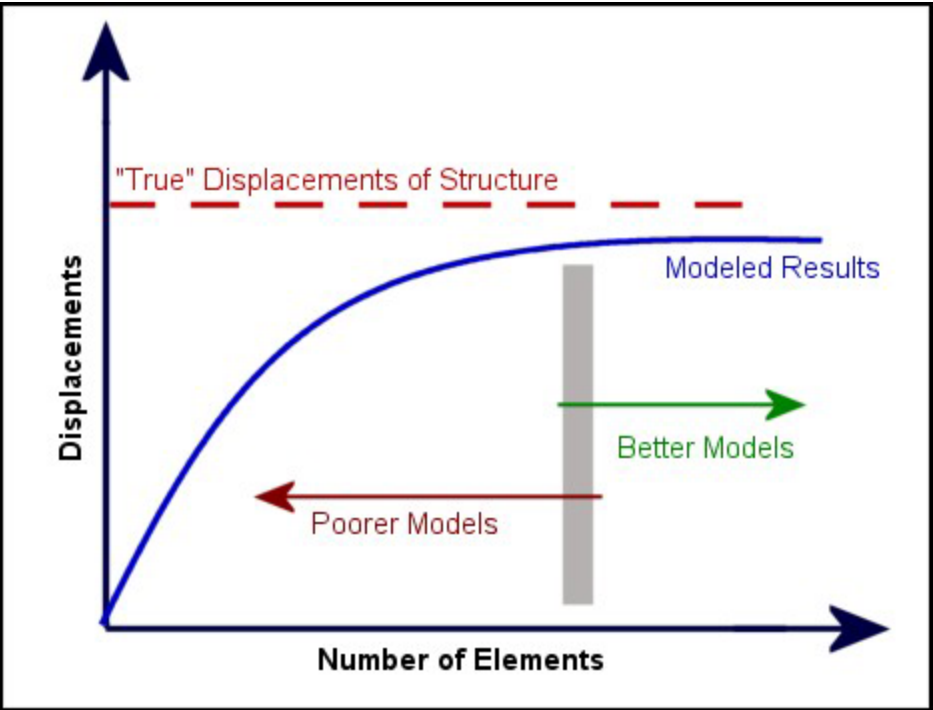
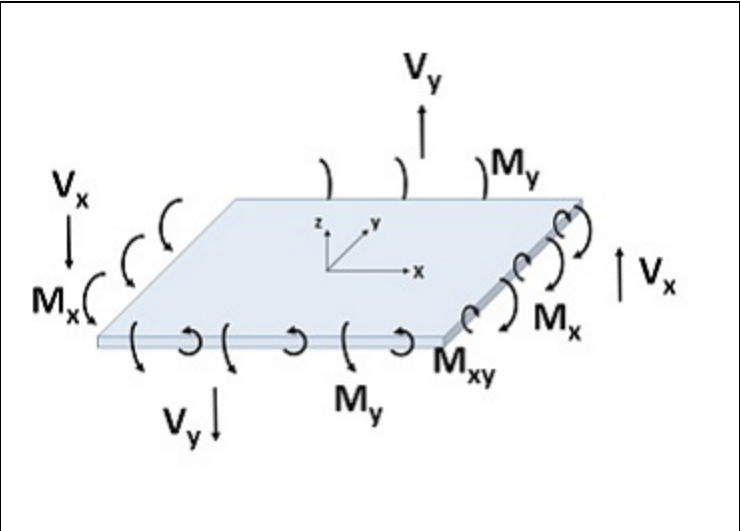

**Plate Results**

The moment and shear forces for out of plane bending and the in-plane normal or shear stresses can be reported for plate elements. Plate forces and moments are reported per unit length of plate. Moments have units of force\*length/length and shears have units of force/length. Plate membrane stresses may also be output relative to the global or local axes.

**Local Plate Results**

The sign convention for moments is that a positive moment produces tensile stresses on the +z local coordinate face of the element, as shown in the image below.



The image below shows the sign convention for tensile normal stresses which are positive.

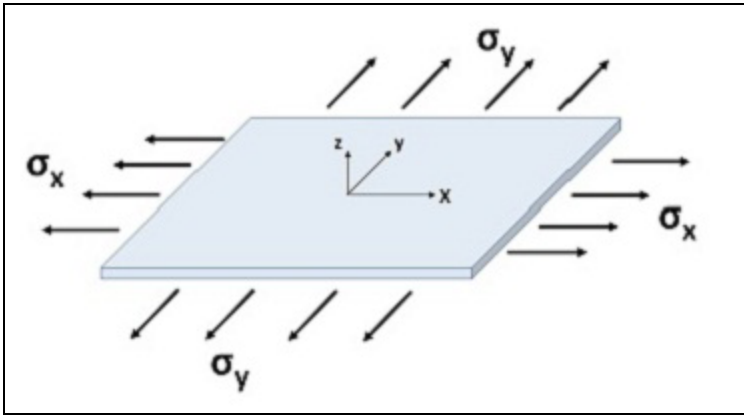

When plates experience bending, the stresses can be reported for the top and bottom faces. Stresses at the face are combined bending and membrane stresses. If plates are subject to bending stresses only, the neutral axis is at the mid-plane and therefore the normal stresses at this plane are zero.

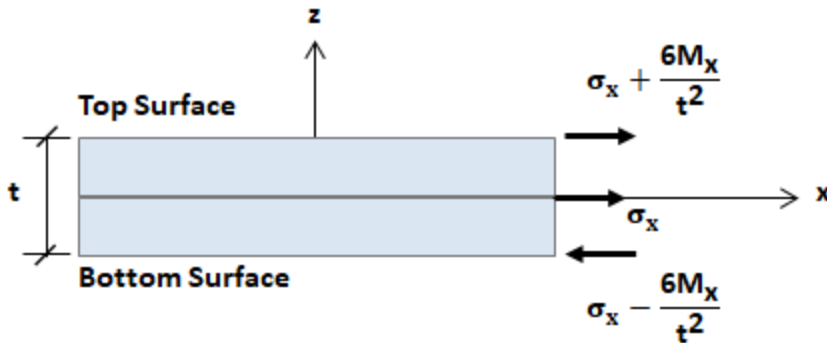

## Global Plate Results

Plate forces and stresses can be reported with respect to the global coordinate system. This simplifies interpretation of the results when the local axes of elements in a complex mesh are aligned. The global forces follow the right-hand-rule for sign convention where a positive  $M_X$  moment is at the global X edge of the plates and rotates about the global Z-axis. Some results may be zero after the transformation to the global directions, for example the global-Z moment for a mesh lying in the X-Y plane. Plate results can be seen graphically in [Result Views](#), or in various report tables.

## Von Mises Stress

The Von Mises stress,  $\sigma_v$ , can be reported for plate elements in VisualAnalysis and is defined as follows:

$$\sigma_v = \sqrt{((\sigma_1 - \sigma_2)^2 + (\sigma_2 - \sigma_3)^2 + (\sigma_3 - \sigma_1)^2)/2}$$

where

$\sigma_1$  = principal maximum stress.

$\sigma_2$  = principal minimum stress.

$\sigma_3$  = zero since a thin-plate element is used with no through-thickness stress.

## References

1. Xu, Zhongnian, ["A thick-thin triangular plate element"](#) International Journal for Numerical Methods in Engineering. v.

33, 963--973 (1992).

2. D. J. Allman. A compatible triangular element including vertex rotations for plane elasticity analysis. Computers & Structures, 19(1-2):1.8, (1984).
3. Robert D. Cook. Concepts and Applications of Finite Element Analysis. 4th Edition. Table 7.4-1. (2001) ISBN 978-0471356059

## 2.7 Areas

Areas are used to generate plate element meshes (to represent structural floors, walls, or roof systems) and/or to distribute loads to member or plate elements in the model. Applying loads to areas instead of applying them to members or plates can save time during the design process. For example, if a beam moves in the model, the load from the Area is adjusted automatically and eliminates the need to recalculate and modify the load on the beam. Areas alone have no mass, no stiffness, and offer no support in the model (Areas are not part of the finite element model that gets analyzed), but simply represent the floor, wall, or roof system in the model used primarily for loading the actual elements in the model. Therefore, member or plate elements should always be created corresponding to the Areas in the structural model.

### Creating Areas

#### Drawing Areas

Areas can be manually created by sketching them in the Model View using the **Structure | Draw Areas** command. **Drag** to define the first edge, **click** subsequent grid points or existing nodes to define subsequent edges. and **Double-click** the final point or **click** on the first point created to close the Area. Unlike Plate Elements which are defined by three or four nodes, Areas are defined by three or more vertices. Vertices can coincide with nodes in the model, but are not depended on nodes and do not move if the node is moved (there is no way to tie vertex locations to the node locations).

#### Generating Areas Automatically

Areas can be generated automatically using the **Structure | Generate Areas** command to generate exterior areas or all possible areas (both internal and external). Generated areas may not be perfect so they may need to be adjusted or unwanted areas may need to be removed. Areas can also generated based on the extents of the selected model items (nodes, elements, etc.) using the **Structure | Areas from Selected** command.

#### Convert to Manual Plates

At times, it is convenient to automatically generate plates then convert the plates to manual plate elements using the **Structure | Convert to Plates** command. Converting an area mesh to regular plate elements disables auto-meshing for the area.

### Area Local Coordinate System

Areas have a local coordinate systems with the origin located at the centroid area. The local x-axis is parallel to and in the direction of a vector from the first vertex to the second. The local y-axis is perpendicular to the x-axis and in the plane of the area. The right-hand rule is used to defined the local z-axis which is perpendicular to the plane of the area. The local coordinate system for a rectangular area is shown in the figure below. The local axes of the area are used when applying plate loads. When drawing multiple areas, it is helpful to be consistent and select the vertices in either a clockwise or counter clockwise direction so that the z-direction is the same for all areas. The **Structure | Reverse Local Axes** command can be used to flip the top and bottom of the selected areas.

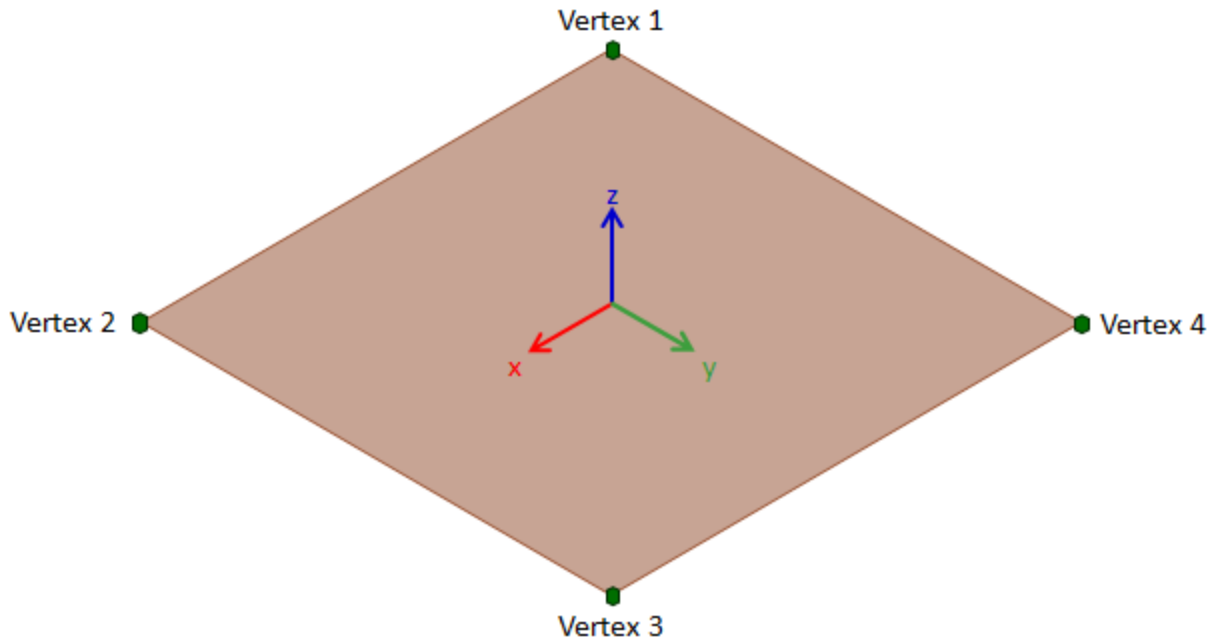

**Figure 1: Local Axes for Areas**

## Modifying Areas

Since Areas are defined by vertices, not nodes, they do not automatically "track" movements or changes in the model. Use the [Project Manager | Model Filter](#) tab to display Area Vertices in the model. Select Vertices in the Model View or in the Find Tool to adjust their location or to move them in the [Project Manager | Modify](#) tab. Editing Vertices can cause the size, shape, and/or location of the Area to change. Select an area and use the [Structure | Move](#) or [Structure | Rotate](#) commands to adjust the location or orientation of the Area in the model, respectively.

## Holes & Corridors

Holes are areas embedded within other areas that do not receive loads. Corridors are embedded areas that can receive higher loads, such as for IBC / ASCE 7 load requirements. Embedded areas are defined by sketching an area within an existing area. After drawing an embedded area, specify its type in the [Project Manager | Modify](#) tab.

## Span Data

For Areas, the Span Type can be set to One Way or Two Way to specify how the loads are transferred to the in-plane supporting members. One Way spans are typical for joist systems where closely spaced parallel members carry loads to girders. Two Way spans are typical when the distance between beams and girders is similar causing the load to be transferred both ways. When plates are loaded with areas, this setting has no effect.

## Generate Meshed Plates

### Requires: Advanced Level

Since Areas alone have no stiffness, to model the stiffness of a floor, wall, or roof [Plate Elements](#) can be generated from Areas using the Generate Plates Feature in the [Project Manager | Modify](#) tab. Existing nodes and members within the plane of the area are incorporated into the generated plate mesh. Areas that contain manual plates cannot be meshed.

- **Membrane Only** - Specify if meshed plates carry only in-plane forces or stresses with no out-of-plane bending.

- **Mesh Thickness** - Specify the thickness used for the plate elements generated during meshing of the area.
- **Mesh Material** - Specify the material used for the plate elements generated during meshing of the area.
- **Create Soil Springs** - Specify if springs should be placed beneath the meshed nodes to represent soil springs.
- **Override Mesh Size** - Specify if the Mesh Element Area from the Project Settings should be used or if it should be overridden for the selected area. Strategic generation of plates can improve the accuracy and performance of the model. See [Mesh Refinement](#) information for more details about convergence.
- **Advanced Mesher Options** - The mesh settings on specific areas can set to further refine plate mesh generation. These settings are typically used to solve meshing geometry problems or to create better 'transition' zones between areas of very large and very small plate elements. The following criteria can be changed and is often best used in a trial & error to see how the mesh changes.
  - **Triangulation Method** - The algorithm method used to triangulate the area into a plate mesh.
  - **Smooth Mesh** - Should the auto-mesher smooth the plate mesh? If set to 'Yes', the auto-mesher will make a second pass on the initial mesh to refine element sizes and angles. Note that for large plate meshes, this may affect performance.
  - **Min Element Angle** - The minimum angle (approximate) for an individual triangular plate element within the mesh.
  - **Override Max Element Angle** - Should the maximum triangular element angle be overridden with a user supplied value?
  - **Override Segment Constraint** - Override the spacing of point constraints along lines in the mesh (e.g. members or area edges).

## Area Side Support

The sides of meshed Areas can be supported similar to nodes. Side supports are defined by selecting one of the Area sides in the Model View and selecting from the available constraints under Support in the **Project Manager | Modify** tab. Side supports simply support all meshed nodes along the boundary and are automatically updated if the area is remeshed. If the Auto Generate Sides? feature is disabled, side Area Sides can be created using the **Structure | Add Area Sides** command.

## Area Loads

Select an Area and use the **Loading | Apply Area Load** command to apply a uniform load normal to the area. After an Area Load has been created, it can be selected and the following parameters can be modified:

- **Type** - Specify the type of load (uniform or linear).
- **ApplyTo** - Specify what the load will be applied to (members or plates).
- **Direction** - Specify the direction of the applied load.
- **Magnitude** - Specify the magnitude of the Uniform pressure and select from a predefined ASCE 7 Load or define the parameters of the Linear area load.

In addition to being loaded in the normal direction, load can be applied to the sides of an Area using the **Loading | Apply Area Side** Load command. Area Side Loads consist of forces, moments, settlements, and rotations can be applied in the global X, Y, or Z directions.

## Area Results

Area Results are only available for areas that have Generated Plates. Area Side Results are obtained from the plate forces applied to nodes along the edge and are useful for designing shear walls and diaphragms since total or average results are more convenient to work with than individual plate element results. Results are available as the Average, Detailed, or Total forces calculated for each Area side and the In-Plane Shear, In-Plane Axial, Flexural Shear, Flexural Moment, and Overturning Moment are reported. The sign convention depends on the direction that Areas were drawn. The direction for

the sides can be shown by enabling the Side Direction option in the **Project Manager | Model Filter** tab.

## 2.8 Soil-Spring Generator

The Soil Spring Generator is a convenient way to create soil-support under manually meshed [Plate Elements](#) or [Auto-Meshed Areas](#). The generator will create compression-only springs with the stiffness based on the area of the plate elements and soil subgrade modulus.

### Generating Soil Springs for Plates

Select the desired plate(s) and click the **Structure | Generate Soil Springs** command to create soil springs. Note: the plate elements do not need to be in the same plane as the spring supports are created perpendicular to each selected plate. In the soil Spring Generator dialog box, specify the subgrade modulus and the soil contact face. If the plates already have springs at the nodes, the Superposition Method (combine stiffness on existing springs or replace existing springs) and the Angle Tolerance will need to be set. The spring stiffness is calculated using the following formula:  $K_{\text{Spring}} = \text{Subgrade Modulus} * \text{Plate Surface Area}$ . The total spring stiffness,  $K_{\text{Spring}}$ , for the plate is distributed to the three or four plate element nodes based on tributary area. Note: Generated Soil Springs do not update automatically if the dimensions of a plate are changed.

### Generating Soil Springs for Areas

Select the desired Area(s) and ensure that the Generate Plates feature is enabled in the **Project Manager | Modify** tab. Then, enable the Create Soil Springs option, specify the Subgrade Modulus, and adjust the Soil On Bottom parameter to define on which side (top or bottom) the springs should be created. The stiffness of each spring will be automatically adjusted if the area is modified or if the mesh is adjusted.

## 2.9 Cable Elements

### Requires: Advanced Level

Cable elements sag and are unique due to their initial displacement. Cable elements only carry axial loads (they do not carry shear or bending moments). Cables tend to exhibit highly geometrical nonlinear behavior and are highly sensitive to their initial conditions. Cables have a number of uses including suspension and cable stayed bridges, guyed poles and towers.

### Creating and Modifying Cables

Cables can be created using the **Structure | Draw Cables** command to draw members on a Grid or to existing nodes in the model. After cables are created, they can be selected to specify the Catenary Length, Diameter, Material, and Connecting nodes in the **Project Manager | Modify** tab. If the specified Catenary Length is longer than the Straight Length, a value for the Initial Sag for the cable will be displayed. If the specified Catenary Length is shorter than the Straight Length, the cable will be prestressed and the prestressing force can be calculated using Hooke's law. Cables can be Split, Copied, Moved, or Rotated using the commands in the Structure ribbon.

### Loading Cables

Cables can only be loaded with concentrated nodal loads. Therefore, cables must be split before a concentrated load is to be applied along the span. Cable elements only carry axial loads (they do not carry shear or bending moments). Note: the Y global axis is always considered the vertical axis for cables which is important as it defines the cable's sag.



## Splitting Cables

Cables are split using the **Structure | Split Cable** command. There are three options for splitting cables: equal catenary segments, equal horizontal projections, and custom catenary segments. For the equal catenary segments and equal horizontal projections options, simply specify the number of segments. For the custom catenary segments option, specify the number of segments and the length of each segment (except for the last segment) as measured along the cable. The length of the last segment will automatically be calculated as the remaining portion of the cable's length. It is recommended that cables be split after the geometry is fully defined. While VisualAnalysis does allow segments of a cable to be edited after it is split, there is no "knowledge" of its global identity. In other words, a cable segment could sag within the overall cable as shown below (this does not make physical sense and should be avoided).

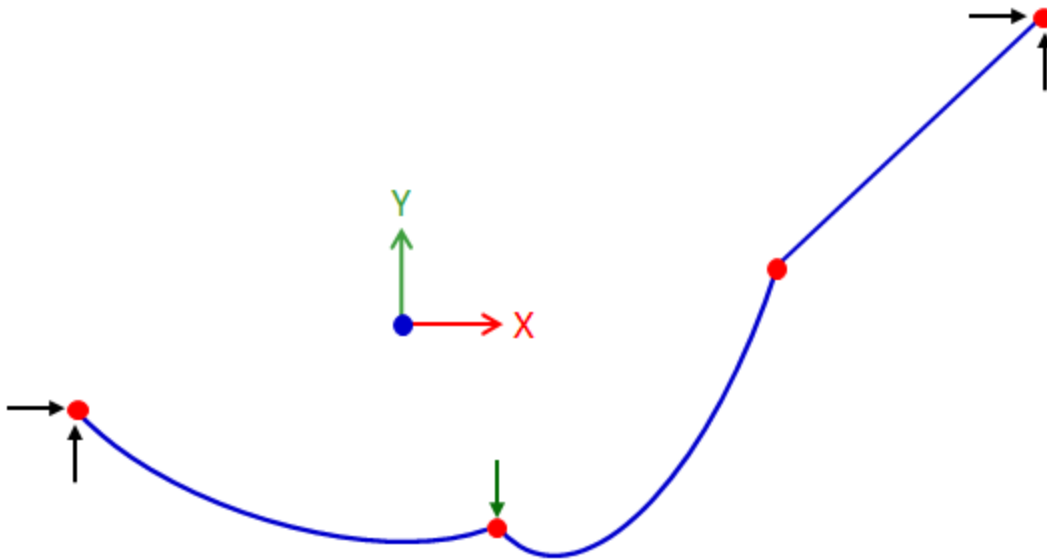

## Convergence During Analysis

Since cables are geometrically nonlinear, the cable element stiffness is a function of the tension in the element, and the solution method is iterative, it is possible to apply too large a load to a cable element and not have the analysis converge. In this case, simply reduce the load and VisualAnalysis will automatically reanalyze. When experiencing convergence issues, consider exploring the Advanced Analysis Project Settings in the **Project Manager | Modify** tab. Specifically, the Return Unconverged Results feature can be used to display partially converged results within the analysis results. If an analysis is unable to converge, it is possible that a partial solution (i.e. reduced loads) is able to converge, for which results can be displayed. Note: mode shapes cannot be obtained for cables (or for other nonlinear problems) in VisualAnalysis.

## Results & Reports

The axial force, axial stress, and displacements can be displayed for cables in the Results View. Select one or more cables to see the extreme results in the **Project Manager | Results** tab or select the Result Type on the **Project Manager | Results Filter** tab to be displayed graphically. The analysis results for cables can be reported by inserting the Cable Results table from the **Project Manager | Add Tables** tab. Also, the Cables table can be reported to include the parameters (diameter, material, straight length, catenary length, etc.) for each cable in the model.

## Strange Deflected Cable Shapes?

An upward arc type displacement is sometimes seen in long cables that have been split into several sub cables when large displacement magnifiers are used in the **Project Manager | Results Filter** tab. Set the **Amplification Type** to Absolute and the **Absolute Amplification** to a value of one to see the true deflected shape.

## Cable Limitations

- Cables in VisualAnalysis always assume that the global Y-axis is the vertical direction.
- Cable elements require self weight to function properly, therefore disabling or factoring self-weight will not have any impact on the cable elements, their actual weight is included in each service case or combination that is analyzed.
- Most manufactured cables are wire-rope assemblies that will untwist and stretch differently than a solid material. VisualAnalysis does not take this behavior into account.

## References

1. Huu-Tai Thai, Seung-Eock Kim. Nonlinear Static and Dynamic Analysis of Cable Structures. Finite Elements in Analysis and Design. 74, 237-246, (2011).
2. Raid Karoumi. Some Modeling Aspects in the Nonlinear Finite Element Analysis of Cable Supported Bridges. Computers & Structures 71, 397-412, (1999).

## 2.10 Semi-Rigid Connections

### Requires: Advanced Level

Semi-rigid connection behavior can be specified for the strong bending ( $R_z$ ) and/or weak bending ( $R_y$ ) at the ends of a member elements. The other degrees of freedom ( $D_x$ ,  $D_y$ ,  $D_z$ ,  $R_x$ ) are always controlled by member end releases and are defined as either rigid or released. While steel connections are typically idealized as Rigid (Fully Restrained Moment Connections) or Simple (Simple Shear Connections) they actually behave somewhere in between these two extremes (i.e. rigid connections have some flexibility and simple connections provide some moment restraint). Also, some connections are semi rigid (e.g. for a partially restrained moment connection). In either case, Semi-Rigid connections can be used to model these connections in VisualAnalysis.

### Using Semi-Rigid Connections

Semi-Rigid connections are specified by selecting a member and setting the parameters in the Semi Rigid section of the **Project Manager | Modify** tab. Three different models can be used for  $R_z$  and  $R_y$  of Node1 and Node 2 of a member in VisualAnalysis: Constant, Bilinear, and Power Model. The Constant model is defined by the slope of the moment-rotation curve ( $K$ ). The Bilinear model is defined by the initial slope ( $K_1$ ), the final slope ( $K_2$ ), and the transition moment (Bi-Moment). The Power Model is defined by the shape factor for the fit of the curve ( $n$ ), the initial rigidity of the connection or slope of the first linear portion of the moment-rotation curve (Power Stiff.), and the ultimate moment capacity (Power Moment) for the connection that will be asymptotically approached. For the Power Model, the larger the value of  $n$ , the steeper the curve and the closer it "fits" the two tangents.

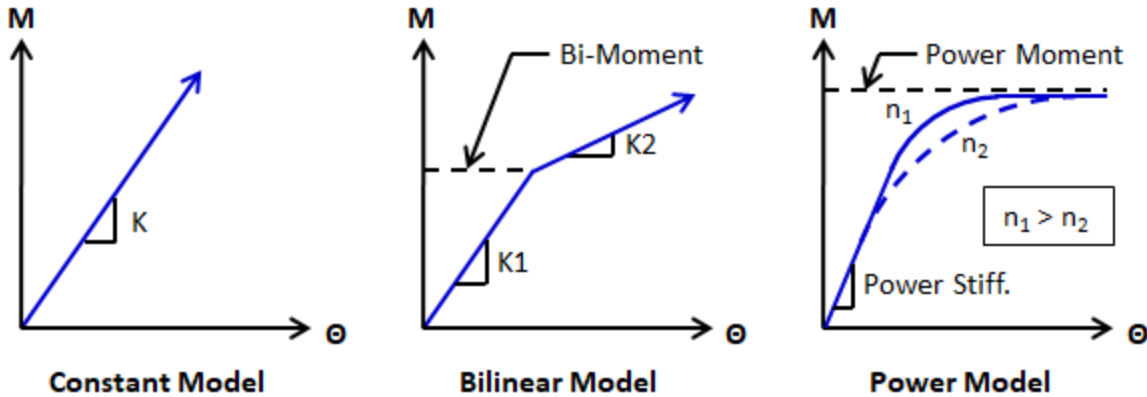

### What Rigidity Value to Use?

There are a number of references that address semi-rigid behavior. For example, *Stability Design of Semi-Rigid Frames* gives formulas and tables for specific connections and their associated rigidity values.<sup>1</sup> Also, *Modeling of Connections in the Analysis of Thin-Walled Space Frames* is a useful reference.<sup>2</sup>

### Modeling Plastic Hinges

Both the Bilinear and Power Model can be used to model plastic hinge behavior. If the plastic hinge does not occur at the end of a member, the member will need to be split so that a semi-rigid connection can be specified at the hinge location. In some situations, manual iteration might be required to determine hinge locations and split and insert the hinges. Note: The hinge locations could be different for each load case or combination.

### Nonlinear Analysis

The rigidity model selected for semi-rigid behavior of the connection will designate whether a linear or a [nonlinear analysis](#) is performed. The Constant model uses a linear analysis while the Bilinear and Power Models both require a nonlinear analysis.

### Reporting Semi-Rigid Connections

For each specified semi-rigid connection the report specifies:

- The member and node where the connection is located.
- The Semi-Rigid connection model type (Constant, Bilinear, or Power Model).
- The degree of freedom specified as semi-rigid (Ry or Rz).
- The stiffness or stiffness for the model.
- The moment for the Bilinear or Power Model.
- The power for the Power Model.

### References

1. W.F. Chen, Yoshiaki Goto, and J.Y. Richard Liew. *Stability Design of Semi-Rigid Frames*. John Wiley & Sons, Inc. (1996). ISBN 0-471-07670-8.
2. H. Shakourzadeh, Y.Q. Guo, and J.L. Batoz. *Modeling of Connections in the Analyses of Thin-Walled Space Frames*. Computers and Structures 71, 423-433, (1999).

## 2.11 Limitations

VisualAnalysis has been designed to solve problems that are commonly faced by engineers with input from numerous customers. VisualAnalysis has the following limitations:

- Not useful for large displacements (geometric nonlinearity, except for the cable element)
- No automatic plastic analysis (users can manually iterate with increasing loads and insert end releases to simulate plastic behavior)
- Not a turn-key system for building or truss design (the user decides the layout and must pick initial member sizes)
- No automatic total structural optimization
- Does not run inside or integrated with AutoCAD (or any other CAD tool)
- No internal pipe pressures
- No orthotropic or anisotropic materials (linear, elastic isotropic only)
- No solid elements, or brick elements
- No curved beams (can be simulate curved beams with chords)
- No staged loading or active or inactive elements acting per load case
- No pre-stressed or post-tensioned concrete design
- No AASHTO bridge design

## 3 Load

### 3.1 How To

#### 3.1.1 Working With Loads

##### Select the Active Load Case

Use the Command Bar to select which load case is displayed and active in a Model View, or which Result Case for a Design View. A Model View shows one Service Load Case at a time. Result Views, Member Graphs and Plate Graphs will show any result case, which may be results from a Service Load Case, an Equation Load Combination, Factored Load Combination, Mode Shape, or Response Load Case. A single load case or combination may create multiple result cases (1st-Order, 2nd-Order, Envelope, Time Step, etc.)

Design Views do not show any one load case but rather results for all Strength and Serviceability load cases as defined on the Load Combinations tab of Load Case Manager.

##### Apply Loads

The easiest way to apply loads is to select the appropriate load case first, then select the items to be loaded (e.g., some members), then **Right-Click** in the Model View to find the **Apply Member Loads** command. [Static, physical loads](#) (forces, moments, etc) may be applied to Areas, Members, Plates and Nodes and Rigid Diaphragms. Other types of "loads" available include settlements (applied as nodal loads), seismic loads (applied as a design spectrum in a Dynamic Response load case or as a forcing function in a Dynamic Time History load case), or "inertial mass" (associated with a node directly).

##### Find Loads

Loads may be filtered in a Model View and selected individually or in groups just like other model objects. Sometimes it is difficult to locate loads visually. Use the Find Tool to view loads.

When using the Find tool with loads, you will need to use the load case selector that is in the Find tool rather than the one in the Status Bar.

The Find tool lists may be sorted on any column (**Click** the column title) and the columns may be resized (**Drag** the divider between column titles). See the Essentials chapter for more information about the Find tool.

##### Select Loads

Select loads just like other model objects. Use the **Filter** tab in Project Manager to make them visible in the Model View. Use the mouse to **Click** on the load to select it. Loads may be in different directions, so you may need to hunt for where to click in order to select it. If you turn off the nodes, members, and plates, it makes it easier sometimes.

See the Essentials chapter for more information about selecting.

##### Edit Loads

Loads are edited just like other model objects. Select a load, or multiple loads of the same type and use the **Modify** tab in Project Manager. To quickly edit a load individually simply double click it.

##### Delete Loads

Select loads in a Model View or Find tool and then delete them with **Home | Delete** or by pressing the **Del** key on your

keyboard.

## Copy Loads to Another Load Case

Select the loads and choose **Structure | Generate Copies** to open the Generate Copies Wizard. Choose Copy to Other Load Cases and enter a scale factor if necessary, then press **Next**. Select the destination load case(s) in the list and press **Finish**.

You can also use this faster procedure to copy loads to another load case. Select the loads, then use **Home | Copy**. Now switch the active load case in the Status Bar and choose **Home | Paste Load from Other Case**.

During the copy operation you will have an opportunity to scale the load magnitudes in a linear ( $Ax + B$ ) fashion.

## Copy Loads to Other Objects

Select the loads and choose **Home | Copy**. Now select the destination objects in the Model View. Be careful to not change the active load case. Finally, choose **Home | Paste Special** to open the Generate Copies Wizard. Choose **Copy to Other Nodes or Elements** and enter a scale factor if necessary. Press **Next** and check the list of objects to make sure the correct nodes or elements are selected and then press **Finish**.

In some cases, VisualAnalysis will recognize what you are doing after you have done the copy and selected other objects. In this case, a special menu item will appear similar to this: **Home | Paste Load on Selected Members**. When this command appears, you will not see the Generate Copies Wizard, the loads will simply be copied.

After the copy operation you can scale the load magnitudes in a linear ( $Ax + B$ ) fashion, by selecting them and choosing the **Loading | Adjust Selected Loads** command.

## Factor the Loads

Building codes often require that you factor your loads. Normally these factors are applied through building code combinations that are automatically generated by VisualAnalysis .

You may manually factor loads as you create them in a Service Load Case, but this is not very flexible. VisualAnalysis also provides custom Equation and Factored Load Combinations to combine and factor loads. The **Load** menu provides commands to generate factored combinations.

Finally, after loads are created you can apply manual factors to them by selecting them and using the **Loading | Scale Loads** command.

## Make Patterned Loads

VisualAnalysis provides limited support for creating patterned load combinations with live loads. Each service load case based on live loads may include an optional pattern number 1, 2, 3, etc. When load combinations are generated with the building-code load combination system, only cases with matching pattern numbers are combined together.

For any other kind of patterned loading situations you can create service cases manually to contain loads that are excluded from the automatically generated building code combinations and then manually create custom load combinations to combine the loads in any way you choose.

## Display Factored Loads Graphically

To see your factored loads graphically, follow these steps:

- First, load and support your model using the **Model View**.
- Use the **Load Case Manager** to create Load Combinations to run during the analysis.
- Switch to the **Result View**, and from the **Project Manager | Result Filter**, set the Overlay Undisplaced option to

'Shown'. (Note: also make sure you have the Model Filter set to show Loads)

- Finally, use the **Ribbon | Home Tab | Result Case** dropdown to select a Load Combination. The factored loads will be shown graphically in the Result View.

## Find the Total Load in a Load Case

To find the sum total of loads in a load case you will need to analyze to get results. Look on the **Result** tab of Project Manager, available when a Result View is active, to see the Static Check. The Static Check balances the total load in each direction with the total reaction force in each direction.

### 3.1.2 Example: Unbalanced Snow Loads

When analyzing snow loads, ASCE 7 states that balanced and unbalanced snow loads shall be analyzed separately. Below is an example outlining the use of [Patterned Service Cases](#) for separating the balanced and unbalanced loading conditions within VisualAnalysis.

#### Given

DEAD LOAD	= 15 PSF
SLOPED ROOF SNOW LOAD, $P_s$	= 60 PSF
SNOW DENSITY	= 25.2 PCF
DRIFT HEIGHT, $h_d$	= 2.4 FT

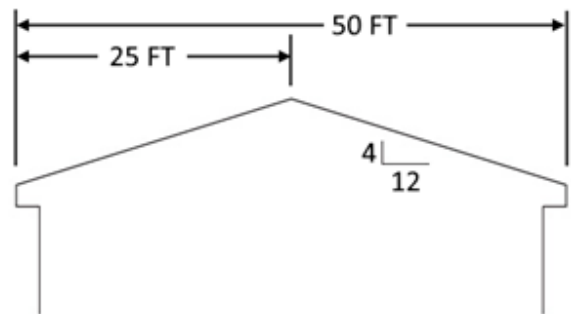

#### Find

Determine analysis results for the roof rafters using ASCE 7 ASD load combinations for balanced and unbalanced snow loading conditions. Assume rafters are spaced at 24-inches o.c.

#### Solution

##### Step 1: Determine member loads

# VisualAnalysis 19 User's Guide

## DEAD LOAD

UNIFORM  
DL = 15 PSF \* 2 FT  
= **30 PLF**

## SNOW LOAD

BALANCED  
SL = 60 PSF \* 2 FT  
= **120 PLF**

UNBALANCED - WINDWARD  
SL = 0.3 \* P<sub>s</sub> \* 2 FT  
= **36 PLF**

UNBALANCED - LEEWARD  
SL1 = P<sub>s</sub> \* 2 FT  
= **120 PLF**  
SL2 = (h<sub>d</sub> \* γ) / √S \* 2 FT  
= **69.8 PLF**

$$\frac{8}{3} * h_d * \sqrt{S} = 11.0 \text{ FT}$$

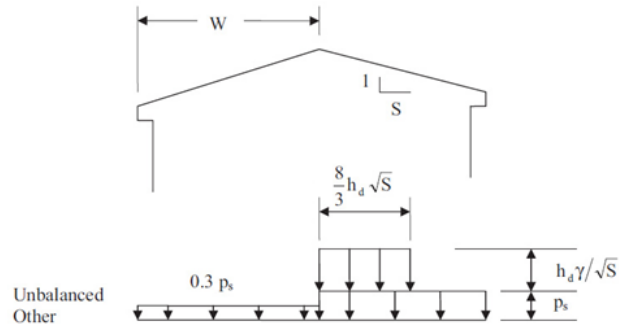
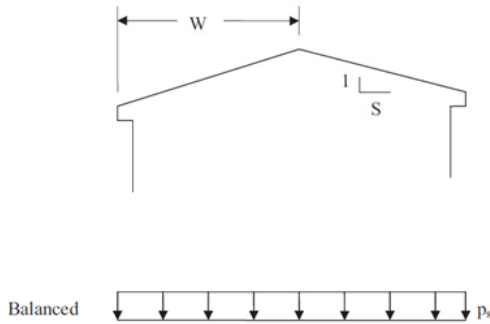

## Step 2: Create Patterned Service Cases

Create two or more new service cases through the Load Case Manager. The first Service Case, named S-Bal, has a Snow load source and a Pattern ID = 1. The second service case, named S-Unbal, has a Snow load source and a Pattern ID = 2. This will allow loads placed in these service cases to be automatically separated in the Building Code combinations and will be analyzed separately.



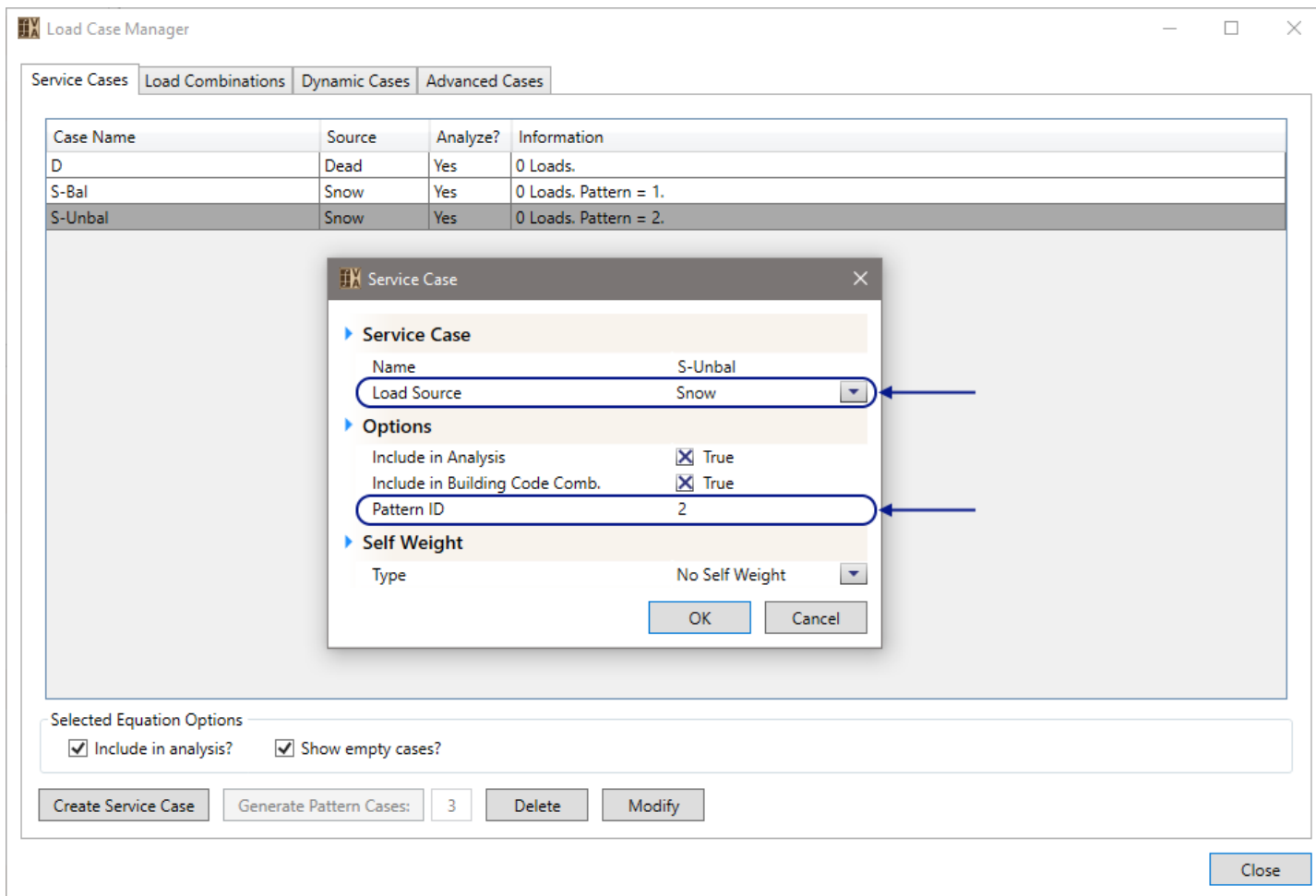

### Step 3: Model and Apply Loads

A simple two-member model is created, and boundary conditions applied. The dead loads are applied to the model in the 'D' Service Case. Balanced snow loads are applied in the 'S-Bal' Service Case. Unbalanced snow loads are applied in the 'S-Unbal' Service Case.

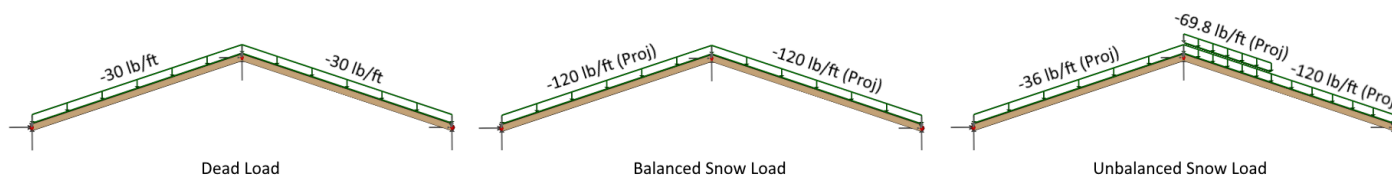

### Step 4: Select Load Combinations through the Load Case Manager

Within the [Load Case Manager | Load Combinations](#) tab, select an ASCE 7 ASD building code to auto generate load combinations. Note that equations using 'S-Bal' and 'S-Unbal' are automatically separated into combinations without the other present.

The screenshot shows the 'Load Case Manager' window with the 'Load Combinations' tab selected. On the left, a list of building codes is shown, with 'ASCE 7-16 ASD' highlighted. The main table displays the following data:

Comb. Name	Type	Effective Equation	LL Reduction	Design Category	Analyze	Construction
1. D	ASCE 7-16 ASD	D	None	Allowable (ASD)	Yes	No
3. D+S(#1)	ASCE 7-16 ASD	D + S-Bal	None	Allowable (ASD)	Yes	No
3. D+S(#2)	ASCE 7-16 ASD	D + S-Unbal	None	Allowable (ASD)	Yes	No
4. D+0.75(L+S)(#1)	ASCE 7-16 ASD	D + 0.75S-Bal	None	Allowable (ASD)	Yes	No
4. D+0.75(L+S)(#2)	ASCE 7-16 ASD	D + 0.75S-Unbal	None	Allowable (ASD)	Yes	No
7. 0.6D+0.6W	ASCE 7-16 ASD	0.6D	None	Allowable (ASD)	Yes	No

An arrow points to the 'Effective Equation' column, with the text: "Note the automatic separation of the Snow Load service cases due to the Pattern Loading".

Below the table, there are controls for 'Selected Equation Options', including a checkbox for 'Include in analysis?', a 'Design category' dropdown, and a 'Convert to Custom' button. At the bottom, there are buttons for 'Import From Clipboard', 'Create Factored Combination...', 'Modify...', 'Delete', and 'Close'. A status bar at the bottom right indicates '6 Factored Combinations'.

## Step 5: Review Analysis Results

From the Results View tab, graphically review the analysis results by changing the Result Case drop down from the Ribbon. A Summary of the Result Case is available in the Project Manager when nothing is selected. The individual member results can be viewed in the Project Manager by graphically selecting the member.

## Step 6: Generate a Text Report

A text report displaying the analysis results can be generated using the Report View tab. The tables below summarize the extreme strong axis moment within both members.

## Result Cases

Name	ID	Effective Equation	Design Checks
3. D+S(#1)	2	D + S-Bal ←	Allowable (ASD)
3. D+S(#2)	3	D + S-Unbal ←	Allowable (ASD)
4. D+0.75(L+S)(#1)	4	D + 0.75S-Bal	Allowable (ASD)
4. D+0.75(L+S)(#2)	5	D + 0.75S-Unbal	Allowable (ASD)

## Member Forces, Detailed

(extreme rows: max/min when opposite sign, by object)

Member	Result Case	Offset ft	Mz K-ft
M1	3. D+S(#1) ←	13.18	<b>11.85</b>
M1	3. D+S(#2)	13.18	<b>5.28</b>
M1	4. D+0.75(L+S)(#1)	13.18	<b>9.50</b>
M1	4. D+0.75(L+S)(#2)	13.18	<b>4.58</b>
M2	3. D+S(#1)	13.18	<b>11.85</b>
M2	3. D+S(#2) ←	13.18	<b>13.75</b>
M2	4. D+0.75(L+S)(#1)	13.18	<b>9.50</b>
M2	4. D+0.75(L+S)(#2)	13.18	<b>10.93</b>

## 3.2 Loading Topics

### Introduction

After a model has been created for the structure, the next step is to apply loads to the system. A structure can experience loads from many sources: self weight, external loads (live load, snow load, wind load, earthquake load, etc.), temperature changes, settlements, etc. While VisualAnalysis does not automatically generate the required loads, it does provide tools to make load application easy.

### Self-weight

By default, the self-weight of the model (weight of members and plates) is automatically included in the Dead Load Service Case. Any Service Load Case with can include the self-weight of the structure by setting the Service Case in the ribbon and clicking the **Home | Edit Load Case** command. The self-weight can be applied in the vertical axis (defined in the **Project Manager | Modify** tab) or applied in any direction and scaled as needed. If self-weight is included in more than one load case, careful attention to load combinations needs to be taken to ensure that the self-weight is not being duplicated. Self-weight is automatically factored in the load combinations.

### Loading Topics

- [Working with Loads](#)
- [Nodal Loads](#)
- [Member Loads](#)
- [Plate Loads](#)
- [Area Loads](#)
- [Load Cases](#)

### Advanced Loading

- [Dynamic Loads](#)

- [Moving Loads](#)
- [Time History Loads](#)
- [Patterned Load Cases](#)
- [Live Load Reduction](#)
- [Load Helper](#)

## 3.3 Nodal Loads

Nodal loads are applied to selected nodes using the **Loading | Apply Nodal Loads** command or the **Ctrl+1** hotkey. In the Add Node Load(s) dialog box, the Load Case, Load Type, and Magnitude are specified.

### Nodal Load Type

Forces, moments, settlements, and rotations can be applied to nodes in the model. All nodal loads are applied in the global coordinate system {X, Y, or Z}. Since VisualAnalysis does not allow loads to be applied at an angle, skewed loads are applied by breaking the loads into the appropriate components in the global coordinate system. While forces and moment should be applied to nodes that are free in the direction of the applied load, settlements and rotations can only be applied to nodes that are fixed in the direction of the applied settlement or rotation.

### Nodal Mass

Lumped mass on a Node can be specified in the **Project Manager | Modify** tab, which is only used for inertia during dynamic analysis. This mass is not used for self-weight or static analysis.

## 3.4 Member Loads

Member loads are applied to selected members using the **Loading | Apply Member Loads** command or the **Ctrl+2** hotkey. In the Add Member Load(s) dialog box, the Load Case, Load Type, Magnitude and Location are specified.

### Load Types

The following Load Types are available for members:

- **Single Point** - Concentrated force or moment
- **Evenly Spaced Points** - Concentrated forces or moments equally spaced
- **Fractional Span Points** - Concentrated forces or moments applied at a distance equal to a fraction of the span
- **Uniform** - Uniformly distributed force or moment
- **Linear** - Linearly distributed force or moment
- **Temp. Change** - Change in member's temperature which influences the member's axial forces and/or displacements.
- **Thermal Gradient** - Change in member's temperature gradient which influences the member's bending moments and/or displacements

### Load Directions

Concentrated and distributed loads can be applied with respect to the local or global coordinate system. Directions are distinguished with coordinate letters {X, Y, or Z} for global coordinates and {x, y, or z} for local coordinates. The local axes and corresponding loads can be reversed using the **Structure | Reverse Local Axes** command or the sign of the magnitude can reverse the action of the load in the local or global coordinate systems. Member loads are always assumed

to pass through the centroid or shear center of the member. Distributed loads can be applied to the projected length of a member, which is typical for applying snow loads to a sloped roof.

## Load Location

Member loads are located from the starting node (Node 1) of the member using an offset along the length. For distributed loads, both the starting offset and the ending offset are measured from Node 1. There is an On Full Span option which specifies that the distributed load converse the entire span from Node 1 to Node 2. Multiple distributed loads may be applied on a single member, but cannot overlap.

## Generating Multiple Member Point Loads

VisualAnalysis has two features for generating multiple point loads across members at once. Select either Fractional Span Points or Evenly Spaced Points to generate multiple concentrated loads on each member. Fractional loads can be placed randomly (they work well for placing loads at say 1/3 points of members with different span lengths). Use the evenly spaced option to create loads a fixed distance apart. Although the multiple point loads are generated in a single step, they immediately become independent concentrated loads for editing or deleting.

## Eccentric Loads

Eccentric loads cannot be applied to a member in VisualAnalysis. All member loads pass through the centroid or shear center to cause no secondary effects. Both the load and the associated moment must be applied manually can account for load eccentricity in the model.

## Ice Weight

The Ice Weight for members in VisualAnalysis is calculated according to the ASCE 7 provisions. When a Service Case has a Dead (Ice) load Source, the Ice Weight Load Type becomes available in the Add Members Load(s) dialog box. VisualAnalysis can automatically calculate the design ice thickness for the member based on the specified nominal ice thickness, the importance factor, the height factor, and the topographic factor (wind parameters must be defined for the ice service case). Alternatively, the design ice thickness can be manually specified in the program. The diameter of the smallest circle that would contain the shape's cross-section and the design ice thickness is used to determine the cross-sectional area of ice. A conservative value of 56 pcf is used for the ice density to determine the magnitude of the uniform load in VisualAnalysis. Ice weights always act in the project's vertical direction.

## Wind (+ Ice Area) Loads on Members

When a Wind Load Case is selected, the Wind (+ Ice Area) Load Type is available in the Add Members Load(s) dialog box. The load case wide wind parameters and the project wide IBC wind parameters are specified in the Service Case dialog box.

## Wind Velocity Pressure

VisualAnalysis calculates the wind velocity pressure,  $q_z$ , according to the ASCE 7 provisions. The velocity pressure is a function of various parameters specified in the wind [Service Case](#). Wind (+ Ice Area) loads are applied as constant uniform loads over the length of the member where the average height of the member is used to determine the wind velocity pressure.

## Design Wind Load

The design wind pressure,  $p$ , can be manually specified or VisualAnalysis can automatically calculate the member design wind pressure according to the ASCE 7 provisions as follows:

$$p = q_z G C_f$$

Where:

$q_z$  = Velocity pressure per ASCE 7

$G$  = Gust factor

$C_f$  = Force coefficient

The gust factor,  $G$ , is specified under the project wide IBC wind settings. By default, the force coefficient,  $C_f$ , is determined according to the ASCE Substation Structure Design Guide and the aspect ratio correction factor,  $c$ , is used to modify the force coefficient as discussed in the design guide.<sup>1</sup> The  $C_f$  value can be manually overridden to use values from ASCE 7 for various types of structures. The design wind pressure is used to determine the design wind uniform load for members which is calculated as follows:

$$w_{\text{wind}} = p d_{\text{proj}} L_{\text{proj}} / L$$

Where:

$p$  = design wind pressure

$d_{\text{proj}}$  = The projected depth of the member's cross-section including the design ice thickness,  $t_d$  (see image below)

$L_{\text{proj}}$  = Projected length of member in the plane normal to the wind's direction (note: the length reduces as the orientation of the member becomes closer to parallel to the wind direction)

$L$  = Length of member

Note: The projected depth,  $d_{\text{proj}}$ , depends on the direction of the wind as shown in the image below. When the direction of the wind aligns with one of the member's local coordinate axes, the projected depth of the shape including the design ice thickness is used in the calculation. When the direction of the wind does not align with one of the member's local coordinate axes, the projected depth is conservatively taken as the smallest diameter a circle that can circumscribe the member's cross-section including the design ice thickness. VisualAnalysis can automatically calculate the design ice thickness for the member based on the specified nominal ice thickness, the importance factor, the height factor, and the topographic factor. Alternatively, the design ice thickness can be manually specified in the program.

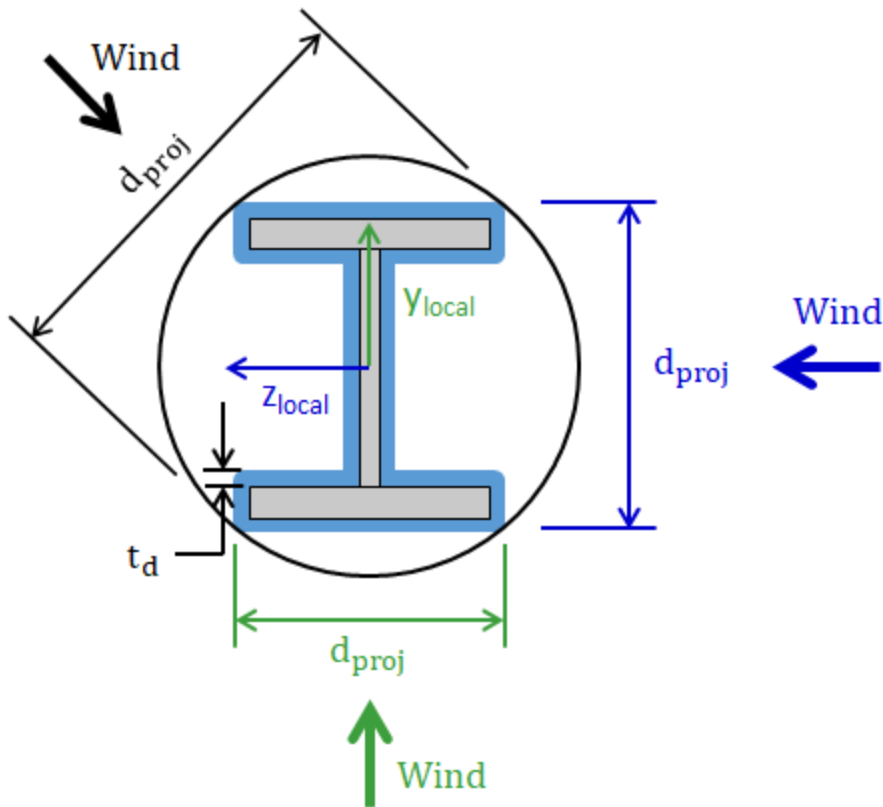

**Projected Depth Based on Wind Direction**

## References

1. Kempner, Leon Jr. Substation Structure Design Guide. ASCE Manuals and Reports on Engineering Practice No. 113. American Society of Civil Engineers. p. 40-41, (2007).

## 3.5 Plate Loads

Plate loads are applied to selected plates using the **Loading | Apply Plate Loads** command or the **Ctrl+4** hotkey. Plate loads can be applied to individual plates or across a plate mesh. Plate element loads are applied as equivalent nodal loads. Therefore, plate bending cannot be achieved from a single plate element and a plate mesh is required to get accurate plate behavior. Note: Area loads are often more convenient to work with than plate loads since they can be modified independently of the plates themselves and will not get deleted if the plate elements are removed or re-configured in the model.

### Plate Load Types

The following Load Types are available for members:

- **Uniform** - A pressure applied uniformly across a plate element
- **Linear** - A pressure applied linearly across a plate and specified at each node (corner) of the plate
- **Hydrostatic (mesh)** - A linear pressure based on a global fluid level applied to a mesh of plates

- **Linear (mesh)** - A pressure applied linearly across a mesh of plates
- **Temp Change** - A change in a plate's temperature which influences the plate's in-plane forces and/or displacements
- **Thermal Gradient** - A change in a plate's temperature gradient which influences the plate's bending moments and/or displacements

## Load Directions

All plate loads act perpendicular to the plate element to cause bending, except for the Temperature Change load which acts in-plane. Positive loads act in the local+z direction while negative loads act in the local -z direction. Use the [Structure | Reverse Local Axes](#) command to reverse the local axes of a plate and the corresponding load direction.

## Across Mesh Loads

When applying linear or hydrostatic loads across a plate mesh the definition of the load depends upon global coordinates. It is possible to define loads that do not vary across the plates (uniform loads) or to create loads that have zero magnitude so check the model closely. Once loads are created for the "mesh," the loads are independent and can be scaled, modified, or deleted separately. Their definitions, however, still depend on the specified global coordinate locations and moving or modifying plate elements can cause the magnitude of the loads to increase, decrease or become zero.

## Apply Concentrated Loads and Edge Loads on Plates?

VisualAnalysis does not directly support concentrated loads or edge loads (in-plane or out-of-plane) on plate elements. Typically, a mesh of plates is used and concentrated loads are applied to a node for one of the meshed plates. Edge loads can be applied manually to nodes along the edge or a member element can be created along the edge of a plate mesh for loading purposes. Note: Members and plates are only connected at common nodes. Also [Areas](#) and [Area Loads](#) can be used to apply loads to the edge of a plate mesh.

## 3.6 Area Loads

Areas can be used to create loads that are independent of the model. Area Loads are automatically distributed to model elements based on tributary areas and the [Span Data](#). Area Loads are applied to selected areas using the [Loading | Apply Area Loads](#) command or the [Ctrl+3](#) hotkey. Area Loads apply only to objects that lie within the boundary and plane of an area (i.e. loads will not project onto elements that are not in the plane).

### Area Loads on Plates

When area loads are applied to plates, the pressures are transmitted directly to the plate elements within the plane and confines of the area. If there are holes in the plate mesh, then no load will be applied over this portion of the mesh (i.e. loads are not 'distributed' to nearby plates). If an area load extends beyond the plate element mesh or is completely within a single plate element (but not completely over that plate), then the loads may not be generated as expected. Enable the Generated Loads parameter under the Load Details in the [Project Manager | Model Filter](#) tab to validate how the loads were applied to the plates for analysis. A Generated Plate Loads report table can be created to validate how the load were applied to the plates.

### Tributary Area Loads on Members

Area loads are distributed to members according to the [Span Type](#) specified for the area (either a one-way or two-way distribution can be chosen). [Member Offsets](#) will not prevent a member from receiving load from an area (i.e. members whose nodes lie in the plane of the area will be loaded). The Load Braces parameter for an Area can be disabled to prevent members with a bracing framing type from receiving any load from the area. Tributary area loads applied to



members are generated numerically through numerical-integration, which is an approximation (the accuracy is a function of the size of the area, the arrangement of members in the plane, and the [Project Manager | Modify | Performance](#) settings in the project). Enable the Generated Loads parameter under the Load Details in the [Project Manager | Model Filter](#) tab to validate how the loads were applied to the members for analysis. A Generated Member Loads report table can be created to validate how the load were applied to the members.

## [ASCE 7 Wind Loads on Areas](#)

VisualAnalysis has a built in wind-load generator that can help with ASCE 7 Wind load application. The generator is based on the Directional Procedure (Wind Loads on Building- MWFRS) in Chapter 27 of the ASCE 7 design specification for Enclosed and Partially Enclosed buildings (Open structures are not supported for Area Loads). The generator calculates the pressure on the area based on the wind parameters that are set for each load, each load case, and for the entire project.

### Steps to Create Area Wind Loads:

1. Create one or more Areas to accept a wind load pressure
2. Select or Create a Service case with a Wind Load Source (Wind+X, Wind-X, Wind+X+Y, etc.)
3. Apply an Area Load(s) to the selected Area(s) using the [Loading | Apply Area Load](#) command in the wind load service case
4. Select the Area Load(s) and set their Type to ASCE 7 Wind in Area Loads section of the [Project Manager | Modify](#) tab. Also, specify the Apply To parameters.
5. Specify the Outward Area Normal parameter and select the Wind Surface from the dropdown in the Wind Load section of the [Project Manager | Modify](#) tab.
6. Define the Wind Parameters (Exposure Category, Enclosure Category, Project Width, etc.) for the specific Load Case by using the [Loading | Edit Load Case](#) command or in the [Project Manager | Modify](#) tab when a wind load is selected in the Model View.
7. Define the project wide IBC Wind parameters (Ground Elevation, Mean Roof Height, Wind Speed, Gust Factor) using the [Loading | Edit Load Case](#) command in any wind Load Case or in the [Project Manager | Modify](#) tab when a wind load is selected in the Model View.
8. The Calculated Pressure for a selected area load is displayed in the Wind Load section of the [Project Manager | Modify](#) tab. The calculated Area Wind Load pressures are also displayed in the Find Tool.

## Area Side Loads

### Requires: Advanced Level

A uniform force or moment can be applied to area sides (in any direction, including in the plane of the area) by selecting the side and using the [Loading | Apply Area Side Load](#) command. The Area Side Load is distributed to the nodes along the edge (both manually created nodes and nodes from auto-meshing). If the sides for an area cannot be seen in the Model View, make sure the Sides parameter is enabled in the Area Details section of the [Project Manager | Model Filter](#) tab. If the sides are still not visible, select the area and enable the Auto Generate Sides? parameter in the [Project Manager | Modify](#) tab or use the [Structure | Add Area Sides](#) command to generate the sides manually.

## 3.7 Load Cases and Combinations

### [Load Case and Combination Types](#)

Case Type	Description
<b>Service Load Case</b>	A container for holding physical loads, usually grouped by load source. May also include self-weight of the model. These cases may be analyzed or not, and may be 'patterned' for live loads (advanced). For wind loads there are settings specific to ASCE7 that you may use in conjunction with area loads. These are <b>not</b> used directly for <a href="#">design checks</a> .
<b>Building Code Combination</b>	Automatic load combinations are generated based on defined <a href="#">building code equations</a> . You cannot edit or modify these except by selecting or unselecting building codes or converting these to custom (Factored) combinations.
<b>Factored Combination</b>	A way of combining service cases with arbitrary load factors. These are good for patterned loading and other custom load combinations where you are picking & choosing the cases and factors. These can be used for <a href="#">design checks</a> .
<b>Dynamic Response Case</b>	A way of specifying a seismic event along with direction factors. Dynamic response case results are computed by combining results from mode shapes. <b>No design checks</b> directly -- use a superposition combination.

## Requires: Advanced Level

Advanced Cases	Description
<b>Time History Case</b>	A load case that applies a 'forcing function' load that varies with time. <b>No design checks</b> directly -- use a superposition combination.
<b><a href="#">Moving Load Case</a></b>	A load case for applying simple moving loads (a truck and/or patterned uniform) along a single beam-line. Moving loads produce envelope results and are handled independently of other load cases during analysis. <b>No design checks</b> directly -- use a superposition combination.
<b><a href="#">Result Superposition Combination</a></b>	This is a post-analysis load combination. These are used to combine time-history results, dynamic response results, and moving load results with normal static results. Note that these load combinations are really just an "envelope" with extreme+ and extreme- values. Superposition combinations may not be accurate in the presence of nonlinear features! <b>Design checks may be performed</b> on superposition combinations if you mark them for design (ASD or LRFD or Deflection)

## Service Load Cases

Service cases are used to organize the physical loads on a model, with an eye toward load combinations used for design checks. VisualAnalysis supports many different load types to represent physical loads on your model such as concentrated nodal loads, distributed member loads, etc. These physical or actual loads are grouped inside a container called a Service Load Case.

Each Service Load Case has a load source associated with it. The source defines the physical origin of the loading. Common load sources include dead load, live load, and wind load. Load sources are used to make load combinations easier. They are described in more detail below.

Most design codes require that you check various combinations of loads. The LRFD specification for steel, the ACI specification for concrete, and the IBC specification for buildings define combinations using equations like  $1.2D + 1.6L$ . In these combinations, loads are grouped according to their sources and given factors to account for the relative uncertainties. In many cases it is important, as a designer, to look at other loading configurations that may also take place. One such technique is called patterned loading. VisualAnalysis supports these operations through load cases.

## What are Load Sources?

VisualAnalysis provides convenient ways to both organize and combine your loads. Each Service Load Case can be defined as coming from a particular load source. These load sources are derived from the most common design specifications in the USA such as those produced by organizations such as ASCE, IBC, and AASHTO. There is a preference setting under **Tools | Preferences, Project** to specify which service load cases are set up when you start a new project. The default is to generate load cases for ASCE 7 sources only. You may manually create service load cases with any names you desire, without much regard to the "load source" definition.

The existence of a load source type in the software does not mean that a corresponding physical load is supported. For example, there is no "creep" load source available in VisualAnalysis that you use for loads on a concrete frame. However, you can still create member loads and place them in a load case to represent the effects of creep on your structure.

Load sources are used in VisualAnalysis to create Equation Combination load combinations and (automated) Building Code combinations. These load combinations allow you to combine groups of service loads together, while automatically applying the appropriate multiplication factors based on the source type. VisualAnalysis can also generate the set of factored combinations needed for working with LRFD, IBC, or ACI codes. The support is not entirely foolproof however as careful attention is needed for patterned loading situations and other possible complications. For more information refer to the Loading section.

Load **sources** are not customizable in VisualAnalysis. However, you may create any number of **service load cases** with arbitrary names and use them for whatever you like and create custom factored load combinations. The existence of a load source in VisualAnalysis does not imply that there are specific loads or calculations done in the software--these are just ways of organizing and combining your loads.

### Simple Load Sources

Load Source	Abbreviation
Dead	D
Live	L
Seismic (directional)	E+X, E-X, ...
Wind loads(directional)	W+X, W-X, ...

### ASCE 7 Load Sources

Load Source	IBC / ASCE 7	Explanation
Dead	D	Structure self-weight or permanent fixtures on or in the structure.
Ice Weight	Di	Weight of ice.
Live	L	Loads due to moveable equipment or occupancy. Live loads may be "patterned" in the advanced level, and if so are denoted with L1, L2, L3, etc. with a pattern ID. Caution: Live loads are reduced by 50% in some IBC load combinations, use Lpa source for loads > 100 psf.
Live (Public Assembly)	Lpa(> 100psf)	Garage loads, Public Assembly areas, or loads greater than 100psf. They have also been called "Exception" loads, because they appear in a separate clause in some building codes.
Roof Live	Lr	Live loads on a roof.

# VisualAnalysis 19 User's Guide

<b>Load Source</b>	<b>IBC / ASCE 7</b>	<b>Explanation</b>
<b>Rain or Ice</b>	R	Initial rainwater or ice exclusive of ponding contributions.
<b>Snow</b>	S	Snow loads. Notes: There is no separation in VisualAnalysis for non-shedding loads. There is no load 'source' for unbalanced snow loading, which should be handled like 'patterned loading' using multiple snow load cases and load combinations.
<b>Seismic (directional)</b>	E+X, E-X, E+Y, E-Y, E+Z, E-Z	Earthquake or Seismic loads. EX is for seismic loads in the positive global X direction, E-X is in for the negative global X direction, and similarly for the Y and Z directions.
<b>Seismic</b>	E	Earthquake or seismic loads to include with each of the directional seismic loads. (You should rarely need to use this, it is provided primarily for backward compatibility and ultimate flexibility!)
<b>Earth Pressure</b>	H	Loads due to differential settlement, backfill on a wall, etc.  Caution: Combinations do not distinguish the difference between H adds or resists the primary load variable in an equation. It is up to you to handle the load combinations for special circumstances with earth loading.
<b>Fluids</b>	F	Water in a tank.
<b>Flood</b>	Fa	The river flowing over your bridge or through your building.
<b>Temperature</b>	T	Thermal loads. IBC calls these self-straining loads.
<b>Wind loads (directional)</b>	W+X, W-X, W+Y, W-Y, W+Z, W-Z, and more!	Wind pressure loads. As in the seismic loads above, using just W will apply the same load in all directions. WX is for wind loads in the positive X direction, W-X is for wind loads in the negative X direction, and similarly for the Y and Z directions.  Optional "Skewed" wind load directions are available (+X+Y, -X+Y, +X-Y, etc.), enable these using <a href="#">Tools   Preferences, Project and</a> use them for your own custom load cases and combinations, but they are primarily here for backward compatibility
<b>Wind on Ice</b>	WiX, Wi-X,...	Wind on Ice. Ice will increase the surface-area of members and therefore the wind forces.
<b>Other loads</b>	U	<b>User-defined</b> source available for special loads that you want to factor independently of other sources. These are not used in Building Code Combinations.

## [Load Case Manager](#)

The load case manager is accessed by selecting [Loading | Load Case Manager](#). Essentially the load case manager is a convenient place to view and manage all load cases and load combinations. The only exception to this is the advanced-level [Project Envelope](#), which acts similar to a load case but is really just a 'result case'.

Load Case Manager is where you go to setup 'design load cases'. Load cases for design are either load combinations or superposition results. You may specify load cases to be checked for strength (ASD or LRFD) or deflections. See more about [design checks](#).

## [Service Load Cases](#)

Service load cases are containers for real loads. Typical service load cases are automatically created with a new project, but more can always be added by going to [Loading | Load Case Manager](#) and clicking on the Service Cases tab. The weight of a piece of machinery, the pressure of the wind, and the settlement of a support are all real, static loads that may be

included in a service load case. All static loads must reside in a service load case. Generally it is best to separate loads into easily managed groups based on load sources or some other preferred organization.

## Self Weight

Self-weight is automatically included in the Dead Load service case, in the vertical direction. The self-weight of the model itself is automatically calculated based on member, plate, and cable element properties, but can, if necessary be scaled or factored using the load case settings. Seismic load cases may also include the effect of self-weight, factored into a horizontal direction.

## Patterned Live Load Cases

### Requires: Advanced Level

Live load service cases may be given a positive pattern ID number to help you easily model various loading patterns, such as odd/even span loads. Each patterned service load case is combined independently in building code load combinations from other patterned load cases. For example, you can place odd-span loads in a "Pattern 1" service case and even-span loads in a "Pattern 2" case and the building code combination will generate something like:

$1.2D + 1.6L + 1.6L(1)$  (#1)

$1.2D + 1.6L + 1.6L(2)$  (#2)

Note any loads in a non-patterned live load case are included in both combinations. The built-in service cases all have load patterns of 0 by default and cannot be changed, you must create new service cases to define patterns.

## ASCE 7 Wind Load Settings

Service load cases that have a wind load source may be used to help generate [area loads](#) (e.g. for building surfaces) or [member loads](#) (e.g. for open towers) based on ASCE 7 criteria.

Note that you must manually apply loads to members or areas. The system is not automatic--VisualAnalysis helps with calculating pressures based on the input data.

The following case or project settings are **defined by ASCE 7**, but you will find 'tooltips' if you hover over the item in the Service Case dialog box:

### Per Wind Load Case

- Exposure Category
- Enclosure Category
- Projected Width
- Side Length
- Internal Pressure
- Roof Pressure
- Directionality Factor, Kd
- Topographic Effects (with numerous options!)
- Large Volume Reduction
- Air Density Adjustments

### Project-Wide Wind Settings

- Ground Elevation
- Mean Roof Height

# VisualAnalysis 19 User's Guide

- Wind Speed (mph)
- Gust Factor

## [ASCE 7 Seismic Settings](#)

The [Project Settings](#) allow you to define seismic parameters that are currently ONLY used in the generation of IBC or ASCE 7 load combinations in the Building Code Combination system. These settings determine the  $E_v$  +/-  $E_h$  portions of seismic loads and automatically include the vertical component as a function of your 'self weight' service loads "D". The system will use the rho factors and then also generate any required Overstrength load combinations. You will see the effects of this in the "*Effective Equation*" shown in the [Load Case Manager](#), or load combination reports.

## [Building Code Combinations](#)

Building code combinations from a variety of building codes are built-in to VisualAnalysis. When selected these combinations are automatically maintained as loads are added or removed to service load cases. The desired building code or codes to use are selected at the bottom of the [Load Combinations](#) tab of the [Load Case Manager](#). This system was designed for use with IBC or ASCE 7 load sources. If you are using the AASHTO load sources, you will need to manually generate (or import) your load combinations.

The building code combinations implemented in VisualAnalysis do not necessarily represent **all possible load combinations or variations** present in a particular building code. For example, in the implementation of ASCE 7-10 load combinations, the major equations are implemented, but exceptions clauses of section 2.4 dealing with H, F, Fa are not implemented directly. Similarly VisualAnalysis does not deal directly with T (self-straining) conditions at all--**so you may need to manually create custom load combinations** to deal with special circumstances.

### [How it Works](#)

When one of the building code combinations is selected, VisualAnalysis will use the current service load cases and generate the necessary combinations prescribed for that code. Note that any custom equation or factored combinations that are created manually will remain unaffected. When VisualAnalysis generates building code combinations, it will generate combinations including the effects of wind and seismic in various directions, including (+/-X, +/-Y, +/-Z). Only load cases that actually contain loads or self-weight are included in the combinations. The Load Case Manager will then display the 'effective' combination of the equation which may be different than the equation in the building code.

### [Controlling Performance](#)

Reducing the number of load combinations to analyze and report may **dramatically improve performance**. Select only the load combinations you need! Do not pick, for example, both IBC and ASCE 7 combinations, use one or the other--they differ primarily in naming scheme.

The automatic system is fast, convenient, and comprehensive--but not very intelligent. You can end up with redundant load combinations, depending on the actual loads you have applied. One of the biggest drains on VisualAnalysis performance is having extra load combinations to analyze, check, and report. You can convert all the combinations to manual combinations and take full control.

### [A Customizable System!](#)

The building code combination system is fully customizable You may manually add, remove, or disable sets of code equations, or add, edit, or remove individual equations from the sets. There is a hyperlink on the [Load Combinations](#) tab of [Load Case Manager](#) that allows customization.

 If you had custom combinations in VA 12.0 or prior, they are not available, you will need to re-enter them. See the [Upgrade Guide](#) for more.

## Live Load Reduction

### Requires: 2D Design Level

You may specify one or more levels for reducing live loads. This feature takes any service cases with the source as Live Loads and combines them at reduced levels using the building code combination feature. In effect you will generate additional load combinations, one set for each level you enable. You can then associate a [Design Group](#) with one of these levels to take advantage of the reduced demands.

## Factored Load Combinations

When an equation load combination does not work, a Factored Load Combination should be used which lists all desired load cases with a specified factor. One common use for this type of load combination is patterned loading. In this case, multiple load cases might have the same source, yet require different factors for each. Use the **Create a Factored Load Combination** button located in the **Load Case Manager** to create a new combination.

Sometimes you want to combine loads with different factors on cases with the same source. For example, two live load cases may need to be included in the same combination, but a load factor of 1 on the first and 1.5 on the second is desired. Factored load combinations are more flexible than the equation load combinations because factors can be explicitly set to each load case regardless of source.

Custom factored load combinations can be imported through the [Clipboard](#) exchange and through the load case manager. In both cases, the format is the same. The best way to learn the import format (and to setup a spreadsheet to import load combinations) is to export a custom load combination through the clipboard exchange.

## Response Load Cases

To perform a dynamic response analysis you need to have at least one Response Load Case defined. A response case contains direction multipliers and a design spectrum. Use **Loading | Load Case Manager** and click on the Dynamic tab to create a Response Load Case.

The direction multipliers define the direction of the seismic event and also scale the magnitude. You might think of them as direction cosines. If you want to simulate an earthquake in the X direction use  $X=1, Y=Z=0$ . Similarly to indicate the direction in the XZ plane, 45 degrees off the X-axis, use  $X=Z=0.707$  and  $Y=0$ . If the square root of the sum of the squares of the direction cosines adds up to a number other than 1.0, then this scale factor is also applied.

The design spectrum is a data set representing a seismic event. Building codes often provide design spectra to use, or you may have more accurate local information from previous events. The data represents a time history of displacements or accelerations. You can include your own custom data in the file (the default is 'Spectrum.txt' located in the [Customizable Data folder](#)).

## 3.8 Dynamic Loads

### Include Mass of Model

The mass of member and plate elements is automatically calculated and included in a dynamic analysis. Internally, these masses are distributed to the nodes. For more accurate dynamic modeling, consider splitting members and plates to get a better distribution of mass.

### Apply Extra Nodal Mass

Additional mass in your model can be specified through using lumped nodal mass. Use the Modify tab in Project Manager to edit nodes to define additional displacement mass or rotational mass at this location in the structure.

Nodal masses are entered weight units. It may be easier to apply extra mass as static loads that are included through the **Mode Shape Case**, where you can include all the loads from a specified service case as dynamic mass.

The self-weight of the model is included automatically in the dynamic analysis.

## **Use Static Loads for Additional Mass**

One way to include additional mass on a model is to specify a single static load case in the Load Case Manager. This may be a Service Load Case or one of the factored load combinations. The direction gravity is acting must also be specified. Only loads with a component in the gravity direction will be included in the mass calculation.

The self-weight of the model is included automatically in the [dynamic analysis](#).

## **Use Response Spectra**

A Response Spectrum Analysis determines the behavior of the structure when subjected to a specified ground acceleration or displacement, e.g., an earthquake. The magnitude of the acceleration or displacement is a function of time and is referred to as a Design Spectrum in VisualAnalysis. Building codes often prescribe a seismic Design Spectrum. Include a Design Spectrum in a Response Load Case using **Loading | New Response Case**. The dynamic response load case associates a specific Response Spectrum with the analysis and provides for direction and scaling factors to adjust how the data is used for each particular analysis.

You also need to define the method for combining mode shapes. The default (best) method is CQC, but SRSS is also available, and there is a damping factor that you may need to adjust--steel behaves differently than concrete, for example.

## **Create a Custom Response Spectrum**

The data for response spectra used in VisualAnalysis is stored in a text file called [spectrum.txt](#). A specific earthquake's ground motion or other historical seismic data can be added here as a custom response spectrum. VisualAnalysis includes a few predefined sets of data, and you can generate new data per IBC using the **Loading | Generate Response Spectrum** command.

## 3.9 Moving Loads

**Requires: Advanced Level**

### **Introduction**

Moving Loads are an analysis feature to model truck loads on bridges or crane loads on girders. These loads can move along the length of the members in either the positive x-direction or in both directions when defined to be reversible. This tool eliminates the need to create multiple load cases to simulate moving loads and provides intelligent reporting capabilities. Two pre-defined truck loads (the AASHTO HS 20 Short and the AASHTO HS 20 Long) are provided by default and custom truck and lane loads can be created.

### **Truck Generator**

Custom Trucks can be created, modified, or deleted using the **Loading | Truck Manager**. For each truck, provide a name, define the magnitude and offsets for the axels, and set the magnitude of the lane load. Custom Trucks are saved in the Truck.xml [Custom Data File](#) in the **Tools | Custom Data** folder and can be used in different VisualAnalysis projects.

### **Applying Moving Loads**



## Creating Moving Loads

Moving loads are created using the Create Moving Load button on the Advanced tab of the Load Case Manager. In the Moving Load Case dialog, define the Name, select the Truck, specify if the load is Reversible, and set the Require Axis Match parameter. Next, select the members that will carry the moving load (note: members selected in the model view will automatically be selected in the Moving Load Case dialog). For a moving load to be applied to multiple members, the members must form a valid chain.

## Editing Moving Loads

Moving Load cases can be modified by selecting the load graphically in the Model View or in the [Find Tool | Moving Load](#) tab. Once selected, the parameters for the moving load will appear in the [Project Manager | Modify](#) tab.

## Analysis Options

The Moving Load feature works by creating and analyzing a series of load cases in the background that place the truck loads at incremental distances starting at one end of the member and moving across to the other end. The number of points where the load is placed along each member is determined by the number of Load Stepping Points parameter defined in the Advanced Analysis section of the [Project Manager | Modify](#) tab. Increasing this number may yield more precise results, but will also increase the size of your project file, slow the performance of the analysis, and increase the output in reports. Note: A nonlinear model will preclude the use of moving loads since the analysis relies on superposition, which is invalid for nonlinear models.

## Results

Moving Load Cases results are presented in Extreme Min. and Extreme Max. envelope. Moving Load Cases can also be combined with results from any other type of load case using [Result Superposition](#). The Moving Load results also offer Influence Diagrams for nodes or members at specified points in the model.

## Influence Diagrams

When a Moving Load Case is analyzed, the influence diagrams are automatically created for the member(s) and the Influence Diagram window tab will appear. Influence Diagrams are available for any node or member in the structure. Select the member or node in the Model View and switch to the Influence Diagram window to view the diagram for the selected item. With the Influence Diagram window selected, define the Graph Details parameters in the [Project Manager | Modify](#) tab. For members, adjust the Offset to see the influence diagram at various locations along the member.

## Influence Refresher

Influence lines represent the effect of the moving load on a particular point in the model as the load moves. Influence diagrams are constructed for a positive (upward Global Y) 1 kip point load. The vertical axis shows the magnitude of the result in question when the 1 kip load is applied, while the horizontal axis shows the position of the 1 kip load along the member chain. The typical use for these influence diagrams is to determine where to place other (perhaps non-moving) loads to achieve a maximum effect at some point in the structure. The moving load analysis does this automatically for the moving truck loads and lane loads, but this tool can be used to determine where to position loads in another load case.

## Design Checks

To obtain a design check for the results of moving loads, a [Result Superposition](#) case must be created in the [Load Case Manager | Advanced](#) tab and the appropriate Design Category must be specified.

## Reporting Moving Load Case Results

## Report Tables

Members subject to moving load are reported similar to members applied with other standard loads. Report tables, such as Member Forces, Member Stresses, etc. work are available for moving load cases. A table to report the Moving Loads that have been defined is also available.

## Determining Load Location for a Result

The results presented for moving load cases are envelope results. To find where the truck was when a given force or moment occurred in a member include the corresponding "When" column (Fx When, Vy When, Mz When, etc.) in the report. The "When" columns can be added from the Columns to Display section of the **Project Manager | Selected Table** tab. Note: The "When" report column does not return a location if the truck consists of only a lane load (i.e. the truck has no axels).

## Limitations

- VisualAnalysis does not provide full AASHTO support
- Moving Loads can only be applied to a contiguous chain of members. To load two different chains of members with moving loads, two Moving Load Cases must be created.
- Only one truck is allowed per moving load case
- Moving loads can only be applied to member elements in the Global Y-direction.
- There is no way to distribute the moving loads laterally to multiple member chains.
- Moving Loads cannot be applied directly to plate elements, but they can be applied to members in a structure that contains plates.
- Moving loads cannot be used with nonlinear structural elements since the principle of superposition is used to calculate moving load results. Therefore, moving load results are not available when cable elements, semi-rigid connections, one-way elements or springs, etc. are used in the model.

## 3.10 ASCE Load Helper

The ASCE load helper is used to apply the predefined ASCE 7 dead or live loads to nodes, members, plates, or areas. The loads that are defined in the helper are saved in a UserLoads.xml file in the [IES Data Folder](#) and are available for future projects.

### Defining Loads

#### Dead Load

Dead loads are defined using the **Loading | ASCE Load Helper** command on the main menu. In the Dead Load tab, various ASCE materials can be selected, combined, and a custom name can be given to the group of components.

#### Live Load

Live Loads are defined using the **Loading | ASCE Load Helper** command on the main menu. In the Live Load tab, various ASCE Live Loads can be selected or Custom Live Loads can be created.

### Applying ASCE Loads

ASCE Loads can be applied to nodes, members, plates, or areas. ASCE Dead Loads and ASCE Live Loads can only be applied in Service Cases that have Dead and Live load sources, respectively. When adding a load to the model, an ASCE 7 Load can be selected in the Magnitude section if one is available. Tributary widths must be specified for nodal

force loads and uniform member loads since ASCE 7 Loads are defined as uniform pressures.

## 4 Analyze

### 4.1 How To

#### 4.1.1 Working in Result View

The Result View is your primary access point for graphical and numerical analysis results. You will use this view to see analysis results graphically. It provides filters, legends, and images to help you find the information you need quickly. It also works well as a starting point for generating printed reports of selected objects. A Result View shows the results of one result case at a time. In the advanced level of VisualAnalysis, you will also have the ability to view envelope (or extreme) results.

Result Views can be used as interactive or printed reports themselves. Use **File | Print Preview** to see how a Result View will look when printed.

#### **Waiting For Results?**

Analysis happens automatically on a background-thread when the CPU has 'spare time', whenever you make changes in your model. Switch to a Result View to see the results, or view the status if the results are not read. **Double-click** on the progress text at the bottom of the window (status bar) to get more detailed information about background processing and progress. Most models will analyze in a few minutes or less, if you are waiting long times for analysis, consider the [analysis performance](#) options available.

#### **Use the View Filter**

Use the **Result Filter** tab of **Project Manager** to determine which results are displayed. You can toggle the displaced shape, on-frame diagrams, or show color contours. You can include extreme force (or displacement or stress) labels, as well as object names and some properties. The filter will help you see only the information you need, while hiding that which is not important. If you turn on the undisplaced shape, you will get a **Model Filter** to control how that is shown.

#### **Showing Member or Plate Results**

On the **Result Filter** tab of Project Manager, use the **Results** option under **Members** or **Plates** to change the types of results to display. These include displacements, forces, and stresses.

#### **Display On-Frame Graphs**

Choosing Diagram from the **Graphics** drop down list under the **Filter** tab of Project Manager will display on-frame member graphs. By default the displaced shape is disabled when this option is chosen to clarify the diagrams. If you prefer to view the displaced shape and the member diagram you can always turn the displaced shape back on.

#### **Use Result Legends**

Legends are small windows that float in the Result View, when enabled. This is useful for interpreting the colors used in plots and for finding the extreme values for all objects or selected objects when diagrams are shown. Members and plates each have a separate legend and they can be turned on or off independently. These legends may be dragged to any position within the window, and they are included if you print the window.

The legend may display one or more "Range Controls". These controls will allow you to filter the Result View to show only results in a specified range of values. To restrict the range, **Drag** the top or bottom arrow with the mouse.

#### **Create a Member or Node Result Graphs**

You can create a detailed moment, shear and deflection diagrams using the Member Graph command. You may select one member or a chain of multiple member elements (that form a straight line) to graph. For moving load results, you can also create influence line graphs for nodes or members.

## Create Plate Result Graphs

Detailed diagrams for moment, shear and deflections are available for a plate mesh as well. To access the feature, filter on the result you wish to see using the Project Manager, Result Filter, Plate Results option, then **drag the mouse on a line** across the plate mesh where you would like to see the graph.

## Find Results

The **Result** tab of **Project Manager** is used to quickly get a feel for the Extreme Absolute, Maximum positive, or Minimum negative value of each result for the current result case. You will find a Statics Check for each direction, information about your model's self-weight and center of gravity, and summary information for dynamic results. The Result tab is dynamic, based on the selection state in the active Result View, so you can use it to quickly get information about a specific element or node.

The *Help Pane* at the bottom of **Project Manager** shows result tips if you hold your mouse over an object (no need to select it!).

The **Find** tool shows various result tables just like you would see in a report, these tables can be sorted on any column by clicking the column header.

## Animate Results

While viewing a Result View, you can **right-click** and choose the **Animate Results** command from the context menu. You can use this to see how the structure deflects, or how member forces change. If you animate a time history result case, we animate all the time steps available. To cancel the animation, **right-click** the mouse in the view. If you display the window title, you can see the time step changing during the animation.

## Printing

See [Model View](#) for tips on printing graphics.

## 4.2 Analysis Topics

### Introduction

VisualAnalysis performs a Finite Element Analysis (FEA) to determine the behavior (displacements, reactions, internal forces, etc.) of the structural model under the applied loads. Prior to analyzing complex problems, it is best to analyze simple problems with known solutions to ensure that the program is being used correctly and is producing the results as expected. The finite element analysis is performed automatically on a background-thread whenever a change is made to the model. Switch to the Result View to see the analysis results (view the Status if the results are not ready). Double-click on the Status Bar at the bottom of the window to view the Pipeline status and get more detailed information about progress of the background analysis.

### Analysis Topics

- [Understanding Analysis](#)
- [Static Analysis](#)

# VisualAnalysis 19 User's Guide

- [Dynamic Analysis](#)
- [Analysis Performance](#)
- [Batch-File Analysis](#)

## Advanced Analysis

- [Nonlinear Analysis](#)
- [Time History Analysis](#)
- [Envelope Analysis](#)
- [Result Superposition](#)

## References

The following references might be helpful to engineers who are interested in learning more about finite element analysis methods.

1. S. S. Quek, G. R. Liu. [Finite Element Method: A Practical Course](#). Butterworth-Heinemann, 2003, ISBN: 978-0750658669
2. Robert D. Cook. [Finite Element Modeling for Stress Analysis](#). John Wiley & Sons, 1995, ISBN: 978-0471107743
3. Mario Paz. [Structural Dynamics Theory and Computation](#). Van Nostrand Reinhold, 3rd Edition, 1991, ISBN: 978-1461579205

## 4.3 Understanding Analysis

VisualAnalysis uses the Finite Element Analysis (FEA) method. While the inner workings of the FEA numerical procedure in VisualAnalysis are beyond the scope of this help file, this section offers practical guidelines for applying the method.

### Model Check

Use the **Tools | Model Check** command to check the model and ensure that it is ready for analysis. The Model Check information is displayed in the Report View. For the analysis to be performed, the model must follow the guidelines listed below.

1. Geometry is properly defined using members, plates, and springs. The model does not contain a mechanism.
2. The nodes are properly constrained to prevent the model from experiencing rigid body displacement or rotation.
3. The model must be loaded (i.e. the included load cases must not all be empty).
4. Second order (P-Delta) analysis cannot contain one-way members or one-way spring supports.
5. Mode-shape or response spectrum dynamic analysis cannot contain one-way members or one-way spring supports.

### Statics Checks

A Statics Check is performed for each load case analyzed in VisualAnalysis. The total applied loads in each global direction is calculated and compared to the sum of all support reactions in the corresponding global directions. The applied loads are based on the deformed shape of the structure while the reactions are based on the structure's undeformed shape. If the loads and reaction are equal and opposite in magnitude, then the structure is in equilibrium. An imbalance indicates that the deflections are large enough to generate inaccurate results which might indicate that there is a modeling problem. VisualAnalysis provides a warning if a significant imbalance is detected. If a warning is received, carefully review the model to ensure it is set up correctly and verify the results. The Statics Check is displayed on the **Project Manager | Results** tab or the Statics Check Information table can be added to the report.

## What to Look For?

Check to see if displacements and stress-levels in the model are reasonable and expected. A large force imbalance, either in percentage or in absolute value is a problem that cannot be ignored. Errors are usually caused by large displacements or rotations which can result from global or localized problems.

## What to Do?

If the statics imbalance is found in a first-order analysis, perform a second-order (P-Delta) analysis to see if the imbalance decreases. If the imbalance does not change or gets worse consider supporting the structure more or reducing the applied loads.

## Analysis Limitations

### Large Displacements

When a first order analysis is performed in VisualAnalysis, it is assumed that the deformation of the structure is not large enough to severely affect equilibrium. When a second order (P-delta) analysis is performed, however, the analysis includes secondary effects resulting from geometric stiffening or softening in the structure. Typically, compression softens a structure and tension stiffens a structure. In general, P-delta analysis are only valid for small to moderate displacements. VisualAnalysis does not use finite elements that can handle large displacements, therefore if the displacements appear large they should be carefully reviewed as the FEA results may differ from the real-world behavior. VisualAnalysis tries to detect large displacements and produce a warning, however, the definition of a large displacement is somewhat arbitrary. Structures with misapplied loads or incorrectly entered geometric or material properties can produce results with large displacements. Also, large displacements can arise if unreasonable preliminary sizes are used for members or plates. The Statics Check, as discussed above, will indicate if the equilibrium of the structure is not satisfied due to large displacements and if the results should be questioned.

### Material Nonlinearity

Materials in VisualAnalysis are assumed to be linear, elastic, and isotropic. It is possible for elements in the model to have stresses that exceed the yielding, cracking, crushing, buckling, etc. capacity in reality. While VisualAnalysis provides some checks against abnormally large stresses, it is important to verify that the element forces and stresses are within reasonable limits. If the elements in the model are allowed to exceed the stress where material nonlinearity occurs, the model can produce results that are stiffer than reality as shown in the figure below.

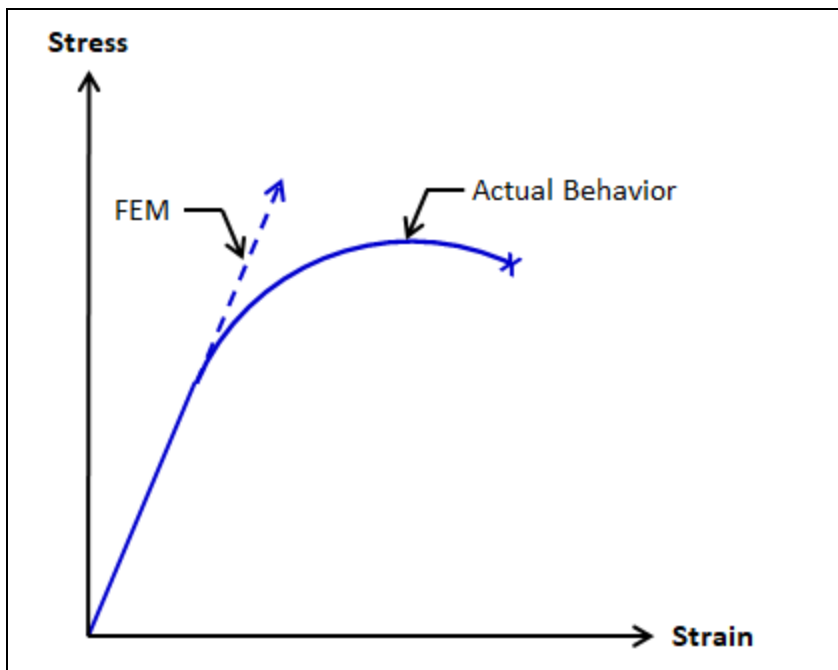

## 4.4 Nonlinear Theory

### Linear Assumptions

In a linear analysis, the response is directly proportional to the load, displacements and rotations are assumed to be small, supports do not settle, stress is directly proportional to strain (according to Young's Modulus), and loads maintain their original directions as the structure deforms. In general, equilibrium equations are written for the original support conditions, elastic stress-strain relations, load-free configuration, and load directions.

### Nonlinear Issues

Unfortunately, for nonlinear analysis, the linear assumptions are no longer true. Nonlinearity makes a problem more complicated because equations that describe the solution must incorporate conditions not fully known until the solution is known - i.e. the actual configuration, loading condition, state of stress, and support condition. Therefore, the solution cannot be determined in a single step and iteration is necessary to converge on the correct solution.

In a sense a nonlinear analysis is somewhat more restrictive than a linear analysis. For example, **the principle of superposition does not apply**; we cannot scale results in proportion to load or combine results from different load cases as in a linear analysis. Accordingly, each individual load case requires a separate analysis. In essence, we just want you to be aware that many of these new features use nonlinear analysis techniques and the assumptions and results should be interpreted carefully.

### Geometric Nonlinearity

Nonlinear problems are widely categorized in two categories; geometric and material. A common example of geometric nonlinearity is a cantilevered beam with a very large tip load. As the beam deflects it rotates and the tip load "follows" the beam thereby not acting solely in the direction it was originally applied. The [cable elements](#) are a prime example of geometrical nonlinear behavior.

### Material Nonlinearity



A common example of material nonlinearity is cracking concrete. As you load a concrete member near its ultimate capacity and beyond it exhibits highly nonlinear behavior due to the concrete material. Another example is the formation of a plastic-hinge in steel.

## Types of Nonlinear Analysis in VisualAnalysis

The use of some nonlinear features in VisualAnalysis will preclude the use of others in the same project. If you find a feature disabled, it could be due to other features already present in your model.

- **One-Way Elements:** Add tension-only or compression-only members or [spring supports](#) to the model to get an iterated first-order analysis that adds/removes elements, providing nonlinear results.
- **P-Delta:** Iterated first-order analysis to include 2nd-order effects
- **AISC Direct Analysis:** Iterated P-Delta Analysis, including out-of-alignment adjustments, reduced stiffness of steel members, and notional loading.
- **Time History:** Time-dependent effects (forcing function) and inertial terms. You create a Time History Load Case to get this.
- **Cable Elements:** Add cable elements to the model to get a nonlinear analysis.
- **Semi-Rigid Member Ends:** Yielding or cracking as a function of load at the ends of a member element. Mark the end(s) of members as semi-rigid connections to get a nonlinear analysis.

## References

For more about nonlinear analysis and other aspects of finite element analysis there is a good text by Cook that we recommend.

1. [Finite Element Modeling for Stress Analysis](#) by Robert D. Cook. John Wiley & Sons, 1995 ISBN 0-471-10774-3.

## 4.5 Analysis Performance

Analysis performance is proportional to the number of nodes,  $N$ , you have in your model, with analysis-time increasing on the order of  $N^3$ . It is also directly proportional to the number of load cases and combinations that you analyze. Memory requirements are similarly impacted, though less so as VisualAnalysis now uses a 64-bit memory model, limited essentially by the RAM memory you have installed. The information here will help you 'contain' your projects and get solutions.

Other factors that will directly impact your analysis-time include nonlinear features such as one-way elements, semi-rigid end connections, and cable elements. Time-history and moving loads are also relatively expensive.

### Understand Member Results

The member element in VisualAnalysis can be used to accurately model behavior for a multitude of applied loads. End forces and rotations in a static analysis are "exact" based on the elasticity theory. However, intermediate results along the length of a member are calculated only at discrete positions. This leads to small errors between these result points.

When we calculate intermediate member results (moments, shears, stresses, and displacements) each member is broken into sections. Each section requires equilibrium calculations and computer memory. More sections yield smoother, more precise results but also require more time and computer memory. An ideal solution balances computer resources and accuracy.

By default, VisualAnalysis will automatically adjust the number of member result sections based on the size of your model and the types of loads on a given member in each load case. This will give you the best results for small projects and reasonable results for large projects.

The number of result sections is independent of how you report your results or see them graphically. For display, we interpolate linearly between the calculated results positions and the reported positions. Although you can sometimes "miss" critical results by reporting too few positions along a member, you will never improve your results by reporting them at more places than were calculated! Some result tables will automatically search the calculated results to find extreme values for you.

## Set Member Result Sections

Use **Project Settings, Performance** to adjust how VisualAnalysis will create member result sections. This setting will also affect the accuracy of area loads distributed to members, which are calculated using numerical integration. Here are the choices available:

### **Setting**    **Description**

<b>Automatic</b>	Internally adjusts number of member result sections based on the model size. <i>This is the default setting.</i>
<b>Academic</b>	Uses a large number of member result sections to get very accurate results and smooth diagrams. This is the slowest performance setting.
<b>Normal</b>	Provides a dynamic balance between accuracy and computer resources. Good for most real-world projects.
<b>Fast</b>	Reduces the number of result sections down to a minimum for best performance. Intermediate results will be crude and you may miss peak moments if they do not fall near the center of members or if you have concentrated loads. Sometimes necessary for very large projects.
<b>Custom</b>	You decide how many sections to use for member results. There are four settings depending on the types of loads on a member in each load case. You should specify odd numbers to get a result point at the center. The minimum value is 3: end points and midpoint results only.

## Minimize Plate Element Sizes

Plate elements are approximate. To get good results you will need to use a mesh of elements. To know if you have good results, you will need to run multiple models, with successively more elements and then compare these results to see if the results are converging on the "true" solution. (Remember, the theory tells us that as we make the plates smaller and smaller, we will converge if we have a converging element, something VisualAnalysis has.)

The best approach, from a performance standpoint, is to start with some minimum number of plate elements. Use just enough to model the geometry of your structure. Then work from this point. Use the **Structure | Split Plates** feature to refine the model after loads are applied. When successive refinements give the same results (displacements, forces, etc.) as the last iteration, the plate mesh is probably adequate.

Auto-meshed plates are generated automatically based on the **Project Settings, Auto-Mesh Factor**, and you can set a desired plate count on individual Areas for more fine-grained control. With complex areas and connectivity constraints with other members and plates, a model with lots of meshed areas can generate lots of plates and become somewhat insensitive to your "requests" for number of plates.

## Control Dynamic Mass Distribution

In a static analysis, member behavior is exact. In a dynamic analysis a member's mass is lumped at its nodes. In order to get the best dynamic results, you might consider splitting members into multiple pieces. However, the more elements you have the slower the performance.

You might use a trial and error procedure starting with single members, analyzing, splitting, and re-analyzing to compare results. Repeat this process until you are comfortable that the results are converging toward the real-world system of distributed mass.

## 4.6 Static Analysis

VisualAnalysis supports three methods for static analysis: First Order, P-Delta, and AISC Direct. The Static Method is defined in the Analysis section of the [Project Settings](#) settings in the [Project Manager | Modify](#) tab.

**⚠** It is important to always validate the analysis results to ensure that the model is producing reasonable results. VisualAnalysis provides the Statics Check and the Result Check tools to help validate the analysis results.

### First Order Analysis

#### 1st Order Analysis (Linear Model)

A first-order analysis is linear and equilibrium is based on undeformed geometry. Since a first-order analysis is linear, the principle of superposition is valid for the analysis results. Often it is best start with a first-order analysis to ensure that a model is stable prior to performing a more advanced second order analysis.

#### Iterated First Order (Nonlinear model)

Models that contain one-way members or springs, cable elements, or semi-rigid connections are [nonlinear](#). The principle of superposition is not valid for nonlinear models and should not be used. For nonlinear models, the solution is iterative.

### P-Delta Analysis

The equilibrium of a deformed bending element that is also subjected to axial force, reveals a nonlinear contribution to the element's internal moment from the axial force times the displacement (P-Delta).

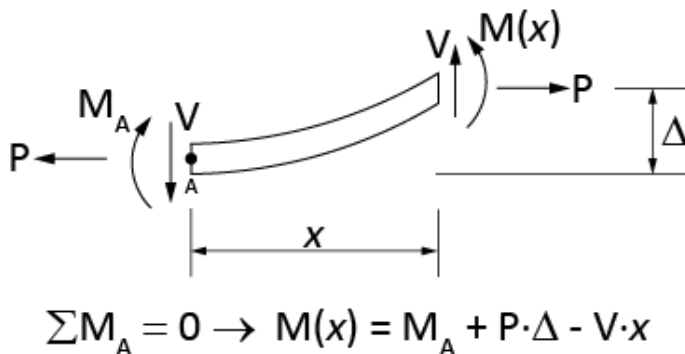

The term "geometric stiffness" is used to describe changes in stiffness due to enforcing equilibrium on the deformed geometry. Structural engineering FEA programs, like VisualAnalysis, typically include geometric stiffness by developing a separate stiffness matrix that is derived from the deformed element's equilibrium. Including geometric stiffness makes the solution process iterative since internal axial forces are not initially known. However, node positions are not updated during each iteration. Large displacement problems are beyond the scope of this type of analysis.<sup>1</sup>

When an element is in compression, the geometric stiffness can subtract enough from the linear stiffness that the element becomes unstable. In this situation, the analysis will fail to converge, and the buckled members are identified in the analysis details.

Including geometric stiffness captures P-Δ behavior. To include P-δ effects member elements need to be subdivided.

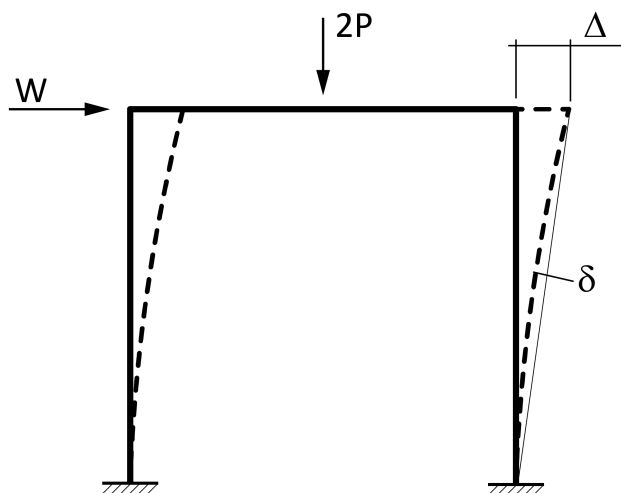

In VisualAnalysis, geometric stiffness can be included for member and plate elements. To include geometric stiffness in the analysis, select P-Delta as the Static Method in the Project Settings. Geometric stiffness is also included in the Direct Analysis Method. The First Order method neglects the interaction between axial load and bending stiffness. Cable elements derive all their flexural stiffness from geometric stiffness, as such geometric stiffness is included for cables regardless of the project's Static Method.

## AISC Direct

According to the [AISC 360 Specification](#), the Direct Analysis Method can be used to account for the stability of structural elements and for the structure as a whole. In VisualAnalysis, setting the Static Analysis method to AISC Direct results in a P-Delta analysis (see the previous section), with notional loads and a reduction in member stiffness.

Notional loads are automatically applied to each node of the model. A separate load combination is created for both horizontal directions. These additional load combinations can significantly increase analysis time. The sign of each notional load follows the sign of the load already applied to that degree of freedom. That is, if a node is already being pushed in the positive X direction, the notional load will push it further in that direction. Notional loads are only generated for Strength Level load combinations. While notional loads cannot be viewed in the model directly, their effects can be validated by reviewing the analysis results.

VisualAnalysis automatically reduces the flexural and axial stiffness of member elements as required by the specification. Reductions are a function of the internal axial force in each member. Since these axial forces are not initially known, calculating reductions is an iterative process.

The effective length factor,  $K$ , is set to 1.0 for member design when using the Direct Analysis Method.  $K$  can be overridden for each design group if desired.

## Unconverged Results

In any situation where a non-linear analysis fails to converge, you can investigate the issue by returning un-converged results (see the project settings). Un-converged results are solutions with reduced loading. While these results are not useful for design, they can help identify an unstable mechanism or the critical load that causes an element to buckle.

## Second Order Analysis Report Tables

The Diaphragm Drift Results report includes the ratio of second order to first order drift in each of the global in-plane directions for each diaphragm level in the structure. The report includes the node and second order drift for the location

where the maximum 2nd-Order/1st-Order ratio value is listed.

The Member Moment Magnification table lists the 2nd-Order and 1st-Order moments for each member and the ratio of 2nd-Order/1st-Order moments. The result case where the largest ratio occurred is also indicated in parenthesis, keyed to a Result Cases table that may also be included in the report.

## Assumptions & Limitations

- Materials are assumed to be linear, elastic, and isotropic (i.e. yielding, cracking, crushing, etc. are not considered)
- VisualAnalysis does not support large displacement problems
- Geometric stiffness is included for Cables Elements regardless of the project's Static Method.

## Approximations in Static Analysis

When modeling with Plate Elements it is important to recognize that the results are approximate and a mesh refinement must be performed until the results converge to get an accurate solution. For more information, see the [Plate Elements](#) section.

## References

1. Robert D. Cook. [Concepts and Applications of Finite Element Analysis](#). 4th Edition. Chapter 18. (2001) ISBN 978-0471356059

## 4.7 Dynamic Analysis

A **modal analysis** is used to determine the fundamental frequencies of vibration for a structure. This can be useful for isolating vibration problems due to machinery, human activity or seismic events. A **response analysis** is a simplified way to estimate seismic or similar dynamic effects using modal-superposition. The **time-history** response of a structure is most simply the response (motion or force) of the structure evaluated as a function of time including inertial effects.

Member elements are **approximate** for dynamic analysis, unlike a static first-order analysis. Splitting members into multiple pieces may provide more accurate mode shapes, due to better mass distribution, especially if you are investigating a very small model.

VisualAnalysis advanced provides **design-checks** for dynamic analysis results through [Result Superposition Combinations](#).

### Mass vs. Weight

The weight (or mass) of your model is less than the weight of the real structure--and that extra weight is critical for modeling. Weight is the effect of gravity on the mass. In a dynamic analysis the mass of the structure moves in any direction, so it is the inertial effects on that mass that we are analyzing.

In a dynamic analysis you need to model both the stiffness and the mass of the structure correctly. The modal analysis calculates **undamped frequencies** and mode shapes for the structure. Lumped mass properties are used in the analysis, which comes from three sources:

1. **Mass associated with the structural members and plates.** Included automatically based on material density and element sizes. This mass is lumped at the nodes, except for tapered members, where a consistent mass matrix is used.
2. **Additional mass you include at each node.** You should apply concentrated masses at the nodes to account for any mass not associated with the structural elements themselves. Rotational mass should be applied where there exist nonstructural entities that are affixed to the structure and have appreciable rotational inertia.
3. **Additional mass you include through a static load case.** The load case and global direction are specified in the

Mode Shape Case.

The sum of this mass for the structure can be included in a report. You should check this total to make sure that you have accounted for all the mass in the structure.

Reports generated for a dynamic modal analysis provide the nodal displacements for each mode shape. These displacements are not "real" values but rather shape displacements resulting from the modal solution. Mode shape values in VisualAnalysis reports are based on normalization to a unit mass matrix, in other words, the value  $\sum(M_i \times D_i^2) = 1$ , where:

$M_i$  = mass associated with degree of freedom  $i$ ,  $D_i$  = modal displacement associated with degree of freedom  $i$ . The sum is carried out for all degrees of freedom in the structure. Frequency, period, and modal weight participation factors (for each direction) are shown in the title bar of each mode shape **Result View**.

## **Mode Shapes**

Mode shapes are generated through a **Mode Shape Case**. Create these using the **Dynamic Cases** tab of **Load Case Manager**.

You will need to consider how many mode shapes are necessary. Theoretically, there is one mode shape for each degree of freedom in your model. Generally only the first few in each direction are really important. Still, you may need to generate many mode shapes to obtain a few in each direction. VisualAnalysis extracts the lowest frequencies (largest periods) from the frequency spectrum, unless you specify a minimum frequency.

VisualAnalysis uses a Sparse Lanczos procedure which has proven to be very robust.

## **Find Dynamic Response**

Use the **Load Case Manager** to create a **Dynamic Response Case**. The load case does not use any loads, but relies on results from a Mode Shape Case, which is a set of mode shapes.

**Modal weight participation factors** are normally checked to see if enough mode shapes have been included in a response spectrum analysis. Building codes usually require a percentage (like 90%) of all the modal weight to be accounted for when performing a modal superposition analysis. These are calculated for all translational directions in the model. For a discussion of the effective modal weight calculation, see the following reference.

Response Spectrum Analysis is based on modal superposition. Results from a modal superposition analysis are all non-negative numbers. This includes displacements, forces, and stresses. The analysis will also calculate a total base shear. You may select from the CQC method, or the old SRSS method:

### **CQC Method**

This commonly used method allows specification of a uniform modal damping factor. This method and the combination equation are outlined in the following reference:

Mario Paz & William Leigh *Structural Dynamics Theory and Computation*, Springer, 5th Ed. 2006  
ISBN: 978-1402076671.

<b>Symbol</b>	<b>Definition</b>
U	Response (force, moment, translations, etc.)
$U_{iXX}$	Response in $i$ th mode, X earthquake direction, X spectrum input
$U_{iXY}$	Response in $i$ th mode, X earthquake direction, Y spectrum input
...	...
$U_{iZZ}$	Response in $i$ th mode, Z earthquake direction, Z spectrum input

### **SRSS Method (Square Root of the Sum of the Squares)**

All sums are sums of absolute values.

$$U_{IIX} = \sqrt{U_{1IX}^2 + U_{2IX}^2 + U_{3IX}^2 + \dots + U_{NIX}^2}, \text{ where } N = \text{Number of Modes}$$

## 4.8 Time History Analysis

### Requires: Advanced Level

The Time History response of a structure is simply the response (motion or force) of the structure evaluated as a function of time including inertial effects. The time history analysis in the **advanced** level of VisualAnalysis allows four main loading types. These include base accelerations, base displacements, factored forcing functions, and harmonically varying force input.

### Harmonic Forcing Function

The harmonic forcing function varies in a sinusoidal fashion and requires  $A_0$  and  $\omega$  to be specified. The equation takes on the form  $A(t) = A_0 \sin(\omega \cdot t)$  and  $A(t)$  multiplies all static loads placed in the time history load case at various times. Harmonically varying loads are probably most common when analyzing the effects of machinery on a structure. Often unbalanced rotating machinery or parts are most applicable. Note that the units on  $\omega$  are such that  $\omega \cdot t$  has angle units of radians.

### Factored Forcing Functions (Load Amplitude)

The Load Amplitude time history option essentially uses a text file to specify the fraction of the load at specific times. The text file requires two columns, time (t) and A(t) which is the amplification factor. Shown below is a sample of what would appear in the text file along with a plot of the data. Note the text "Force" on the first line. When this text file is read into VisualAnalysis the first line indicates the type of data.

---

```
Force
0.0          0.0
0.05         1.0
0.1          1.0
0.1001  0.0
9.0          0.0
```

---

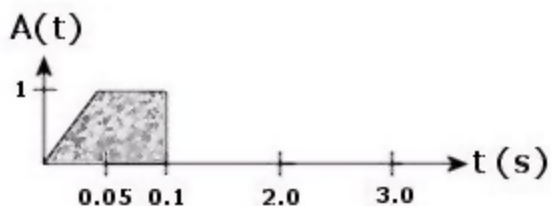

As with the harmonic function,  $A(t)$  multiplies the static loads applied to the structure in the time history load case at various times. Load Amplitude loads are commonly used to model wind loads, impact loads, and possibly blast loadings.

### Base Displacement

Like the Load Amplitude loading type, the Base Displacement uses a text file for input. The base displacement is exactly as it sounds, the structure is forced through some varying ground displacement over time. These displacements can act independently in the global X, Y, and Z directions. The displacements can be any combination of all or some of these directions. (I.e. If you wanted to model an event at a 45 degree angle to the X and Y directions you could specify the

# VisualAnalysis 19 User's Guide

necessary components in the X and Y directions respectively.) Units for the text file are always assumed to be seconds and inches. After the file is read in the data will be converted to the current unit system. For example, if one of the displacement values was 6 in it would be read in as 0.5 ft if your current project units were lb-ft. The text file requires at least two columns and can have up to four (refer to the Text File Notes section below for more information). These columns would be the time,  $t$ ,  $u_x(t)$ ,  $u_y(t)$ , and  $u_z(t)$ .

---

Displacement			
0.0	0.0	0.0	0.0
1.0	5.0	0.0	0.0
2.0	-5.0	0.0	0.0
3.0	5.0	0.0	0.0

---

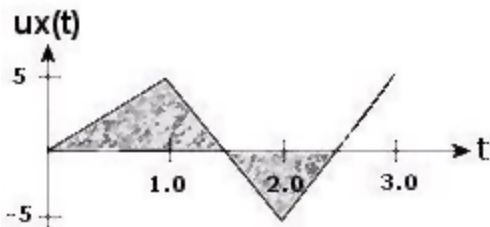

Note that the line is extrapolated linearly between the  $t = 2.0$ s and  $t = 3.0$ s values but our time increments limit the displacement to 2.5 seconds. In the example the  $u_y(t)$  and  $u_z(t)$  columns are included but have no effect. Note also that if you are working in a plane structure the  $u_z(t)$  column will always be ignored.

## Base Acceleration

Again, the Base Acceleration loading type uses a text file for input. The base acceleration is very similar to the base displacement and represents putting the structure through some varying ground acceleration over time. Logically, the base acceleration is just the second derivatives of the base displacements. Similarly, the accelerations can act in the x, y, and z directions and again they can be any combination of all or some of these directions. The text file requires at least two columns and can have up to four (refer to the Text File Notes section below for more information). These columns would be time ( $t$ ),  $\ddot{u}_x(t)$ ,  $\ddot{u}_y(t)$ , and  $\ddot{u}_z(t)$  where the accelerations are specified as a decimal fraction of G (i.e. "0.5" would be 50% of G). Note below the text file is shown in a space delimited format.

---

Acceleration			
0.0	0.0	0.0	0.0
1.0	1.0	0.0	0.0
2.0	0.0	0.0	0.0
2.01	0.0	0.0	0.0
3.0	0.0	0.0	0.0

---

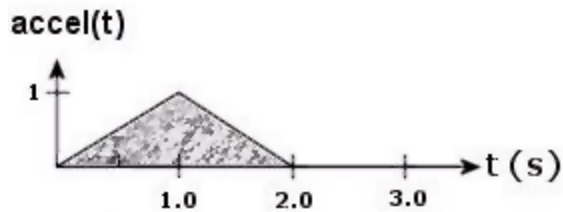

## Base Displacement and Base Acceleration Notes



With the base displacement and base acceleration analysis types static loads only have an inertial effect on the structure. With the harmonic and amplitude analysis types, the static loads applied within the time history case are varied dynamically according to what is specified. For the displacement and acceleration types, VisualAnalysis converts any statically applied load in the time history load case acting in the positive or negative Y direction to a mass. It then has an inertial effect on the results similar to adding lumped mass to nodes. Any statically applied loads that do not act in the gravity direction (positive or negative Y) and any moments are simply ignored by VisualAnalysis and will have no effect on the displacement or acceleration analysis results.

## Text File Notes

Some general notes about the input text files. The text files can be comma, space, or tab delimited. The Force, Displacement, or Acceleration "headings" on the first line are not essential for the file to work but it is recommended.

Once the data file is opened and read successfully, the data is stored in your project file (\*.vap) and the connection to the data file is not maintained. If you edit or modify your data file, you would need to edit the Time History load case to re-load the data from the file. Storing the data file in the project file allows the project to be sent to a colleague or opened at some future time when the text file is not available or may have a different location.

Lastly, the values in the text files are always linearly interpolated until you set a new value. For example, in the sample acceleration data we wanted the acceleration to be zero at a time of 2 seconds and beyond. To accomplish this we specified an acceleration of zero at  $t = 2.0$  sec and also at  $t = 2.01$  sec. If we had not added the  $t = 2.01$  sec entry the program would simply have continued to interpolate a straight line between the acceleration of 1 at  $t = 1$  sec and zero at  $t = 2.0$  sec and continuing on past 2.0 seconds.

## Amplitude, Acceleration, and Displacement Input

In time history analysis procedures there are a number of ways to numerically integrate the fundamental equation of motion. Many of these are discussed in text books including the referenced texts included in this document. VisualAnalysis uses the Newmark method of numerical integration which is considered a generalization of the linear acceleration method. The parameters of the Newmark method are described in what follows.

Number of Steps – This is the number of time steps over which you wish to analyze.

Delta t – This is the time increment for each step. The time step increment can be very important as well. E.L. Wilson in [3] recommends  $\Delta t \leq 1/(\omega_{MAX} * \sqrt{\gamma/2 - \beta})$ . For large multi degree of freedom structural systems there is a different limit. This due to computer models of large real structures normally containing a large number of periods which are smaller than the integration time step; therefore, it is essential that one select a numerical integration method that is unconditional for all time steps. For a further discussion refer to [1], [3], and [4].

Gamma and Beta – The Newmark method is basically considered a generalization of the linear acceleration method (Wilson-Theta). Gamma and Beta replaced the 1/2 and 1/6 coefficients on the incremental acceleration terms of the equation for incremental displacement, as derived by the Wilson-theta method. E.L. Wilson presents a good discussion in [3] regarding the beta and gamma parameters for Newmark's method. Many text books on the subject also describe these parameters. The default values of gamma = 1/2 and beta = 1/4 may be used unless you are sure otherwise. These default values make the Newmark method unconditionally stable and provide satisfactory accuracy. Using other values, particularly gamma greater than 1/2 can lead to "numerical damping" and "period elongation".

Delta – Stiffness-proportional damping factor. The Damping Matrix, C, is defined as:  $C = \text{delta} * K$ . [3]

## Time History Results

The unique characteristic of time history cases is you can view results for every time step. A very useful way to look at results is to use the graph feature. For example, while in a Result View you can right click a node in your time history case and select "Graph Node Results" from the context menu. This will allow you to plot displacement, forces, and moments over time for the selected node.

## Time History Reports

There are three main report items available for time history load cases: Time History Cases, Forcing Function Details, and Forcing Function Summary. The Time History Cases item includes a number of items with the most common ones being the number of time steps, time step increment, gamma, beta, and delta values, and the forcing type. The Forcing Function Details and Forcing Function Summary report items are very similar. They both include the time history case name, the forcing type, the location of the source text file that was used (if applicable) and the number of data points. The only extra information the Forcing Function Details report gives is the data that was read in from the text file in a tabled format. Note that many of the static reports are available at a specific time increment in a time history analysis. For example, you can view member internal forces at any of the time increments during the analysis. Also, the use of enveloped results becomes very useful for processing time history results. Logically, using an envelope would quickly allow you to see the overall maximum and minimum extremes for just the time history case or for multiple load cases. Refer to the Enveloped Results section for more information.

## References

1. Paz, Mario, and William E. Leigh. *Structural Dynamics: Theory and Computation*. 5th ed., Kluwer Academic Publishers, 2006. ISBN 978-1402076671
2. Weaver, William, and Paul R. Johnston. *Structural Dynamics by Finite Elements*. Prentice-Hall, 1987. ISBN 0-13-853508-6.
3. Wilson, Edward L., *Three-Dimensional Static and Dynamic Analysis of Structures: A Physical Approach with Emphasis on Earthquake Engineering*.  
Chapter 20: Dynamic Analysis by Direct Integration  
[www.edwilson.org/book/book.htm](http://www.edwilson.org/book/book.htm)
4. Wilson, Edward L., and Ray W. Clough. "Dynamic Response By Step-by-Step Matrix Analysis."  
[www.edwilson.org/History/Dynamic Analysis by Step-by-Step Integration.pdf](http://www.edwilson.org/History/Dynamic%20Analysis%20by%20Step-by-Step%20Integration.pdf)
5. Wilson, Edward L., *Three-Dimensional Static and Dynamic Analysis of Structures: A Physical Approach with Emphasis on Earthquake Engineering*.  
Chapter 17: Seismic Analysis Modeling to Satisfy Building Codes  
[www.edwilson.org/book/book.htm](http://www.edwilson.org/book/book.htm)

## 4.9 Result Superposition

**Requires: Advanced Level**

### What is a Result Superposition?

VisualAnalysis has the ability to superimpose the analysis results to create a post-analysis load combination. This is useful for combining loads that cannot be combined before analysis. You will want to use this feature to combine static and **dynamic** results or to combine results from **moving loads** with other static results. This type of combination will generally consist of an envelope pair (extreme minimum and extreme maximum) results, depending on whether any of the results you include are 'extreme only' results. The extreme only result cases include the time-history envelope results, and the moving load case results.

The superposition is carried using simple algebraic summing of like results from each result case. There is no special logic or intelligence in the process. When an envelope is included, the normal results from simple result cases are added to both the extreme minimums and the extreme maximums.

### How to Use

To access this feature use the **Load Case Manager, Advanced** tab, and select which possible result items to include. You

can create this combination before you have analysis results. After analysis this combination will only contain results if all of the included result-sources actually exist.

Superposition combinations may be marked as a **design** load combination (ASD, LRFD, or deflection). This is the approach to take to get [design checks](#) for [moving load results](#) or for [dynamic response](#) or [time history](#) results.

When viewing **Result Views** showing any envelope results, use the **Filter** tab in **Project Manager** to toggle between the *High Extremes* and the *Low Extremes*.

## Limitations & Details

This feature is not available if the model is nonlinear. Superposition does not apply to nonlinear analysis, so adding result cases makes no sense. For example, if a tension-only member is removed from an analysis because it goes into tension, how can you add the results from another analysis where this member may not be in tension? *VisualAnalysis* does not allow the combination of results that could be combined before analysis, you should use the other types of load combinations for combining static loads, for example.

*VisualAnalysis* allows you to combine P-Delta (2nd order analysis) results, however it will warn you that doing so is really not valid. P-Delta analysis is nonlinear, so using superposition on the results may yield incorrect results. From a practical standpoint, it may not make a big difference, as P-Delta results are usually within 10% of the linear results, yet you may be adding 'apples' with 'oranges'! Please exercise caution and double-check the answers you get.

Dynamic Response result cases contain only absolute values. When a Dynamic Response is combined with any other result cases, these positive values are added blindly during the superposition—that is, there is no intelligence in the process to determine a 'worst case' superposition. These positive values are added to both envelope extremes, if the superposition is an envelope.

Envelope result 'locations' are not retained or calculated in the superposition combination. You will not be able to determine from a result superposition where a moving load was, or the time step from a dynamic time history analysis.

## 4.10 Envelope Results

**Requires: Advanced Level**

### Envelope Feature

Located on the **Advanced** tab of the **Load Case Manager**. **You do not need this feature to find extreme results!** Reports can locate extremes and design-checks do it automatically! This feature allows extremes to be calculated and stored for time-history results, moving load and superposition combinations.

### Viewing and Reporting the Envelopes

As mentioned above, the process to obtain an envelope is essentially automatic. To view the resulting envelope there are a couple of options. Just like other load cases or combinations, the Envelope Results show up on in a Result View. Use the [Command Bar](#) at the top of the Result View to select one of the Envelope Cases to display. On the **Filter** Tab of the **Project Manager** under the **Results Display** heading use **Envelope Type** to control which set of results "*Low Extreme*" or "*High Extreme*" to display. Note that these are the upper and lower extremes and it is very possible for your largest moment to be negative and occur in the minimums case.

### Envelope Moment Diagrams

The first option for viewing the envelope is graphically. As with other load cases you can select a member, then **right-click** and choose **Graph Member** from the context menu. This will typically default to a plot of the deflection, shear, and bending moment for the member but can be customized to include or exclude items. The Member Graph shows both the

maximum (High Extreme) and minimum (Low Extreme) for the envelope. The Low Extreme is defined by the boundary with a lower magnitude while the High Extreme forms the boundary with the higher magnitude (absolute value). Viewing the results of a simple cantilever beam and comparing them to the Member graph will help clarify exactly what is being displayed. You may notice that the plots typically have sharp changes or steps in them usually indicating where a different load case has begun to control.

## Envelope Reports

The other way to view the resulting envelope is with typical reports. The reports are very similar to member reports in other load cases. You can view Member Internal Forces, Local Displacements, and other items. As usual you have the option of viewing just the extreme results (i.e. the extreme results of the envelope) or you can view a detailed table of all the results along an element.

Note: Envelope results are calculated at **discrete places** along the length of the member. The high and low extreme values at each location may come from completely **different load cases**, therefore VisualAnalysis will not linearly interpolate between the result-locations to produce a "summary" report, or a report showing more or fewer offsets than were calculated internally.. The moment diagrams are not smoothed and you may see jumps or spikes in the values that for normal results you would not expect to see! To control the number of places where envelope results are calculated, set the values in **Project Settings, Performance** to some upper limit.

## 5 Design

### 5.1 How To

#### 5.1.1 The Design Process

##### Requires: 2D Design Level

This topic is a 30,000 foot look at "how" you do design in VisualAnalysis. It assumes you familiar with the [essential design concepts](#). The outline is the same whether you are designing with members or a plate mesh (concrete slab), the terminology changes from 'Group' to 'Mesh' for slab design.

**Prerequisites:** [Setup Load Combinations](#) and get "reasonable" [Analysis Results!](#)

### Design Operations

- [Finding Design Features](#): menus, windows, and more related to design
- [Modeling for Design](#): Things to consider before constructing your model
- [Loading for Design](#): How to set up loads for efficient design checks
- [Analyzing for Design](#): Things to consider before you start designing

### Design Procedure

1. [Switch to Design View](#)
2. [Adjust Design Parameters](#)
3. [View Unity Checks](#)
4. [Design the Groups](#)
5. [Synchronize Design Changes](#)
6. [Iterate As Necessary](#)
7. [Create Design Reports](#)

#### 1. Switch to Design View

The first step in the actual design process is getting a Design View. This window looks much like a Model View, but has a Filter, context menu, and design legend that will help you work with design groups.

#### 2. Adjust Design Parameters

VisualAnalysis will normally automatically create [design groups](#) according to how the members are oriented in the model view, based on the setting in the [Project Settings](#) section in Project Manager. You may wish to take charge of this with manual groups. Once groups are defined to your liking you need to enter appropriate [design parameters](#) for each group (bracing, deflections, size constraints, etc.). Use the **Modify** tab after selecting one or more members or groups.

If you set up design parameters when there are **no analysis results**, the unity checks will not recalculate with every change. This can be far more efficient!

#### 3. View Unity Checks

Unity check results are calculated and displayed automatically in the Design View if analysis results are available when you switch to this view type. Unity checks may have a prefix (~ = approximate), or a suffix (! = warning; !! = error) see the **Help**

**Pane** or design report to understand warnings or errors.

## Why is the Member Red or Failing?

In a Design View, **double-click** on a member or plate to see a design report. Alternately include a **Design Member Results** item into any other report.

## 4. Design the Group

To search for optimal member shapes or slab details, you may select any one or more elements in a group and choose **Design the Group** command. The software will search for a least-weight design and present you with some options. Available options may be limited by size constraints in the parameters. You may experiment with different shape profiles, or parametric sizes to really optimize the member for the demands.

Your design member shapes are approximate! That is, your analysis-model has not changed and the member forces used were based on analysis using different member stiffnesses! Note that optimization is per-member, not per-model. As you change members, the demands on members may shift around your model due to relative stiffnesses. This may cause other previously designed members to fail again! VisualAnalysis does not currently offer a structure-wide optimization.

## 5. Synchronize Design Changes

Changes are not official until you use the **Design | Synchronize Design Changes** command. This is available so you can work through all of your design groups without losing the analysis results due to design changes.

To verify that your design selections really do satisfy all the requirements you will need to synchronize the changes or rerun the analysis.

## 6. Iterate As Necessary

Whenever you change the relative stiffness of elements in your model, you may also change the moment distribution. Thus, unity checks are made using forces calculated on a different model and are flagged as approximate. A tilde (~) in front of unity checks to indicates the checks are approximate, based on results from a previous version of the model.

After you synchronize and reanalyze the model, the design groups are rechecked. If all the members in the group are the same shape, and all the members have unity checks less than one, then the group is considered as having a good design.

## 7. Create Design Reports

The **Find Tool** window and **Report View** offer a number of ways to view the design check results. If you want to really understand the unity-check value displayed, simply **double-click** on a member in the **Design View**.

## 5.1.2 Loading For Design

**Requires: 2D Design Level**

### Setting Up Load Combinations

The design software checks only the load **combinations** you define in [Load Case Manager](#), no other types of load cases are used by the design software. You may define any number of load combinations to check, using automatic building code combinations or your own custom load combinations. Each load combination is assigned to one of the following design categories:

- **No Design:** The load combination is ignored in all design checks.
- **Allowable (ASD):** Used for force or stress checks at service level.
- **Strength (LRFD):** Used for force or stress checks at ultimate strength level.
- **Deflection:** Used to check deflections. Note that deflection combinations fall into one of four IBC-defined categories based on the types of loads they contain:
  - 'L Only': A combination for **just live loads**
  - 'L + D': A combination of dead and live loads, **but nothing else**.
  - 'W or S': Any combination including wind, snow or both types of loads (and any other types).
  - 'Other': Anything load combination that does not match one of the above.
- **Allowable & Deflection:** Used for force checks and deflection checks.

## Matching Load Combinations to Design Groups

The type of load combinations you use depends on the type of materials or design groups you are using. The following table shows how the type of group maps to load combination checks. When design groups are initially created the type of load combination is chosen based on 'current' definitions in Load Case Manager. If you later change the material specification for design from ASD to LRFD you may also need to go back to Load Case Manager and add or change appropriate load combinations.

<b>Design Group Type</b>	<b>Strength or Allowable Load Combination Type</b>
AISC, CISC Steel	Either, select the specification in the design parameters
NAS Cold-formed Steel	Either, select the specification in the design parameters
ACI Concrete	Strength (LRFD) only.
NDS Wood	Either, select the specification in the design parameters
ADM Aluminum	Either, select the specification in the design parameters
Connections ( <b>VACONNECT</b> )	Strength (LRFD) only

## Live Load Reduction

It is possible to check design groups for specific live load reduction levels. The process is two-fold. First use the load case manager to define the live load reduction levels that you wish to use. Note that additional load combinations are generated for each level, which has a significant performance impact. The second step is to specify that a design group should be checked for one of these live load reduction levels. That design group will then ignore the full live load combinations and load combinations for other reduction levels.

## Checking Results Superposition

VisualAnalysis has the ability to run design checks on superposition result combinations. These are advanced features for combining moving load or dynamic results with more traditional static analysis results. The superposition consists of two sets of results culled from many results instances or times: upper and lower extremes. We currently design-check each of these independently, and while this may provide more information to the design algorithms and catch situations that might control the design, it may very well miss certain combinations of forces that would control.

<b>Results</b>	<b>Checked?</b>
+Fx, +Mz, +My	<b>Yes</b>
-Fx, +Mz, +My	No

## Results

+Fx, -Mz, -My

-Fx, -Mz, -My

## Checked?

No

Yes

For example, we will check the maximum axial force (e.g. tension) in a member with the maximum moment. We will check the minimum axial force (e.g. compression) in a member with the minimum moment. But 'cross-over' checks are not currently made, and depending on the shape, material used, bracing, magnitudes of forces, etc., other combinations may actually control the design! So VisualAnalysis could be quite unconservative in this regard!

## 5.1.3 Modeling For Design

**Requires: 2D Design Level**

### Members Elements vs. Combined Members

As you create models in VisualAnalysis, you should be aware of the design ramifications. In most cases, you will model a beam as a single member element. With girders, columns, and other types of frame elements, may choose to use multiple member elements, for some reason. The normal approach would be to draw in the full-length of the member and use the Connect Crossings feature to insure that the FEA model is split, but the member used for design checks is the full length. This introduces a complexity in design, especially for bracing.

The design software looks primarily at your member, not the FEA (split) member elements. If you split members up at crossing points, you may need to adjust the design options for span length, bracing, deflection limits, and other parameters.

### Pick Good Preliminary Sizes

Design is usually an iterative process. As you make design changes you change the stiffness and therefore the moment distribution in your model, causing the design checks to become invalid. By selecting reasonable preliminary sizes before you run the design software you can save time.

### **Size Constraints**

The design software allows you to limit the depth of beams, or the size of columns using Size Constraints. This can have two benefits: The software will not 'design' members that fall outside of these boundaries (or will warn you if you model members outside these boundaries). This can also dramatically reduce the "design" performance when searching for a size that works, because many shapes in the database can be skipped! *Note that setting beam width constraint is only available in the 'Advanced' level of VisualAnalysis.*

### Design Tapered Members?

Although tapered members are supported in VisualAnalysis for analysis, there is very limited 'design' support for them. If you attempt to design a tapered member, you will get unpredictable results. At best, the member will be sized as a prismatic member; at worst, you will get garbage design results. You will see a message in the Design View "tips" to indicate this condition.

### Plate Design Limitations

The only support for plate element design is in the concrete wall/slab component.

If you are looking for design help with circular structures, or in materials other than concrete, you will not find it in VisualAnalysis—yet. For these types of problems, you will be able to get analysis results (stresses, deflections) and then



you may perform your design manually or with non-IES tools (such as a spreadsheet) using this information.

## 5.1.4 Analyze For Design

### Requires: 2D Design Level

There are a number of considerations you should weigh carefully when deciding what to analyze and what options to use before you begin or complete your design. For example, AISC Direct Analysis does not work for ASD design checks.

### Accuracy vs. Performance

#### Approximations

VisualAnalysis is an approximate, numerical tool for analysis. It uses the finite element method to calculate displacements and forces. The accuracy of the analysis is only as accurate as your model, and even then there are some approximations and simplifications made. There is no concept of 'load path' in a finite element analysis.

For example, member internal forces are calculated at discrete points along the member. If the moment varies in a nonlinear fashion and the number of calculation points is small, peak moments may be missed.

#### Control

VisualAnalysis lets you control the number of places along members where results are calculated. If you increase these numbers your results will be more precise whereas if you decrease them you will get better performance from the software. VisualAnalysis by default will do a fairly good job of adjusting these values based on the size of your project. If you want to control it yourself, use [Tools | Performance vs. Accuracy](#).

#### Performance Tip

If you have many load cases or many members, design checks can be relatively slow. You may wish to operate in a preliminary design mode for a while, using just a few key load combinations, or adjusting the [performance settings](#) to **Fast** until you have essentially completed your design. At that point you can change the [load case settings](#) or adjust the performance settings in order to get the most accurate results and design.

### Inspect Your Results Carefully

Before design checks are made, you should carefully check the analysis results you have received from VisualAnalysis. If you have large displacements or rotations, running the design software may yield equally erroneous results. The software is all based on "small deflection theory"; so large results are usually garbage results!

In some cases you will see reasonable displacements, but member stresses may be larger than yield stresses for the materials. In other cases, buckling loads may have been exceeded, and for a first-order linear analysis they are not detected or flagged during analysis. This condition will likely be "caught" by the design checks, but you might more efficiently correct this problem in the model.

All member forces checked and reported in *VisualAnalysis* are with respect to the member element's local axes

It is recommended that you use the [Tools | Result Check](#) command before starting the design process.

### Analyzing Non-Design Load Cases

Load combinations that are not marked for design checks are simply ignored by the design software. Look at [Load Case Manager](#) on the [Combinations](#) tab for design settings. Service load cases are never checked for design.

# VisualAnalysis 19 User's Guide

In certain situations individual load cases will not analyze because they are unstable on their own. This will happen for example if you have an 'overturning' load case which is unstable when analyzed separately from the self-weight of the structure. By not analyzing load cases that are not required for design, you can improve the performance of the software and reduce unnecessary report output.

## [Frame Instability Analysis](#)

Some of the design modules, like LRFD steel, expect that you have performed a frame-instability or second order (P-Delta) analysis. The AISC Direct Analysis Method is also an option.

If you run only a first order analysis and the design software is expecting a second order analysis, you will need to define an approximate moment-magnification "B" factor in the steel LRFD design modules.

## [Design for Dynamic Analysis](#)

*VisualAnalysis* will check results from a Result Superposition case. Dynamic Response analysis, Dynamic Time History analysis, moving load cases, and static load cases can be combined in a Result Superposition combination to produce "Envelope" results to be used for design. Because these are enveloped results, the Cb design parameter can not be calculated and is conservatively taken as 1. Also see notes here: [Loading For Design](#).

Another normal approach for doing seismic design is to come up with static seismic forces to apply in a Service Load Case using some method acceptable to your building code. For example, use the Dynamic Response Spectra analysis, and then take the reported base shears from that analysis and distribute them back into the structure for a static analysis.

## 5.1.5 Working in Design View

**Requires: 2D Design Level**

### [Accessing Design Features](#)

Most of the design commands are found in the **Design** tab of the main ribbon, which is visible only when the Design View is active. For convenience, frequently accessed commands are also located in the Design View's context menu, accessed by clicking the right mouse button.

To see a list of your Design Groups and basic unity checks, you can use the **Find Tool**.

 To find out why your **members are failing design checks**, **double-click** on the member and view the detailed design group results report.

### [Design View Window](#)

VisualAnalysis provides the framework to glue the various design components together. The focal point for design activity is the Design View. This window displays design information in much the same way as a Model View shows your model and loads, or a Result View shows analysis results.

The Design View will show you the names of your design groups, unity check values, final design shapes, and additional information regarding the status of the design process. The Project Manager Filter allows toggling the display of various items, including the Design Legend, unity checks, and span/deflection ratios. If you do not see the unity check values or colors displayed, you may change the Filter settings.

The Design View provides a context menu (right-click menu) for accessing design functions. There are also "Fly by" tips available. If you hold your mouse over an element, you should see a note with more information about the unity check for that element, including critical warnings or errors.

**Click** on a member to select that member and the design group it belongs to. If you **double-click** on a member or plate in the Design View, you will get a Design Report for that item, assuming that one is available. The **Del** key will delete selected design groups.

## Design Legend

The Design Legend explains the colors and line styles used to display the model in a Design View.

- **Not grouped.** This element has not been associated with any design group, it is shown in **blue**.
- **Not checked.** The element belongs to a group, but that group has no code checks or design results, it may be that no analysis results are available. This element is shown in **red** and has a N.A. label.
- **Failed.** The element is **in red** to indicate that unity checks failed. More information may be available in the Fly by tip, or in a Design Report.
- **Grouped and checked.** This element will be **shown in color**, where the color represents the unity check value. If the member is shown as a dashed line, this is an indication that there was a warning or error during the unity check. More information may be available in the Fly by tip, or in a Design Report.

## Design Commands

The **Design** tab in the main ribbon lists commands available for design groups and the design process.

### Design View Context Menu

The context menu, or **right-click** menu, for a Design View provides a concise custom-tailored menu for the current available options. You might consider this your first choice when searching for a relevant design command. The menu is dynamic, depending on what is selected, what is displayed, and what is in the model. All of the commands in this menu are also available in the main menu as well.

### Copy Group Properties (Format Painter)

VisualAnalysis allows you to "copy & paste" design group properties.

1. Select a member, use **Home | Copy**
2. Then select any other member elements before using **Home | Format Painter**.

You will be prompted to confirm you wish to copy the properties from one group to the other.

### Design Result Reports

Design reports provide details of the design checks, including intermediate values, a summary of your design requirements, actual load or deflection values checked, code or specification references for each controlling check, and an explanation of design errors or warnings. You can get a design report by **double-clicking** on an element in the **Design View**, or through **Add Tables** in the **Project Manager**, while viewing a **Report View**.

Design offers a variety of ways to report the results of design checks. The Design View shows a graphical summary of the unity checks as colors and values on elements. You can get the complete design report for an element by double-clicking on the element in the Design View.

## 5.2 Concepts

## 5.2.1 Groups

### What is a Design Group?

A Design Group in VisualAnalysis is simply a collection of member elements that are designed using the same set of Design Parameters. There are currently seven types of design groups in VisualAnalysis:

- [Aluminum](#)
- [Cold Formed Steel](#)
- [Concrete Beam](#)
- [Concrete Column](#)
- [Generic](#)
- [Steel](#)
- [Wood](#)

Each Design Group is assigned a design specification by the user (e.g. a steel design groups can be assigned AISC or CISI design specifications). Design Groups can significantly reduce the required amount of data entry and can simplify the design of a structure by grouping similar members together. Design checks are only performed on members that are in a Design Group and members can only belong to a single Design Group (e.g. Column A cannot belong to both Steel Design Group 1 and Steel Design Group 2). To design an individual member, simply place the member in its own Design Group. Members in a group are designed collectively and the resulting parameters (shape, size, etc.) will be the same for all members in the group. VisualAnalysis checks all the members in the group and verifies that the selected parameters for the group will satisfy the strength and serviceability requirements for all members. To obtain design results, members must have parameters that are consistent with the Design Group (e.g. a wood beam cannot be designed in a concrete beam Design Group, a member with a cold-formed shape cannot be designed in a steel Design Group, etc.).

### Auto-Groups

VisualAnalysis will automatically generate Design Groups when the Auto-Group Member feature is enabled in the Design Checks region of the **Project Manager | Modify** tab. Auto Groups are generated for members with similar shapes, materials, lengths, and orientations. Turn off the Auto-Group Member feature to manually control the grouping of members. Note that manually manipulating members in a group (such as removing a member) will automatically disable the auto-grouping feature.

### Manual Design Groups

Members can be manually added to or removed from a Design Group or new groups can be created using the buttons in the Design tab of the main ribbon (these features can also be accessed using the context menu in the Design View). As previously mentioned, manually manipulating members in a group (such as removing a member) will automatically disable the auto-grouping feature which can be re-enabled at any time. When grouping members manually, take into consideration the members' shapes, lengths, orientations, material properties, and how the members are braced.

### Member Selection

The Selection Mode in the **Project Manager | Design Filter** tab controls what happens when members are clicked on in the Design View. When set to "All in Group" clicking on one member in the Design View will cause all the members in the Design Group to be selected. When set to "Individual Element" clicking on one member in the Design View will cause only that individual member to be selected, which is particularly useful when removing members from a group. Modifying the parameters of an individual member in a Design Group that is selected still changes the parameters for the rest of the unselected members, since all the members within a Design Group share a single set of parameters.

## 5.2.2 Unity Checks

**Requires: 2D Design Level**

### Unity Checks

A unity check is simply the **ratio of the demand to the design capacity**. The unity check allows the user to quickly identify if the element is passing ( $\text{unity} \leq \text{Unity Success Limit}$ ) or failing ( $\text{unity} > \text{Unity Success Limit}$ ). The Unity Success Limit can be manually set in the preferences (e.g. setting the value to 1.02 will allow a slight overstress for the design checks before the program indicates a failure has occurred). The unity check can be a stress ratio, a force ratio, a deflection ratio, etc. All of the design load cases are checked for a member and the worst-case (largest value) for the unity check is displayed in the Design View or the Report View. The unity checks for a member vary base on the member type, material type, design specification, etc. Unity checks can also be viewed as a "**percent material utilization**" factor. Low unity check values (in the range of 0.01 to 0.25 for example) indicate that the elements are over-designed and there is a significant amount of wasted capacity. High unity check values (in the rage of 0.95 to 0.99 for example) indicate that the elements are optimized and the majority of the capacity is utilized.

Some design check produces unity checks with an arbitrary number greater than one. For example when concrete reinforcement detailing checks fail, the unity check value is set to 10.0. Unity check values, errors, and warnings are displayed in the **Design View** and the **Find Tool**. Hover over a member to see quick information in the Help pane or **double-click** a member in the Design View to get a detailed design report.

### Checks vs. Design

In VisualAnalysis, there is a distinction between checks and design:

**Checks:** The model is checked "as is" using the Design Group's parameters. Each member in a Design Group may be a different shape and is checked using its individual shape. Checks are automatically produced when the analysis results are available.

**Design:** Using the **Design the Group** or **Quick Design All** buttons in the **Design** ribbon to search for a shape that works for all members in the group; all members are checked using the chosen shape. Designing a group causes all the members in the group to take on the same final shape.

### Check Level

Each design group has a check-level setting that may be used to improve performance or to identify issues in a model.

- **To Failure:** The design checks stop as soon as a failure is detected. This is the fastest option but produces the least amount of information. If an early limit states fails, subsequent limit states will not be checked. For example, if shear fails, bending check may not be performed. It is possible that a more significant failure would have been identified if the checks had continued.
- **Each Limit State:** Checks each limit state even if a previous limit state failed. This level considers the controlling location and result case for each limit state and is appropriate for the majority of design scenarios.
- **All:** Every point along the member and every result case is checked and reported (no attempt is made to search for extremes during the design checks). This is the slowest option and may lead to large reports.

 The All check level is intended to be used only in rare circumstances to investigate a particular limit state at a particular location in the model. The Each Limit State check level produces the same design results as the All check level, but with much better performance since only stores the controlling design check for each limit state. Using the All check level to try and design an entire model or to design a large Design Group can significantly reduce the program's performance. Explore the differences between the Each Limit State and All check levels in a simple model prior to using the All check level in a large or complex model.

## 5.2.3 Bracing

VisualAnalysis assumes that the length of a member element is equal to the unbraced length. It is up to you when you create a design group, to specify the actual unbraced length for members in the group. This is one of the key criteria that you will use in determining which members to group together. Bracing is not automatic in *VisualAnalysis*, you must pay attention to this important detail. The terms top and bottom relate to the member's section axes, and may not refer to the actual 'top' of the member!

### Graphics

To see the location of bracing on a member use the **Brace Locations** checkbox found in the Member Details section in the **Filter** tab while in the **Design View**.

### Three Directions to Brace:

1. **Lateral Top** (+y): at the +y face of the member, for strong flexure checks
2. **Lateral Bottom** (-y): at the -y face of the member, for strong flexure checks
3. **Strong** (z): for axial compression checks
4. **Torsional** (x): for twist in each of the above directions (steel only) other assume Minimum(KLz, KLy) as needed.

### Ways to Specify Brace Positions

These are brace locations along the length of each member element.

- Unbraced
- Bracing Patterns (e.g. midpoint, third point)
- Bracing Fractions
- Specified Unbraced Length
- At Interior Crossings (for members with intermediate connections)

### Bracing Patterns

By default, each member element is braced at its end points and unbraced along its length. Bracing patterns allow you to define intermediate bracing points that are not part of the *VisualAnalysis* model.

You may specify a bracing pattern like continuous, mid-point, third-point, or quarter-point. This means that for each member element, a brace is assumed to restrain the member against buckling at these specific positions along the member. This is a fast and easy way to specify the bracing and it can work well even if the members are of different lengths. You may also restore members to the default unbraced state using patterned bracing.

### Bracing Fractions

By default, each member element is braced at its end points and unbraced along its length. You may use fractional bracing to define the locations of intermediate brace points along members.

Fractional bracing is similar to Bracing Patterns but allows an essentially unlimited number of patterns. You simply specify that braces exist at specific fractions of the member element length. These fractions are defined from the start-end of the member element. You create a list of fractions to locate braces at arbitrary positions along each member element.

This method also works if member elements have differing lengths. Fractions should be listed in increasing order in the range of zero to one. For example, "0.5, 0.625, 0.79"

## Specified Unbraced Length

When you specify a specific unbraced lengths, these braces are assumed to exist at fixed distances from the 'start' end of the member element until the end of the member is reached. You may specify an unbraced length that is longer than the member-element length to model things like a chain elements that is not exactly straight and where VisualAnalysis will not allow a 'Combined Member'

Using the specified unbraced length can result in an incorrect calculation for the  $C_b$  value and other possible errors in checks--please use wisely.

## At Interior Crossings

VisualAnalysis provides a convenience feature that lets you combine member elements into a single composite member for design or reports. Behind the scenes the member consists of multiple elements with interior node points. The design software does not automatically "see" the interior node points as braced points, but you may specify this option in the bracing.

## 5.2.4 Deflections

Deflections are checked for load combinations that have been marked as "Deflection" or "Allowable and Deflection" in the [Load Case Manager](#).

You must **choose** the method for checking deflections! For **cantilevered beams you generally need to check "total" deflection** (described below). Depending on how your model is constructed (e.g. combined members or separate member-elements), or how members are grouped together, you may need to change the type of displacement check! The measured displacements can change dramatically (and even reverse direction!) depending on the method chosen.

### Span Ratio vs. Actual Deflection

You may specify a limit based on a span ratio (like  $L/360$ ), or a specified displacement limit (like 0.25 inches). The span ratio approach allows you to group members that may not have the same span length, yet still provide a consistent deflection limit. You may disable specific limits by setting a zero value (for a displacement limit) or a small value (for a span-ratio limit).

The **span-length** is calculated as the member-element length, or for a combined member it is the total length--regardless of the types of internal connections or supports! Span-ratio checks may not make sense for combined members that are supported in their interior. Span-ratio checks generally do not work for cantilevered members.

### Relative Member vs. Total Deflection

You will also need to choose between two methods of measuring the actual deflection. VisualAnalysis uses the terms "Member" and "Total" to distinguish between bending deflection in a member *element* and the total movement of a member including the nodal displacements.

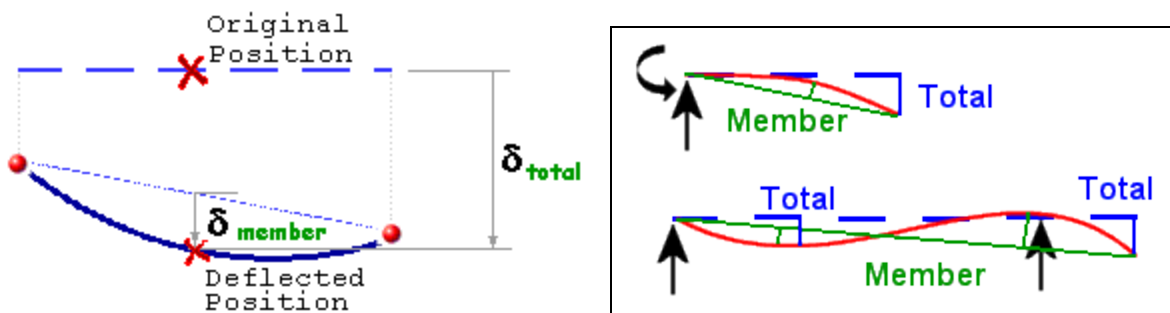

In the picture on the right above, the **member deflections** are calculated from the green-line between the deflected end-points to the red-line (the deflected beam), while the **total deflections** are calculated from the dashed-blue line.

In many cases, the member and total displacements will be identical. This is true for a simple span beam, or (approximately) a beam framing between two columns. In the case of a beam split into multiple elements you will need to make sure that you are checking a total displacement. In the case of a beam spanning between two girders, and the girders are also deflecting, then you will want to check member displacements for this beam. Finally in some situations you will simply need to check absolute displacements that you have pre-calculated. Using the span-ratio limits does not work for all situations in modeling, though it is most convenient for typical beams.

## Load Combination Deflection Categories

You can view deflection categories in the **Load Case Manager**, on the combinations page for any load combinations marked for "Deflection" or "Allowable and Deflection" checks. See [loading for design](#) for more details.

You can specify different deflection limits for each category in a Design Group's parameters.

## Column Drift Checks

VisualAnalysis does not directly check drift requirements. There are special **Reports** available to show building or member drift that you may use to check your drift requirements and make frame-wide adjustments as necessary. The "Complete Member" report item will display the actual drift extremes calculated for a column member.

## 5.2.5 Design Parameters

Design parameters control how unity checks and design searches are performed for a Design [Group](#). You enter this information in the **Modify** tab after selecting a member or a Design Group in the **Design View** window. While many of these parameters are specific to the type of material you use, there are some common design parameters across some of the design modules. For example, steel, wood, and cold-form steel design all use similar bracing, size constraints, and deflection criteria.

### Bracing

Members are unbraced by default. See [bracing](#).

### Deflection Limits

Specify the span ratio or absolute limit for allowable deflections. Select the [type of deflection](#) to use in the checks: relative or total.

### Live Load Reduction

You can specify a live load reduction level for all the members in this design group. Only load combinations utilizing that level of live loads will be checked. You set up live load reduction levels using the **Load Case Manager**.

### Size Constraints

One common design criteria is limited space. If the architect has mandated a minimum floor to ceiling height, you will probably need to limit the depth of your beams and girders. VisualAnalysis supports this using a size constraints. Size constraints can also dramatically improve the performance of the software when searching for a least-weight member to meet your design criteria.

If you have specified a size constraint, it will also be checked during unity checks of existing members. If a member violates the size constraint, there will be a "flag" on the check and the member will appear differently in the Design View.



You will see a note in the fly-over tip regarding the violation or a note in the report.

## Design Material

You do not specify any design material in the Design View or Design Group parameters. Members in your model have a shape and material defined in the Model View, prior to analysis. The material is not changed by design operations, the but shape may be.

## Axial

Axial parameters provide information about the frame in which the members of this design group reside. You may ignore the axial parameters if designing members without axial loads. You have the option of overriding the effective length factors and can indicate whether the frame is braced or not. The directions referred to on this page are interpreted according to the section axes of each individual member element in the group. This means that if you have a frame that is braced in one direction and not the other, you should not place members whose orientations are different into the same design group.

**Sidesway y:** Choose yes if the member is part of a sway frame in the plane formed by its section z and local x axes. Choose no if it is part of a braced frame in this plane. If the automatic K factor calculation is on for  $K_y$ , the sidesway y parameter will effect the calculation of the  $K_y$  value.

**Sidesway z:** Choose yes if the member is part of a sway frame in the plane formed by its section y and local x axes. Choose no if it is part of a braced frame in this plane. If the automatic K factor calculation is on for  $K_z$ , the sidesway z parameter will effect the calculation of the  $K_z$  value.

**Manual  $K_y$ :**  $K_y$  is the effective length factor for buckling when the member kicks out in its section z direction (normally weak axis buckling). If Set  $K_y$  is left set to no, the effective length factor will be calculated automatically based on the relative rigidity of the members framing in at its end points. If Set  $K_y$  is set to yes, the  $K_y$  value must be entered.

**Manual  $K_z$ :**  $K_z$  is the effective length factor for buckling when the member kicks out in its section y direction (normally strong axis buckling). If Set  $K_z$  is left set to no, the effective length factor will be calculated automatically based on the relative rigidity of the members framing in at its end points. If Set  $K_z$  is set to yes, the  $K_z$  value must be entered.

## 5.3 Design Topics

**Requires: 2D Design Level**

### Introduction

The Design and Advanced levels of VisualAnalysis offer sophisticated code-checking and member sizing capabilities which are broadly classified as 'design'. The design software implements various material specifications for checking aluminum, cold-formed steel, concrete, steel, and wood elements. Stress and deflection checks can also be performed for custom member shapes and/or materials. Prior to using or trusting design checks, it is important to verify that the model is producing reasonable analysis results since these results are used in the design checks. VisualAnalysis is also integrated with other IES products which support a variety of specialized design features as described below.

### Design Essentials

- [Design Groups](#)
- [Unity Checks](#)
- [Bracing](#)
- [Deflection Checks](#)
- [Performance Tips](#)

## How To

- [The Design Process](#)
- [Loading for Design](#)
- [Modeling for Design](#)
- [Analyzing for Design](#)

## Design Types

- [Building Code Support](#)
- [Steel Design](#) (AISC / CISC)
- [Composite Beam Design](#) (AISC)
- [Aluminum Design](#) (ADM)
- [Wood Design](#) (NDS)
- [Concrete Design](#) (ACI / CSA)
  - [Concrete Beam Design](#)
  - [Concrete Column Design](#)
  - [Concrete Wall/Slab Design](#)
- [Cold-Formed Steel Design](#) (AISI and more)
- [Stress & Deflection Checks](#) (Generic & Custom)

## Foundation Design

- **Export** to [IES QuickFooting](#), a separate IES product for spread-footing design. This process is summarized on the [QuickFooting](#) page.
- **Export** to [IES VisualFoundation](#), a separate IES product for complex mat foundation design. This process is summarized on the [VisualFoundation](#) page.

## Steel Connection Design

- **Export** to [IES VAConnect](#), a separate IES product for steel connection design. This process is summarized on the [VAConnect](#) page.

## Other Design Support

Double-click on a member in the Design View to see exactly which checks controlled the design. The "Design Group Results" report include specification references, controlling load case, demand and capacity values, as well as intermediate results or parameters such as unbraced length, K factors, load duration factors, rebar details, etc. Additionally, there are some report tables available (in all levels of VisualAnalysis) that can help the user perform additional design calculations outside of VisualAnalysis (such as member relative deflections, column drift, member moment magnification, etc.). Reports can be exported using the clipboard or by saving a file that can be used in a spreadsheet or other tool.

## 5.4 Wood Design

**Requires: 2D Design Level**

### Introduction

VisualAnalysis performs the design of wood members (beams, columns, braces, etc.) according to the following design specification:

- NDS 2018 ASD & LRFD

Wood members are designed for flexure (strong axis and weak axis), shear, tension, and compression to resist the varying demands along the length of the member. When necessary, the interaction of these loads are accounted for in the design checks per the selected design specification. The maximum unity value (demand to capacity ratio) for the member is shown in both the Design View and in the Report View, allowing the user to quickly identify if the member is passing (unity  $\leq$  Unity Success Limit) or failing (unity  $>$  Unity Success Limit). In addition to checking the capacity for wood members, VisualAnalysis can check the deflection limits for the members based on the deflection limits set by the user and the Deflection Check load combinations. The dimensions for the wood members can be manually adjusted in the **Project Manager | Modify** tab until a satisfactory design is reached or VisualAnalysis can automatically optimize the dimensions for the Design Group using the Design the Group button in the Design Ribbon. VisualAnalysis can design members that are made of solid-sawn, post/pile, glued laminated shapes, and some structural composite lumber.

## Wood Design Capabilities

- NDS Database Shapes and Standard Parametric rectangle and round shapes can be designed in VisualAnalysis.
- Performs code checks for visually and mechanically graded dimension lumber, visually graded timbers, round timber poles and piles, glued laminated timbers, and some structural composite lumber shapes.
- Capacity design checks include bending (strong & weak), shear (strong & weak), tension, compression, combined bending and axial tension (NDS 3.9.1), and combined bending and axial compression (NDS 3.9.2). Note: Equation 3.9-1 has been modified to account for the effects of biaxial bending.
- VisualAnalysis can provide deflection checks for wood members. To obtain deflection checks, deflection load combinations must be included in the in the Load Case Manager. More information is available on the [Deflections Page](#).
- Shapes used in design include those listed in Part 3 of the NDS Supplement (standard dressed and glued laminated shapes), as well as a selection of rough sawn and full sawn rectangular members and posts. The database may be customized to include additional sections.
- Allowable stresses used in design are based on Part 4 of the NDS Supplement.
- Allows user-specified bracing patterns and deflection limits.
- Allows user-specified modification factors.
- Account for reductions in cross sectional area due to bolt holes in axial check.
- Reports include tabulated stresses, factored stresses, and adjustment factors.
- Notch provisions of NDS 3.4.3.2 are included.

## Load Duration Factor $C_D$

Load duration factors for wood design are specified in the NDS Table 2.3.2 as a function of the longevity of applied loads (e.g. dead loads are assumed to be permanent, live loads are assumed to last up to ten years, etc.). VisualAnalysis automatically determines the load duration factor based on the "load sources" used in the design load combinations. The shortest duration source in the combination is used. The following table shows the duration factors that are used for the load sources (note: impact loads are not considered in VisualAnalysis).

Load Source	$C_D$
Dead, or other loads	0.9
Live	1.0
Snow	1.15

Load Source	$C_D$
Roof Live Loads	1.25
Wind or Seismic	1.6

## Custom Materials & Structural Composite Lumber

The allowable stresses for Structural Composite Lumber are provided by the manufacturer. VisualAnalysis currently provides the values for members manufactured by Boise Cascade and Weyerhaeuser. If the desired Structural Composite Lumber or any other wood material is not found, simply create a custom material by clicking the Add Custom Material button in the Material Database dialog box and manually enter the Defining Properties. The following types of custom wood materials can be created: Lumber, Timber, Piles and Poles, Structural Composite Lumber, and Glulams.

## Wood Design Parameters

Several parameters must be defined to design wood members in VisualAnalysis. The design parameters are set in the **Project Manager | Modify** tab when the Design View is selected. After creating a Design Group, choose one of the members that belongs to the group in the Design View to set up the Design Group's Parameters. Since the design parameters apply to all members in the Design Group, it is often best to choose the most conservative condition that applies to any member in the group.

Nearly all of the C-Factors can be manually overridden in VisualAnalysis - the Load Duration Factor ( $C_d$ ) being one of the exceptions. Overriding a modification factor causes the input value to be used in the design checks throughout the entirety of the Design Group and for every load case. Therefore, caution should be used when overriding a modification factor and the results should be double checked. In some instances, a modification factor can have no effect on the design check in a particular Design Group. For example, since the Volume Factor,  $CV$ , is only applicable to glued laminated timber or structural composite lumber it will not be used in the design checks for lumber, timbers, or piles and poles.

<b>Wood</b>	<b>Specification</b> - The Design Specification used to design the members in the Design Group. <b>Overstrength?</b> - Causes the Design Group to be designed using overstrength load combinations. <b>Live Load Reduction</b> - If specified, design checks will only consider result cases with the matching live load reduction. Combinations with live load reduction can be created in the <b>Load Case Manger</b> . <b>Disable Checks?</b> - Causes selected Design Group to be omitted from design checks. This feature can be used to speed up design checks and focus on targeted areas of larger models. <b>Check Level</b> - Determines the level of detail reported from design checks. Options are: <i>To Failure</i> (Fastest), <i>Each Limit State</i> , and <i>All</i> (Slowest, but provides the most information).
<b>Bracing</b>	<b>Lateral Top (+y)</b> - Lateral bracing at the top side of the member (+y). Choose a bracing arrangement. <b>Lateral Bottom (-y)</b> - Lateral bracing at the bottom side of the member (-y). Choose a bracing arrangement. <b>Strong (z)</b> - Brace against strong-axis buckling for columns.
<b>Size Constraints</b>	<b>Limit Depth/Width?</b> - Allows the design search to 'Fail' if the shape is outside the Min/Max range.
<b>Configuration</b>	<b>Has Bolt Holes</b> - Choose if bolt holes in the member should be considered for the axial (pure axial and combined axial + bending) design checks. Bolts are assumed to go through the width of the member (the 'b' dimension). This feature is only valid for rectangular sections. <b>Multi-Piece Lams</b> - Choose if the shear stress value ( $F_{vy}$ ) should be reduced to account for a member

that is manufactured from multiple piece laminations with unbonded edge joints.

## Axial

**Manual  $K_z/K_y$**  - Allows the user to manually override the effective length factors for the strong/weak axis.

**$K_z/K_y$  Sidesway?** - Choose if the member is apart of a sway frame in the specified direction.

## Beam

**Beam Type** - Specify the support conditions for the flexural member (simply supported, continuous, or cantilevered) to determine the effective length (le) of the member used to calculate the Beam Stability Factor, CL.

**Loading Pattern** - Specify how the flexural member is loaded to determine the effective length (le) of the member used to calculated the Beam Stability Factor, CL.

**Tension Flange on Bottom?** - Is the tension flange/side of the beam on the bottom (geometric -y face) of the member? Important: this refers to the shape's XY coordinate system, not the member's YZ system. Check the allowable stress in the design report to verify the setting.

**Override Lbi?** - Override the automatically calculated length between the inflection points of a member. This may be necessary if the length between inflection points extends beyond the endpoint(s) of a model member. This length is used in calculating the Volume Factor, CV.

**End Notch Type** - Indicates whether or not the beam has end notches (tension face or compression face). Refer to NDS 3.4.3.2 for the reductions in shear capacity at notch locations. If a notch type is selected, the notch depth and possibly the notch offset must be specified (see in Figure 3D of the NDS). The depth of the member remaining at a notch measured perpendicular to the length of the member,  $d_n$ , is the beam depth minus the input notch depth.

## Deflections

**Strong (dy)** - Specify the type of limit for beam deflections in the y-direction. Use Total to include the displacements of the nodes at each end of the element.

**Weak (dz)** - Specify the type of limit for beam deflections in the z-direction. Use Total to include the displacements of the nodes at each end of the element.

## C-Factors

**Moisture Condition** -Select the service moisture condition. This will influence the Wet Service Factor (CM) and the Temperature Factor (Ct).

**Temp. Range** - Specify the extreme temperature condition. This will influence the the Temperature Factor (Ct). See NDS 2.3.3.

**Wet Service Factor, CM** - Select how the Wet Service Factor (CM) is used in the Design Group. Reference design values are based on the moisture service conditions specified in NDS 4.1.4 (sawn lumber) or 5.1.4 (glulam). Overriding this factor causes the input value to be used in the design checks throughout the entirety of the Design Group. Calculated CM factors might otherwise vary.

**Temperature Factor, Ct** - Select how the Temperature Factor (Ct) is used in the Design Group. When structural members will experience sustained exposure to elevated temperatures, reference design values should be multiplied by Ct, specified in NDS 2.3.3. Overriding this factor causes the input value to be used in the design checks throughout the entirety of the Design Group. Calculated Ct factors might otherwise vary.

**Incising Factor, Ci** - Select how the Incising Factor (Ci) is used in the Design Group. Overriding this factor assumes the incising criteria in NDS 4.3.8 is met and the input value is used throughout the entirety of the Design Group. Calculated Ci factors might otherwise vary.

**Repetitive Member Factor, Cr** - Select how the Repetitive Factor (Cr) is used in the Design Group. When set to Calculate, the repetitive factor will be uses per NDS 4.3.9. This option is only available for

dimension lumber and structural composite lumber.

**Buckling Stiffness Factor, CT** - Select the Buckling Stiffness Factor (CT) is used in the Design Group. This option is only available for visually and mechanically graded dimension lumber and assumes the members meet the criteria listed in NDS 4.4.2.1.

**Slenderness Limit Increase** - KM is a parameter used in calculating the Buckling Stiffness Factor (CT).  $KM = 2300$  for wood seasoned to 19% moisture content or less at the time of plywood attachment.  $KM = 1200$  for unseasoned or partially seasoned wood at the time of plywood attachment. See NDS 4.4.2.1.

**Curvature Factor, Cc** - Enter a Curvature Factor to use adjust the Reference Design Bending Value ( $F_b$ ) for glued laminated beams only. The input value is in the design checks throughout the entirety of the design group.

**Pole/pile Treatment** - Indicate what type of treatment this pole/pile has. This influences the condition treatment factor, Cct.

**Pole/Pile Group Count** - Indicate how many piles are in a group sharing load. This influences the load sharing factor, Cls.

## Overrides

**Override CF** - Override the size factor (CF). Use only when conditions meet those specified in NDS 4.3.6. Overriding this factor causes the input value to be used in the design checks throughout the entirety of the Design Group. Some factors might otherwise vary.

**Override CI** - Override the stress interaction factor (CI). Used for tapered glulam members, specified in NDS 5.3.9. Overriding this factor causes the input value to be used in the design checks throughout the entirety of the Design Group. Some factors might otherwise vary.

**Override CL** - Override the Beam Stability Factor (CL). Used for reference bending design values ( $F_b$ ) as specified in NDS 3.3.3. Overriding this factor causes the input value to be used in the design checks throughout the entirety of the Design Group. Some factors might otherwise vary.

**Override CP** - Override the Column Stability Factor (CP). Used for reference design values parallel to grain ( $F_c$ ) as specified in NDS 3.7. Overriding this factor causes the input value to be used in the design checks throughout the entirety of the Design Group. Some factors might otherwise vary.

**Override CV** - Override the Volume Factor (CV). Used when structural glulam or structural composite lumber members are loaded in bending about the x-x axis, specified in NDS 5.3.6. Overriding this factor causes the input value to be used in the design checks throughout the entirety of the Design Group. Some factors might otherwise vary.

**Override Ccs** - Override the Critical Section Factor (Ccs). Compression design values for piles and poles are based on the strength at the tip. The increase for location of critical section shall not exceed 10% ( $Ccs \leq 1.10$ ) as specified in NDS 6.3.9. Overriding this factor causes the input value to be used in the design checks throughout the entirety of the Design Group. Some factors might otherwise vary.

**Override Cct** - Override the Condition Treatment Factor (Cct). This factor is applied to piles and poles if conditioning other than air-dried was used prior to treatment, specified in NDS 6.3.5. Overriding this factor causes the input value to be used in the design checks throughout the entirety of the Design Group. Some factors might otherwise vary.

**Override Cfu** - Checking this option allows you to override the flat use factor, Cfu. Used when sawn lumber 2 to 4 in. thick is loaded on the wide face, specified in NDS 4.3.7. Overriding this factor causes the input value to be used in the design checks throughout the entirety of the Design Group. Some factors might otherwise vary.

**Override Cls** - Override the Load Sharing Factor (Cls). For piles, reference design values are based on single piles. If multiple piles are connected by force distributing elements so that the pile group deforms as a single element, this factor is used, specified in NDS 6.3.11. Overriding this factor causes

the input value to be used in the design checks throughout the entirety of the Design Group. Some factors might otherwise vary.

**Override Cvr** - Override the Shear Reduction Factor (Cvr). Used for the design of non-prismatic members, members subject to impact or cyclic loading, members at notches, or members at connections, specified in NDS 5.3.10. Overriding this factor causes the input value to be used in the design checks throughout the entirety of the Design Group. Some factors might otherwise vary.

## Material Overrides

**Override Ft (Poles & Piles)** - Override the allowable stress for axial tension, Ft.

**Neglect Size Constraints?** - Should the Size Checks allow a Beam/Stringer material to be used with Post/Timber shapes? See NDS 4.1.3.3.

## Wood Member Design Process

To achieve an adequate design, the size of the members in a Design Group can be manually adjusted until all the design checks pass. Alternatively, the built in optimization feature in VisualAnalysis can be used to find an adequate size for the members in a Design Group. The optimization feature can be used to search for adequate Database Shapes or to iterate through the parameters of a Standard Parametric shape until an adequate shape is found.

### 1. Create the Members

In the Model View draw or create the wood members.

### 2. Support and Load the Members

Define support conditions for the model and apply the service level loads to the members. Set the load combinations in the Load Case Manager.

### 3. Specify the Parameters

Select a preliminary wood Database Shape or Standard Parametric Shape and set the material properties.

### 4. Analysis and Preliminary Design

VisualAnalysis will automatically analyze the model and perform the appropriate design checks. Simply click on the Results View tab to view the analysis results for the model or the Design View tab to see the design results.

### 5. Create/Modify Design Groups

VisualAnalysis will automatically create groups for members based on material, orientation, length, and/or cross-section. Alternatively, Design Groups can be created or modified manually as explained in the [Groups Category](#).

### 6. Define the Parameters

For each Design Group, set the wood parameters (design specification, overstrength, etc.) in the **Project Manager | Modify** tab in the Design View. Also, adjust the bracing, size constraints, configuration, axial, beam, deflections, C-factors, overrides, and material overrides for the Design Group as needed.

### 8. Design the Group

After selecting a wood Design Group, click the Design the Group button in the Design ribbon. In the Design Selection dialog box, choose the search type (Database or Parametric) and set the number of shapes to be returned from the optimization. For a database search, choose which database is to be searched and the category of shapes (Dimensional Lumber, Glulam, Post, or Timber) that are to be searched within the database. Also, set the size constraints if needed. For a Parametric search, select the parametric type (Rectangle or Circle) and specify the search range (Start and End) and the Increment for each parameter of the shape or choose to hold the parameter constant. Once the search parameters are set, click the Optimize Now button to search for various sections and display the unit value for each shape. If a warning stating "demands could not be satisfied" appears, then all the shapes within the search parameters have a unity value larger than

the Unity Success Limit defined in the Preferences. Enabling the Return all Shapes feature will provide information on every considered section which may be useful for determining why a section failed or was not optimal.

## 9. Select a Section

Once the optimization is complete, select a section from the list and click the Accept Design button. Now the unity value for all members in the design group are displayed using the selected section. The tilde symbol (~) in front of the unity value indicates that the unity checks must be validated with another analysis since the member stiffness and resulting load distribution may have changed.

## 10. Synchronize Design Changes

Click the Synchronize Design button in the Design ribbon to automatically update the model with the new cross-section, re-analysis the model with the new member stiffness, and rerun the design checks with the updated analysis results.

## 11. Verify Unity Ratios

The final step in the design process is to verify that Unity Ratios in the Design View are less than the Unity Success Limit defined in the Preferences. If member sizes were drastically changed during the design process, final unity ratios can differ from predicted unity ratios because the analysis results may vary significantly.

## Wood Reports

Design reports are available by double-clicking on a member in the Design View, by selecting a member and clicking the Report Selected button in the **right-click** context menu, or by adding tables individually from the Report View. The notation used in the reports is similar to that used in the NDS specification. In general, allowable stresses use an upper case 'F', such as Fb for bending, Fv for shear, etc., while actual stresses use a lower case 'f'. The wood design reports in VisualAnalysis are highly customizable. To control what is included in a report, simply click on a table in the report and adjusted the settings in the **Project Manager | Selected Table** tab. The Extreme Rows feature is particularly useful to produce concise reports of only the controlling cases or to produce detailed reports that display every design check that is made. When this feature is set to Show All, the reports may become excessively large which can be controlled by adjusting the Conciseness feature. The reports for wood design include both a summary of the parameters input for the Design Group and tables that included the various design checks. These tables have the following columns:

Column Name	Description
Member	The member's name.
Section	The member's cross-section (e.g. Rectangle 2 x 10).
Offset	This is the distance from the 'start' end of the member. The number and locations of offsets are as defined in the performance settings in VisualAnalysis.
Result Case	The result case that is used for the design check.
Demand/Capacity	These columns varies depending on the type of design check (fb & Fb, fv & Fv, etc). In most cases these values are used directly in the unity check.
Code Reference	The controlling equations or provisions from the chosen design specification. For example, "3.3-1" refers to the equation in the NDS specification while a reference like "3.6.3" refers to a section in the specification.
Unity Check	The unity check value for this particular member, load case, and offset. Unity checks are calculated as the absolute value of an actual stress divided by an allowable stress [ASD] or as the ultimate stress (factored) divided by the design stress (factored) [LRFD].
Details	Intermediate values and other information which can be helpful for validating results.



## Assumptions & Limitations

VisualAnalysis makes the following assumptions or has the limitations described below:

- Connections are fabricated such that each member is loaded concentrically.
- Member span is conservatively taken as the full length from center-to-center of supports.
- Wood materials are defined with "oven-dry moisture" density. Therefore, the self-weight may need to be adjusted for wood with high moisture content.
- Shear force is conservatively taken at the end of the member (reductions according to NDS 3.4.3.1 are not considered).
- Some glue laminated timbers have different stress ratings for the "top" (Compression Zone per NDS) and "bottom" (Tension Zone per NDS) member laminations. The tabulated database stresses for glulam members are dependent on whether or not the intended "Tension flange" is in tension. Therefore, the orientation of the member in the model is critical for design. In VisualAnalysis, the "bottom" of glue laminated timbers is defined as the -y face of a member (member local axes). Use the Tension Flange on Bottom? setting in the **Project Manager | Modify** tab to specify if the bottom of the member is the tension flange or the compression flange.
- When calculating the volume factor CV, the width, b, of glued laminated timbers wider than 10.75 inches is taken as 10.75 inches according to NDS 5.3.6.
- When 4 or more laminations are used, Table 5B values assuming special tension laminations are used.
- Post and Pile designs assume that the untreated factor,  $C_u$ , is applicable.
- Notches, when specified, are assumed to exist at critical shear position along the member's length.
- By default, the unbraced length for a member is assumed to be the member-element length between nodes. See [Bracing](#) for more information on member bracing.
- I-Joists and similar "Engineered Products" are not supported. Use the [stress-check \(generic\)](#) module to get preliminary checks for these shapes .
- Torsion is not checked and a warning will appear when significant torsional moment is present in a member.
- Bearing (compression perpendicular to grain) is not checked.
- Provisions for special loading conditions (NDS Chapter 15) are not used.
- The Buckling Stiffness Factor (CT) is calculated using the greater of the model member length and its designated strong axis unbraced length. If members that qualify for the buckling stiffness factor are broken into multiple segments, the strong unbraced length of the members must be changed to reflect the appropriate length.
- The Load Duration Factor ( $C_d$ ) cannot be overridden as it is affected by load combinations as mentioned above.
- Tapered members are checked with the starting member shape as if they were prismatic.

## Wood References

1. American Forest and Paper Association, [National Design Specification for Wood Construction](#). 2018 Edition.
2. Breyer, Donald E., [Design of Wood Structures](#). Third Edition, McGraw Hill, Inc., 1993.

## 5.5 Steel Design

**Requires: 2D Design Level**

### Introduction

VisualAnalysis performs the design of hot rolled steel members (beams, columns, braces, etc.) according to the following design specifications:

# VisualAnalysis 19 User's Guide

- AISC 360-16 ASD & LRFD
- AISC 360-10 ASD & LRFD
- AISC 360-05 ASD & LRFD
- CSA S16-14 LRFD

Steel members are designed for flexure (strong axis and weak axis), shear, torsion, tension, and compression to resist the varying demands along the length of the member. When necessary, the interaction of these loads are accounted for in the design checks per the selected design specification. The maximum unity value (demand to capacity ratio) for the member is shown in both the Design View and in the Report View, allowing the user to quickly identify if the member is passing (unity  $\leq$  Unity Success Limit) or failing (unity  $>$  Unity Success Limit). In addition to checking the capacity for steel members, VisualAnalysis can check the deflection limits for the members based on the deflection limits set by the user and the Deflection Check load combinations. The shapes for steel members can be manually adjusted in the **Project Manager | Modify** tab until a satisfactory design is reached or VisualAnalysis can automatically optimize the shape for the Design Group using the Design the Group button in the Design Ribbon. Also, the [AISC Direct Analysis Method](#) requires LRFD design checks. [Composite beams](#) can be checked using the AISC specifications.

## Steel Design Capabilities

### Shape Types

VisualAnalysis can perform steel design using Database Shapes, Standard Parametric shapes, or custom shapes that have the required shape properties for design. For example, AISC, CSA Steel, and Euro Steel shapes can all be designed according to the aforementioned AISC and CSA design specifications while cold-formed steel shapes cannot be designed using these specifications. The IES Shape Database can be customized to include libraries of custom, foreign, or legacy shapes. The following Standard Parametric shapes are supported by VisualAnalysis for steel design: angle, channel, circle, I-shape, pipe, rectangle, rectangular tube, and tee (spandrel and zee shapes are not supported for steel design). Custom shapes can be created using [IES ShapeBuilder](#) and are supported for steel design in VisualAnalysis given the required shape properties.

### Seismic Compactness

Member elements can be checked for seismic compactness per the AISC Seismic Provisions (341). This check depends on the ductility requirements for the member (Non Ductile, Moderately Ductile, or Highly Ductile) and the ratio of expected yield stress to the specified minimum yield stress ( $R_y$ ) which are defined by the user.

### Bracing

By default, the unbraced length for a member is assumed to be the member-element length between nodes. The lateral top/bottom unbraced length is used for the flexural design checks while the strong unbraced length is used for the compression design checks. See [Bracing](#) for more information on member bracing.

### Deflections

A variety of options are available to specify the deflection limits. To obtain deflection checks, deflection load combinations must be included in the in the Load Case Manager. More information is available on the [Deflections Page](#).

## Flexure, Shear, and Axial Load Design

VisualAnalysis designs steel members for flexure (strong axis and weak axis), shear, torsion, and tension according to the provisions outlined in the chosen design specification. All member forces are with respect to the member's principle axes which may not align with the geometric axes (as is the case for asymmetric shapes like single angles). When the model is sufficiently supported, loaded, and has the appropriate load combinations, the steel design checks are performed

automatically. When necessary, members are checked for both their strong and weak axes and the interaction of the combined loads is accounted for according to the chosen design specification. For more information on how specific design checks are performed, see the code references for the design checks that are listed in the result tables.

## Torsion Design

### Design Specification

All torsion checks are based on the AISC provisions. The Canadian steel code (CSA) does not provide specific requirements for torsion design (per CSA section 14.10). The general requirements given in CSA are satisfied using the more detailed requirements given in AISC 360 and AISC Design Guide 9.

### Torsion Check Types

The following limit states are checked in VisualAnalysis during the torsion design process:

1. Torsional shear stresses are compared to the capacities from AISC equations H3-1 for closed shapes and from AISC equation H3-8 for open shapes.
2. Torsional normal stresses are compared to the capacity from AISC equation H3-7.
3. Combined Stresses with Torsion are evaluated using the equations described below.

Note: The limit state described by AISC equation H3-9 is not checked as there is no guidance for calculating  $F_{cr}$  in the specification.

### Torsion Design Levels

VisualAnalysis provides two levels of torsion design.

1. Limited Torsion Design - When shapes with an open cross-section are twisted they tend to warp. If such a member is designed in VisualAnalysis without specifying idealized torsional boundary conditions warping is neglected. When warping is neglected the entire torsional moment is assumed to be resisted by uniform or Saint Venant shear stresses. Neglecting warping can result in incorrectly low unity values in some cases and incorrectly high unity values in others. If the limited torsion design is used for a member subject to warping, the design done by VisualAnalysis is incomplete. The complete design would need to be done outside of the software.
2. Advanced Torsion Design - The advanced torsion analysis uses a numerical solution process to solve the differential equation associated with warping (see AISC's Design Guide #9 for a summary of torsion theory). The solution is based on idealized boundary conditions provided by the user, and the internal torsion distribution calculated during the finite element analysis. The solution determines the angle of rotation along the length of the member and the first two derivatives of the rotation. Using this information warping normal stresses, warping shear stresses, and uniform shear stress can be calculated for a given shape. Advanced torsion design is based on warping section properties for shape types (i.e. I-Beam or Channel) and these calculated section properties may differ from published values. Advanced torsion design is only available in the Advanced level of VisualAnalysis.

When closed shapes are designed, limited and advanced torsion processes will produce similar results. While AISC only explicitly requires the combination of shear and normal stresses for HSS cross-sections, VisualAnalysis conservatively calculates them for all cross sections (even though they are unlikely to control) because it makes sense to do so from a mechanics viewpoint.

### Torsion Boundary Conditions

Torsion Boundary Conditions are idealized as one of the following during design in VisualAnalysis.

Torsion Boundary Condition	Physical Meaning	Mathematical Meaning
Pinned	The cross-section cannot twist, but can warp freely.	$\theta = 0$ and $\theta'' = 0$
Fixed	The cross-section cannot twist or warp.	$\theta = 0$ and $\theta' = 0$
Free	The cross-section can twist and warp freely.	$\theta'' = 0$

where  $\theta$  is the angle of rotation (twist)

The options listed above are idealized boundary conditions. Boundary conditions between these options cannot be considered in VisualAnalysis. Furthermore, the idealized boundary condition used for design may conflict with the boundary condition used during analysis. For example, one member's twisting support may be provided by the bending stiffness of another member it frames into. In this scenario, twisting is restrained at the end and torsional moments can develop, but the rotation may still be greater than zero at the end. If during design the ends of the beam are idealized as torsionally pinned the design software will force the rotation at the ends to be zero when solving the differential equation. **Sound engineering judgment must be used when selecting the appropriate boundary conditions.** In some cases none of the idealized boundary conditions provided by VisualAnalysis will be appropriate, and the design will need to be completed outside of the software.

## Stress Superposition

When combining stresses for torsion design, VisualAnalysis conservatively combines the maximum stresses regardless of where they occur on the cross-section. This results in conservative unity values, but is not unreasonably conservative for most shapes and loadings.

## Combined Forces with Torsion

VisualAnalysis uses the following two equations to calculate unity values for the interaction of torsion with flexure and axial forces. The following equations are in their LRFD form; the ASD version is similar.

$$\frac{P_u}{\phi P_n} + \frac{M_{u,z}}{\phi M_{n,z}} + \frac{M_{u,y}}{\phi M_{n,y}} + \frac{\sigma_w}{\phi_T F_y} + \left( \frac{V_{u,z}}{\phi V_{n,z}} + \frac{V_{u,y}}{\phi V_{n,y}} + \frac{\tau_w}{\phi_T F_{n,w}} + \frac{\tau_{sv}}{\phi_T F_{n,sv}} \right)^2 \leq 1.0$$

$$\frac{V_{u,z}}{\phi V_{n,z}} + \frac{V_{u,y}}{\phi V_{n,y}} + \frac{\tau_w}{\phi_T F_{n,w}} + \frac{\tau_{sv}}{\phi_T F_{n,sv}} \leq 1.0$$

where:

"sv" denotes Saint Venant's stress

"w" denotes a stress from warping

$F_{n,sv} = 0.6 \cdot F_y$  for open shapes and is defined by AISC H3 for closed shapes.

$F_{n,w} = 0.6 \cdot F_y$

$\phi_T = 0.9$

The combined equations are based on AISC H3-6 and Design Guide #9 section 4.7. Combining the demands in the manner shown allows both open and closed cross sections to be checked with the same interaction equation. The AISC specification does not explicitly dictate how demands should be combined with torsion for open shapes.

The equation used to check combined stresses with torsion is more conservative than the combined equations for axial and bending found in sections H1 and H2 of AISC. Because of this AISC does not require the combined equation with torsion to be checked unless the torsion unity by itself is greater than 0.20. In VisualAnalysis a similar threshold of 0.10 is used for open shapes.

## Twisting Stiffness: Analysis vs. Design

The finite element formulation for beams in VisualAnalysis does not consider warping. Warping actually has a significant impact on a beam element's twisting stiffness. Because of this, the rotations calculated during the advanced torsion design process might vary significantly from the rotations calculated during the finite element analysis.

The advanced torsion design process uses the internal torsion distribution calculated during the finite element analysis. For an indeterminate problem, this distribution may have been different if warping stiffness had been considered during the finite element analysis. In light of this, the advanced torsion design may be performed using a torsion distribution that is incompatible with the more accurate torsional stiffness used in the design calculations. Judgment is needed to determine when the incompatibility is significant or unconservative.

## Segmented Members

Torsion boundary conditions are applied at the end of each member element. As a result, segmented members must be combined before the advanced torsion design will work. The software does not prevent a chain of individual member elements from being designed. In this case, however, each element will be designed on its own and the torsion boundary conditions will be applied at the interior nodes which will lead to incorrect design results.

## Steel Design Parameters

Several parameters must be defined to design steel members in VisualAnalysis. The design parameters are set in the [Project Manager | Modify](#) tab when the Design View is selected. After creating a Design Group, choose one of the members that belongs to the group in the Design View to set up the Design Group's Parameters. Since the design parameters apply to all members in the Design Group, it is often best to choose the most conservative condition that applies to any member in the group.

- Steel Specification** - The Design Specification used to design the members in the Design Group.
- Composite Beam?** - Are the members in the Design Group to be designed as a composite beams?
- Seismic Compactness** - Choose if the Design Group a member should be checked for seismic compactness according to the AISC Seismic Provisions (341).
- Check Constrained Axis FTB?** - Should constrained axis flexural torsional buckling be checked? This feature only applies to Wide Flange members.
- Overstrength?** - Causes the Design Group to be designed using overstrength load combinations.
- Live Load Reduction** - If specified, design checks will only consider result cases with the matching live load reduction. Combinations with live load reduction can be created in the [Load Case Manger](#).
- Disable Checks?** - Causes selected Design Group to be omitted from design checks. This feature can be used to speed up design checks and focus on targeted areas of larger models.
- Check Level** - Determines the level of detail reported from design checks. Options are: *To Failure* (Fastest), *Each Limit State*, and *All* (Slowest, but provides the most information).

# VisualAnalysis 19 User's Guide

- Bracing**
- Lateral Top (+y)** - Lateral bracing at the top side of the member (+y). Choose a bracing arrangement.
  - Lateral Bottom (-y)** - Lateral bracing at the bottom side of the member (-y). Choose a bracing arrangement.
  - Strong (z)** - Brace against strong-axis buckling for columns.
- Torsional Bracing**
- Lateral Top (+y)** - Do the specified braces on the top side of the member (+y) provide torsional restraint? This is used to determine the Torsional Unbraced Length.
  - Lateral Bottom (-y)** - Do the specified braces on the bottom side of the member (-y) provide torsional restraint? This is used to determine the Torsional Unbraced Length.
  - Strong (z)** - Do the specified braces for strong-axis buckling provide torsional restraint? This is used to determine the Torsional Unbraced Length.
- Deflections**
- Strong (dy)** - Specify the type of limit for beam deflections in the y-direction. Use Total to include the displacements of the nodes at each end of the element.
  - Weak (dz)** - Specify the type of limit for beam deflections in the z-direction. Use Total to include the displacements of the nodes at each end of the element.
- Axial**
- Manual  $K_z/K_y$**  - Allows the user to manually override the effective length factors for the strong/weak axis.
  - $K_z/K_y$  Sidesway?** - Choose if the member is apart of a sway frame in the specified direction.
- Size Constraints**
- Limit Depth/Width?** - Allows the design search to 'Fail' if the shape is outside the Min/Max range.
- Overrides**
- Override  $F_y$ ?** - Override the  $F_y$  value for the material used in the design checks. This feature is useful when wanting to design using the value from the mill certification rather than the minimum value.
  - Override  $C_b$ ?** - Disable the automatic determination of  $C_b$  and allows a custom value to be used.
  - Override HSS  $t_{des}$ ?** - Override the HSS design wall thickness.
  - Advanced Torsion** - Allows the warping stresses for torsion to be calculated

## Steel Member Design Process

To achieve an adequate design, the section for the members in a Design Group can be manually adjusted until all the design checks pass. Alternatively, the built in optimization feature in VisualAnalysis can be used to find an adequate shape for the members in a Design Group. The optimization feature can be used to search for adequate Database Shapes or to iterate through the parameters of a Standard Parametric shape until an adequate shape is found.

### 1. Create the Members

In the Model View draw or create the steel members.

### 2. Support and Load the Members

Define support conditions for the model and apply the service level loads to the members. Set the load combinations in the Load Case Manager.

### 3. Specify the Parameters

Select a preliminary steel Database Shape or Standard Parametric Shape and set the material properties.

### 4. Analysis and Preliminary Design

VisualAnalysis will automatically analyze the model and perform the appropriate design checks. Simply click on the Results View tab to view the analysis results for the model or the Design View tab to see the design results.

## 5. Create/Modify Design Groups

VisualAnalysis will automatically create groups for members based on material, orientation, length, and/or cross-section. Alternatively, Design Groups can be created or modified manually as explained in the [Groups Category](#).

## 6. Define the Parameters

For each Design Group, set the steel parameters (design specification, seismic compactness, overstrength, etc.) in the in the [Project Manager | Modify](#) tab in the Design View. Also, adjust the bracing, deflections, axial, size constraints, and overrides for the design group as needed.

## 8. Design the Group

After selecting a steel design group, click the Design the Group button in the Design ribbon. In the Design Selection dialog box, choose the search type (Database or Parametric) and set the number of shapes to be returned from the optimization. For a database search, choose which database is to be searched and the category of shapes that are to be searched within the database. Also, set the size constraints if needed. For a Parametric search, select the parametric type (I-Shape, Angle, Channel, etc.) and specify the search range (Start and End) and the Increment for each parameter of the shape or choose to hold the parameter constant. Once the search parameters are set, click the Optimize Now button to search for various sections and display the unit value for each shape. If a warning stating "demands could not be satisfied" appears, then all the shapes within the search parameters have a unity value larger than the Unity Success Limit defined in the Preferences. Enabling the Return all Shapes feature will provide information on every considered section which may be useful for determining why a section failed or was not optimal.

## 9. Select a Section

Once the optimization is complete, select a section from the list and click the Accept Design button. Now the unity value for all members in the design group are displayed using the selected section. The tilde symbol (~) in front of the unity value indicates that the unity checks must be validated with another analysis since the member stiffness and resulting load distribution may have changed.

## 10. Synchronize Design Changes

Click the Synchronize Design button in the Design ribbon to automatically update the model with the new cross-section, re-analysis the model with the new member stiffness, and rerun the design checks with the updated analysis results.

## 11. Verify Unity Ratios

The final step in the design process is to verify that Unity Ratios in the Design View are less than the Unity Success Limit defined in the Preferences. If member sizes were drastically changed during the design process, final unity ratios can differ from predicted unity ratios because the analysis results may vary significantly.

## Steel Reports

The steel design reports in VisualAnalysis are highly customizable. To control what is included in a report, simply click on a table in the report and adjust the settings in the [Project Manager | Selected Table](#) tab. The Extreme Rows feature is particularly useful to produce concise reports of only the controlling cases or to produce detailed reports that display every design check that is made. When this feature is set to Show All, the reports may become excessively large which can be controlled by adjusting the Conciseness feature. The reports for steel design include both a summary of the parameters input for the Design Group and tables that included the various design checks. These tables have the following columns:

<b>Column Name</b>	<b>Description</b>
Member	The member's name.

Column Name	Description
Section	The member's cross-section (e.g. W8x10).
Offset	This is the distance from the 'start' end of the member. The number and locations of offsets are as defined in the performance settings in VisualAnalysis.
Result Case	The result case that is used for the design check.
Demand/Capacity	These columns varies depending on the type of design check. In most cases these values are used directly in the unity check, but there are some special cases where the unity checks also include intermediate values or other values that not reported.
Code Reference	The controlling equations or provisions from the chosen design specification. For example, "F1-8" refers to the equation in the specification while a code reference like "AE3-3" refers to equation (A-E3-3) in Appendix E of the manual.
Unity Check	The unity check value for this particular member, load case, and offset. Unity checks are calculated as the absolute value of an actual force divided by an allowable strength [ASD] or as the ultimate force (factored) divided by the design strength (factored) [LRFD].
Details	Intermediate values and other information which can be helpful for validating results.

## Assumptions and Limitations

- **Design Forces** - All forces and moments are assumed to act about the principal axes of a member's cross-section. Shear loads are assumed to pass through the shear center so that torsion is not generated from the shear load. Axial loads are assumed to pass through the centroid of a member so that moments not generated from the axial load for the first order analysis.
- **Steel 'h' Approximation** - 'h' is defined as the clear distance between flanges less the fillet or corner radii. The following equation is used to approximate the value for 'h' if a shape is not in the shape database or does not store the k dimension:  $h = D - 3*tf$ .
- **Span Length Assumptions** - VisualAnalysis looks at a member-element's length to determine the span length which in turn affects unbraced length. For a Merged Member this is the total length of the member, regardless of internal nodes or connecting elements. For members designed according to the AISC specifications, this might also effect the determination of  $C_b$ . For members designed according to CSA specifications, this might effect the determination of  $\omega_2$  and  $\kappa$ . If the member's span is longer than the element span, consider using the Merge Member feature to help make the design software smarter. Alternately, you can specify an unbraced length directly or override the calculated values for  $C_b$ .
- **Tapered Members** - Tapered members are checked as prismatic members based on the properties at the start of the member.
- **Custom Shapes** - VisualAnalysis will not perform design checks for built-up shapes (e.g. channels connected to wide flanges) or for shapes that do not fall into the standard AISC or CSA categories (W-shape, angle, channel, etc.). There are also limits on member dimensions. For example, deep beams (plate girders) are not checked for design. For non-standard shapes, use the [stress check](#) feature to get preliminary checks from VisualAnalysis. [IES ShapeBuilder](#) can be used to get stress distributions on more complex shapes.
- **CSA Limitations** - Since the CSA design specification does not provide flexural design information for Tee and Angle sections, VisualAnalysis design these section according to the AISC design specification. Class 4 shapes as defined in the CSA specification are not supported by VisualAnalysis for steel design checks. These shapes can, however, be designed using the AISI Cold-Formed steel design checks which is the case for any thin-walled/cold-formed shapes. The AISC definition for  $C_b$  is used instead of  $\omega_2$  used in the CSA specification (with a 2.5 limit).



- **AISC Limitations** - For round HSS members, VisualAnalysis does not calculate the distance from maximum to zero shear force (Lv). Therefore, Fcr is conservatively calculated using Equation G5-2b.

## Steel References

1. American Institute of Steel Construction (AISC), Specification for Structural Steel Buildings, ANSI/AISC 360-16. 2016 Edition.
2. American Institute of Steel Construction (AISC), Specification for Structural Steel Buildings, ANSI/AISC 360-10. 2010 Edition.
3. American Institute of Steel Construction (AISC), Specification for Structural Steel Buildings, ANSI/AISC 360-05. 2005 Edition.
4. CSA Group, Design of Steel Structures, CSA S16-14, 2014 Edition. ISBN 978-1-77139-355-3.

## 5.6 Generic Stress and Deflection Checks

**Requires: Advanced Level**

### Introduction

VisualAnalysis can design generic members (composed of any shape and any material) according to user specified stress and deflection limits. Generic members are designed for axial load, bending (strong axis and weak axis), combined axial and bending, and torsion. The maximum unity value (demand to capacity ratio) for the member is shown in both the Design View and in the Report View, allowing the user to quickly identify if the member is passing ( $unity \leq Unity\ Success\ Limit$ ) or failing ( $unity > Unity\ Success\ Limit$ ). In addition to checking the stress levels for generic members, VisualAnalysis can check the deflection limits for the members based on the deflection limits set by the user and the Deflection Check load combinations. The shapes for generic members can be manually adjusted in the **Project Manager | Modify** tab until a satisfactory design is reached or VisualAnalysis can automatically optimize the shape for the Design Group using the Design the Group button in the Design Ribbon. The Generic member design feature is intended to perform preliminary design checks for members that fall outside of the other design types (Concrete, Steel, Wood, etc.) and is not intended to be a comprehensive design tool.

### Auto-Stress Groups

VisualAnalysis can automatically create stress-check Design Groups for ungrouped members such as members with custom shapes, tapered members, or members with materials that are not supported by the other design checks. Enable the Auto-Stress Checks feature in the **Project Manager | Modify** tab when modify is set to Project Settings.

### Generic Design Parameters

Several parameters must be defined to design generic members in VisualAnalysis. The design parameters are set in the **Project Manager | Modify** tab when the Design View is selected. After creating a Design Group, choose one of the members that belongs to the group in the Design View to set up the Design Group's Parameters. Since the design parameters apply to all members in the Design Group, it is often best to choose the most conservative condition that applies to any member in the group.

- Generic**
- Specification Level** - The type of load combinations to be used for design checks, service (ASD) or strength (LRFD).
  - Overstrength?** - Causes the Design Group to be designed using overstrength load combinations.
  - Live Load Reduction** - If specified, design checks will only consider result cases with the matching live load reduction. Combinations with live load reduction can be created in the **Load Case Manger**.

**Disable Checks?** - Causes selected Design Group to be omitted from design checks. This feature can be used to speed up design checks and focus on targeted areas of larger models.

**Check Level** - Determines the level of detail reported from design checks. Options are: *To Failure* (Fastest), *Each Limit State*, and *All* (Slowest, but provides the most information).

<b>Axial</b>	<b>Perform Check</b> - Should checks be performed for this limit state?
<b>Strong Bending</b>	<b>Tension Limit</b> - The tension stress limit to use for the design checks. <b>Compression Limit</b> - The compression stress limit to use for the design checks.
<b>Weak Bending</b>	
<b>Axial + Bending</b>	
<b>Torsion</b>	<b>Perform Check</b> - Should checks be performed for this limit state? <b>Limit</b> - The torsion limit to use for the design checks.
<b>Deflections</b>	<b>Strong (dy)</b> - Specify the type of limit for beam deflections in the y-direction. Use Total to include the displacements of the nodes at each end of the element. <b>Weak (dz)</b> - Specify the type of limit for beam deflections in the z-direction. Use Total to include the displacements of the nodes at each end of the element.
<b>Size Constraints</b>	<b>Limit Depth/Width?</b> - Allows the design search to 'Fail' if the shape is outside the Min/Max range.

## Generic Member Design Process

To achieve an adequate design, the section for the members in a Design Group can be manually adjusted until all the design checks pass. Alternatively, the built in optimization feature in VisualAnalysis can be used to find an adequate shape for the members in a Design Group. The optimization feature can be used to search for adequate Database Shapes or to iterate through the parameters of a Standard Parametric shape until an acceptable shape is found.

### 1. Create the Members

In the Model View draw or create the members.

### 2. Support and Load the Members

Define support conditions for the model and apply the service level loads to the members. Set the load combinations in the Load Case Manager.

### 3. Specify the Parameters

Select a preliminary Database Shape or Standard Parametric Shape and set the material properties.

### 4. Analysis and Preliminary Design

VisualAnalysis will automatically analyze the model and perform the appropriate design checks. Simply click on the Results View tab to view the analysis results for the model or the Design View tab to see the design results.

### 5. Create/Modify Design Groups

VisualAnalysis will automatically create groups for generic members if the Auto-Stress Checks feature is enabled in the [Project Manager | Modify](#) tab. Alternatively, Design Groups can be created or modified manually as explained in the [Groups Category](#).

## 6. Define the Parameters

For each Design Group, set the generic parameters (design specification, overstrength, etc.) in the in the **Project Manager | Modify** tab in the Design View. Also, adjust the stress limits, deflections, size constraints, for the Design Group as needed.

## 8. Design the Group

After selecting a Generic Design Group, click the Design the Group button in the Design ribbon. In the Design Selection dialog box, choose the search type (Database or Parametric) and set the number of shapes to be returned from the optimization. For a database search, choose which database is to be searched and the category of shapes that are to be searched within the database. Also, set the size constraints if needed. For a Parametric search, select the parametric type (I-shape, Angle, Channel, etc.) and specify the search range (Start and End) and the Increment for each parameter of the shape or choose to hold the parameter constant. Once the search parameters are set, click the Optimize Now button to search for various sections and display the unit value for each shape. If a warning stating "demands could not be satisfied" appears, then all the shapes within the search parameters have a unity value larger than the Unity Success Limit defined in the Preferences. Enabling the Return all Shapes feature will provide information on every considered section which may be useful for determining why a section failed or was not optimal.

## 9. Select a Section

Once the optimization is complete, select a section from the list and click the Accept Design button. Now the unity value for all members in the Design Group are displayed using the selected section. The tilde symbol (~) in front of the unity value indicates that the unity checks must be validated with another analysis since the member stiffness and resulting load distribution may have changed.

## 10. Synchronize Design Changes

Click the Synchronize Design button in the Design ribbon to automatically update the model with the new cross-section, re-analysis the model with the new member stiffness, and rerun the design checks with the updated analysis results.

## 11. Verify Unity Ratios

The final step in the design process is to verify that Unity Ratios in the Design View are less than the Unity Success Limit defined in the Preferences. If member sizes were drastically changed during the design process, final unity ratios can differ from predicted unity ratios because the analysis results may vary significantly.

## Generic Design Reports

The generic design reports in VisualAnalysis are highly customizable. To control what is included in a report, simply click on a table in the report and adjust the settings in the **Project Manager | Selected Table** tab. The Extreme Rows feature is particularly useful to produce concise reports of only the controlling cases or to produce detailed reports that display every design check that is made. When this feature is set to Show All, the reports may become excessively large which can be controlled by adjusting the Conciseness feature. The reports for general design include both a summary of the parameters input for the Design Group and tables that included the various design checks. These tables have the following columns:

Column Name	Description
Member	The member's name.
Section	The member's cross-section (e.g. Angle 6x4x0.25).
Offset	This is the distance from the 'start' end of the member. The number and locations of offsets are as defined in the performance settings in VisualAnalysis.
Result Case	The result case that is used for the design check.
Demand/Capacity	These columns varies depending on the type of design check (axial, flexure, combined, etc.).

Column Name	Description
Code Reference	Since Generic Design do not reference an actual design specification, this column displays the limit that is checked (e.g. axial compression, axial tension, bending compression, etc.)
Unity Check	The unity check value for this particular member, load case, and offset. Unity checks are calculated as the absolute value of an actual stress divided by an allowable stress [ASD] or as the ultimate stress (factored) divided by the design stress (factored) [LRFD].
Details	Intermediate values and other information which can be helpful for validating results.

## Generic Assumptions and Limitations

- **Sign Convention** - Tensile stress is positive (+) while compressive stress is negative (-).
- **Axial Stress** - The axial force (P) is applied at the centroid of the cross section. Therefore, the axial stress ( $f_a$ ) is the axial force (P) divided by the area (A).
- **Bending Stress** - The bending stresses ( $f_{bz}$  and  $f_{by}$ ) are calculated and reported with respect to the local z-axis and y-axis, which are the principal axes for the cross-section. The bending stress ( $f_b$ ) is calculated as the moment (M) divided by the section modulus to the extreme fiber (S) .
- **Combined Axial and Bending Stress** - Axial and bending stresses at the extreme fibers are combined with a simple algebraic sum.
- **Shear Stress**- Shear stress limits are not considered for the members in Generic Design Groups.
- **Torsion Forces** - The maximum torsion in each member is checked against the specified torsion limit. Torsion stresses are not calculated for members in the Generic Design Group.

## 5.7 Aluminum Design

**Requires: Full Design Level**

### Introduction

VisualAnalysis designs aluminum members according to the following Aluminum Design Manual (ADM) specification produced by the Aluminum Association:

- ADM 2015 ASD & LRFD

Aluminum members are designed for tension, compression, flexure (strong axis and weak axis), shear, and torsion to resist the varying demands along the length of the member. When necessary, the interaction of these loads are accounted for in the design checks per the selected design specification. The maximum unity value (demand to capacity ratio) for the member is shown in both the Design View and in the Report View, allowing the user to quickly identify if the member is passing ( $unity \leq Unity\ Success\ Limit$ ) or failing ( $unity > Unity\ Success\ Limit$ ). In addition to checking the capacity for aluminum members, VisualAnalysis can check the deflection limits for the members based on the deflection limits set by the user and the Deflection Check load combinations. The shapes for aluminum members can be manually adjusted in the **Project Manager | Modify** tab until a satisfactory design is reached or VisualAnalysis can automatically optimize the shape for the Design Group using the Design the Group button in the Design Ribbon. Appropriate [load combinations](#) (Strength for LRFD, Allowable for ASD) must be used to obtain design checks.

### Aluminum Design Capabilities

#### Shape Types

VisualAnalysis can perform aluminum design using Database Shapes, Standard Parametric shapes, or custom shapes that have the required shape properties for design. For example, the ADM standard shapes in the IES Shape Database can all be designed according to the aforementioned ADM design specifications. The IES Shape Database can be customized to include libraries of custom, foreign, or legacy shapes. The following Standard Parametric shapes are supported by VisualAnalysis for aluminum design: angle, channel, circle, I-shape, pipe, rectangle, rectangular tube, tee and zee (spandrel shapes are not supported for aluminum design). Custom shapes can be created using [IES ShapeBuilder](#) and are supported for aluminum design in VisualAnalysis given the required shape properties.

## Torsion

The St. Venant torsional shear stress is calculated from the torsional moment and added to the shear stress calculated in VisualAnalysis. **Torsional Warping stresses are not considered.** Therefore, cross-sections that are not "closed shapes" are not fully checked if torsion is present. The maximum torsional moment can be reported to help the user check for other torsional stresses that may be present.

## Bracing

By default, the unbraced length for a member is assumed to be the member-element length between nodes. The lateral top/bottom unbraced length is used for the flexural design checks while the strong unbraced length is used for the compression design checks. See [Bracing](#) for more information on member bracing.

## Deflections

A variety of options are available to specify the deflection limits. To obtain deflection checks, deflection load combinations must be included in the in the Load Case Manager. More information is available on the [Deflections Page](#).

## Aluminum Parameters

Several parameters must be defined to design aluminum members in VisualAnalysis. The design parameters are set in the [Project Manager | Modify](#) tab when the Design View is selected. After creating a Design Group, choose one of the members that belongs to the group in the Design View to set up the Design Group's Parameters. Since the design parameters apply to all members in the Design Group, it is often best to choose the most conservative condition that applies to any member in the group.

**Aluminum Specification** - The Design Specification used to design the members in the Design Group.

**Bridge-Type Structure** - Choose to use bridge type  $\phi$  and/or  $\Omega$  factors.

**Heat Affected?** - Specify if the members should be designed with the heat-affected 'w' values (heat-affected members are usually welded). Select Partial Length to specify the portion of member length at each end to use the welded material properties. Design checks are performed with  $F_{tyw}$ ,  $F_{tuw}$ ,  $F_{cyw}$ ,  $F_{suw}$  stress values in the heat affected zones.

**Overstrength?** - Causes the Design Group to be designed using overstrength load combinations.

**Live Load Reduction** - If specified, design checks will only consider result cases with the matching live load reduction. Combinations with live load reduction can be created in the [Load Case Manger](#).

**Disable Checks?** - Causes selected Design Group to be omitted from design checks. This feature can be used to speed up design checks and focus on targeted areas of larger models.

**Check Level** - Determines the level of detail reported from design checks. Options are: *To Failure* (Fastest), *Each Limit State*, and *All* (Slowest, but provides the most information).

**Bracing Lateral Top (+y)** - Lateral bracing at the top side of the member (+y). Choose a bracing arrangement.

**Lateral Bottom (-y)** - Lateral bracing at the bottom side of the member (-y). Choose a bracing arrangement.

**Strong (z)** - Brace against strong-axis buckling for columns.

**Deflections Strong (dy)** - Specify the type of limit for beam deflections in the y-direction. Use Total to include the displacements of the nodes at each end of the element.

**Weak (dz)** - Specify the type of limit for beam deflections in the z-direction. Use Total to include the displacements of the nodes at each end of the element.

**Size Constraints Limit Depth/Width?** - Allows the design search to 'Fail' if the shape is outside the Min/Max range.

**Axial Manual  $K_z/K_y$**  - Allows the user to manually override the effective length factors for the strong/weak axis.

**$K_z/K_y$  Sidesway?** - Choose if the member is apart of a sway frame in the specified direction.

**Overrides Override Cb?** - Disable the automatic determination of Cb and allows a custom value to be used.

**Override Fty, Ftu, Fcy, Fsu?** - Override the stress parameters used for the design and unity checks. The value of Fsy will be affected by Fty. These overrides only affect the portions of the members that are not Heat Affected.

**Override Ftyw, Ftuw, Fcyw, Fsuw?** - Override the stress parameters used for the heat affected sections for design and unity checks. These overrides only affect the portions of the members that are Heat Affected.

## Aluminum Member Design Process

To achieve an adequate design, the section for the members in a Design Group can be manually adjusted until all the design checks pass. Alternatively, the built in optimization feature in VisualAnalysis can be used to find an adequate shape for the members in a Design Group. The optimization feature can be used to search for adequate Database Shapes or to iterate through the parameters of a Standard Parametric shape until an adequate shape is found.

### 1. Create the Members

In the Model View draw or create the Aluminum members.

### 2. Support and Load the Members

Define support conditions for the model and apply the service level loads to the members. Set the load combinations in the Load Case Manager.

### 3. Specify the Parameters

Select a preliminary Aluminum Database Shape or Standard Parametric Shape and set the material properties.

### 4. Analysis and Preliminary Design

VisualAnalysis will automatically analyze the model and perform the appropriate design checks. Simply click on the Results View tab to view the analysis results for the model or the Design View tab to see the design results.

### 5. Create/Modify Design Groups

VisualAnalysis will automatically create groups for members based on material, orientation, length, and/or cross-section. Alternatively, Design Groups can be created or modified manually as explained in the [Groups Category](#).

### 6. Define the Parameters

For each Design Group, set the Aluminum parameters (design specification, structure type, heat affected regions, etc.) in the in the **Project Manager | Modify** tab in the Design View. Also, adjust the bracing, deflections, size constraints, axial, and overrides for the design group as needed.

## 8. Design the Group

After selecting a Aluminum design group, click the Design the Group button in the Design ribbon. In the Design Selection dialog box, choose the search type (Database or Parametric) and set the number of shapes to be returned from the optimization. For a database search, choose which database is to be searched and the category of shapes that are to be searched within the database. Also, set the size constraints if needed. For a Parametric search, select the parametric type (I-Shape, Angle, Channel, etc.) and specify the search range (Start and End) and the Increment for each parameter of the shape or choose to hold the parameter constant. Once the search parameters are set, click the Optimize Now button to search for various sections and display the unit value for each shape. If a warning stating "demands could not be satisfied" appears, then all the shapes within the search parameters have a unity value larger than the Unity Success Limit defined in the Preferences. Enabling the Return all Shapes feature will provide information on every considered section which may be useful for determining why a section failed or was not optimal.

## 9. Select a Section

Once the optimization is complete, select a section from the list and click the Accept Design button. Now the unity value for all members in the design group are displayed using the selected section. The tilde symbol (~) in front of the unity value indicates that the unity checks must be validated with another analysis since the member stiffness and resulting load distribution may have changed.

## 10. Synchronize Design Changes

Click the Synchronize Design button in the Design ribbon to automatically update the model with the new cross-section, re-analysis the model with the new member stiffness, and rerun the design checks with the updated analysis results.

## 11. Verify Unity Ratios

The final step in the design process is to verify that Unity Ratios in the Design View are less than the Unity Success Limit defined in the Preferences. If member sizes were drastically changed during the design process, final unity ratios can differ from predicted unity ratios because the analysis results may vary significantly.

## Aluminum Reports

The aluminum design reports in VisualAnalysis are highly customizable. To control what is included in a report, simply click on a table in the report and adjust the settings in the **Project Manager | Selected Table** tab. The Extreme Rows feature is particularly useful to produce concise reports of only the controlling cases or to produce detailed reports that display every design check that is made. When this feature is set to Show All, the reports may become excessively large which can be controlled by adjusting the Conciseness feature. The reports for aluminum design include both a summary of the parameters input for the Design Group and tables that included the various design checks. These tables have the following columns:

Column Name	Description
Member	The member's name.
Section	The member's cross-section (e.g. C5x3.55).
Offset	This is the distance from the 'start' end of the member. The number and locations of offsets are as defined in the performance settings in VisualAnalysis.
Result Case	The result case that is used for the design check.

Column Name	Description
Demand/Capacity	These columns varies depending on the type of design check. In most cases these values are used directly in the unity check, but there are some special cases where the unity checks also include intermediate values or other values that not reported.
Code Reference	The controlling equations or provisions from the chosen design specification. For example, "G.2-1" refers to the equation in the specification while "F.4" refers to a section in the code.
Unity Check	The unity check value for this particular member, load case, and offset. Unity checks are calculated as the absolute value of an actual force divided by an allowable strength [ASD] or as the ultimate force (factored) divided by the design strength (factored) [LRFD].
Details	Intermediate values and other information which can be helpful for validating results.

## Assumptions and Limitations

### General

- **Design Forces** - All forces and moments are assumed to act about the principal axes of a member's cross-section. Shear loads are assumed to pass through the shear center so that torsion is not generated from the shear load. Axial loads are assumed to pass through the centroid of a member so that moments not generated from the axial load for the first order analysis.
- **Span Length Assumptions** - VisualAnalysis looks at a member-element's length to determine the span length which in turn affects unbraced length. For a Merged Member this is the total length of the member, regardless of internal nodes or connecting elements. For members designed according to the ADM specifications, this might also effect the determination of  $C_b$ . If the member's span is longer than the element span, consider using the Merge Member feature to help make the design software smarter. Alternately, you can specify an unbraced length directly or override the calculated values for  $C_b$ .
- **Tapered Members** - Tapered members are checked as prismatic members based on the properties at the start of the member.
- **Custom Shapes** - VisualAnalysis will not perform design checks for built-up shapes (e.g. channels connected to wide flanges) or for shapes that do not fall into the standard ADM categories (I, C, Z, L, etc). Custom extrusions or other complex shapes are not supported. There are also limits on member dimensions. For example, deep beams (plate girders) are not checked for design. For non-standard shapes, use the [stress check](#) feature to get preliminary checks from VisualAnalysis. [IES ShapeBuilder](#) can be used to get stress distributions on more complex shapes.
- **Deflection Checks** - Deflection checks are made using the gross-section of the shape, no reduction is taken for effective widths according to ADM section L.3.

### Specification

- Stability requirements of Chapter C are not implemented.
- The entire cross-section of members specified as "Heat Affected" (welded) is assumed to be affected. Reduced stress values are used for all limit states.
- G.2 is assumed to provide  $F_s$  for one edge supported shear (weak axis in most cases) as well as both edges supported.  $B$  is assumed to be clear distance from face of web to tip of flange.
- Solid shapes are assumed to have  $F_s = F_{sy}$ . Mechanics equations  $3V/2A$ ,  $4V/3A$  are used for stress calculations.
- Pipe Shape shear strength is based on Equation G.4-4 with the  $L_v$  parameter conservatively taken as the entire member length.



- B.5.4.1 Local Buckling strength for singly symmetric sections is based on elastic buckling strength. The allowed increase for Post buckling of singly symmetric sections buckling globally about the strong axis is not utilized.
- Code provisions for Torsional and Flexural-Torsional Buckling (E.2.2) are applied to all shapes without exception. This may lead to smaller capacities than if this provision is omitted such as in Example 9 on page VII-18 (I-Beam in Axial Compression).
- The provisions of F.3 are implemented using the weighted average flexural strength per section F.3.1.
- Single angles are always assumed to be bent about principal axes. Local buckling checks are made per F.5.a.1. Local buckling checks per F.5.a.2 (the case of an angle leg in uniform compression bent about the geometric axes) is not considered.
- Torsion is checked per chapter H.2. Torsion checks for open shapes do not consider normal stresses due to warping. Therefore, the results for open shapes should be checked carefully since open shapes are subject to warping stresses due to torsion.
- A conservative approach to ADM H.3 is taken: VisualAnalysis assumes that the maximum flexural shear stress, normal bending stress, and torsional shear stress all occur at the same point on the cross section and that these can all be superimposed with the axial stress. They are combined per interaction equations H.3-1 thru H.3-4.

## Aluminum References

1. Aluminum Association, Aluminum Design Manual, ADM-2015. 2015 Edition. ISBN 978-0986363108
2. J.R. Kissel, R.L.Ferry, Aluminum Structures: A Guide to Their Specifications and Design. 2nd Edition. John Wiley & Sons, Inc. 2002. ISBN 0-471-01965-8

## 5.8 Cold Formed Steel Design

**Requires: Full Design Level**

### Introduction

VisualAnalysis performs the design of light-gauge cold-formed steel members (beams, columns, braces, wall components, headers, etc.) according to the following design specifications:

- AISI 2018, US ASD & LRFD
- AISI 2018, Mexico ASD & LRFD
- AISI 2018, Canada LSD
- AISI 2016, US ASD & LRFD
- AISI 2016, Mexico ASD & LRFD
- AISI 2016, Canada LSD
- AISI 2012, US ASD & LRFD
- AISI 2012, Mexico ASD & LRFD
- AISI 2012, Canada LSD
- AISI 2010, US ASD & LRFD
- AISI 2010, Mexico ASD & LRFD
- AISI 2010, Canada LSD

Cold-formed members in VisualAnalysis are designed with a built-in version of [CFS by RSG Software, Inc.](#) Listed below is the version of CFS that is used within VisualAnalysis.

# VisualAnalysis 19 User's Guide

VisualAnalysis 19 references RSG Software, CFS 12.0

VA18

VisualAnalysis 18 references RSG Software, CFS 10.0

VA17

VisualAnalysis 17 references RSG Software, CFS 10.0

Cold-formed members are designed for flexure (strong axis and weak axis), shear, tension, and compression to resist the varying demands along the length of the member. When necessary, the interaction of these loads are accounted for in the design checks per the selected design specification. The maximum unity value (demand to capacity ratio) for the member is shown in both the Design View and in the Report View, allowing the user to quickly identify if the member is passing (unity  $\leq$  Unity Success Limit) or failing (unity  $>$  Unity Success Limit). In addition to checking the capacity for cold-formed members, VisualAnalysis can check the deflection limits for the members based on the deflection limits set by the user and the Deflection Check load combinations. The shapes for cold-formed members can be manually adjusted in the **Project Manager | Modify** tab until a satisfactory design is reached or VisualAnalysis can automatically optimize the shape for the Design Group using the Design the Group button in the Design Ribbon.

## Custom Cold-Formed Shapes

VisualAnalysis can design custom cold-formed shapes that are not originally included in the IES Shape Database. The shapes must be defined in a .scl or .cfsl file, which is a shape library file produced by the CFS program from [RSG Software](#). The .scl or .cfsl file can be imported directly into the database using the **File | Import | Import Cold Formed Library**. These custom shape library files need to be stored in specific locations with other [IES data](#) in order for VisualAnalysis to find and use the files.

## Flexure, Shear, and Axial Load Design

VisualAnalysis designs cold-formed members for flexure (strong axis and weak axis), shear, and axial load (tensions and compression) according to the provisions outlined in the chosen design specification. All member forces are with respect to the member's principle axes which may not align with the geometric axes (as is the case for asymmetric shapes like single angles). When the model is sufficiently supported, loaded, and has the appropriate load combinations, the cold-formed design checks are performed automatically. When necessary, members are checked for interaction of the combined loads according to the chosen design specification.

## 2010 & 2012 Design Specifications

### Combined Axial & Bending Check – Equation 1

- ASD Tension/Bending AISI C5.1.1-1
- LRFD & LSD Tension/Bending AISI C5.1.2-1
- ASD Compression/Bending AISI C5.2.1-1
- LRFD & LSD Compression/Bending AISI C5.2.2-1

### **Combined Axial & Bending Check – Equation 2**

- ASD Tension/Bending AISI C5.1.1-2
- LRFD & LSD Tension/Bending AISI C5.1.2-2
- ASD Compression/Bending AISI C5.2.1-2
- LRFD & LSD Compression/Bending AISI C5.2.2-2

### **Combined Shear & Bending Check**

- ASD AISI C3.3.1-1
- LRFD & LSD AISI C3.3.2-1

## 2016 & 2018 Design Specifications

- **Combined Axial & Bending Check – Equation 1**
  - ASD, LRFD, & LSD Tension/Bending AISI H1.1-1
  - ASD, LRFD, & LSD Compression/Bending AISI H1.2-1
- **Combined Axial & Bending Check – Equation 2**
  - ASD, LRFD, & LSD Tension/Bending AISI H1.1-2
  - ASD, LRFD, & LSD Compression/Bending AISI H1.2-1
- **Combined Shear & Bending Check**
  - ASD & LRFD AISI H2-1

## Cold-Formed Design Parameters

Several parameters must be defined to design cold-formed members in VisualAnalysis. The design parameters are set in the [Project Manager | Modify](#) tab when the Design View is selected. After creating a Design Group, choose one of the members that belongs to the group in the Design View to set up the Design Group's Parameters. Since the design parameters apply to all members in the Design Group, it is often best to choose the most conservative condition that applies to any member in the group.

### **Cold-Formed**

**Specification** - The Design Specification used to design the members in the Design Group.

**Strength Increase?** - Allows higher stress values due to strain hardening effects in cold-worked steel.

**Overstrength?** - Causes the Design Group to be designed using overstrength load combinations.

**Live Load Reduction** - If specified, design checks will only consider result cases with the matching live load reduction. Combinations with live load reduction can be created in the [Load Case Manger](#).

**Disable Checks?** - Causes selected Design Group to be omitted from design checks. This feature can be used to speed up design checks and focus on targeted areas of larger models.

**Check Level** - Determines the level of detail reported from design checks. Options are: *To Failure* (Fastest), *Each Limit State*, and *All* (Slowest, but provides the most information).

### **Bracing**

**Lateral Top (+y)** - Lateral bracing at the top side of the member (+y). Choose a bracing arrangement.

**Lateral Bottom (-y)** - Lateral bracing at the bottom side of the member (-y). Choose a bracing arrangement.

**Strong (z)** - Brace against strong-axis buckling for columns.

<b>Torsional Bracing</b>	<b>Lateral Top (+y)</b> - Do the specified braces on the top side of the member (+y) provide torsional restraint? This is used to determine the Torsional Unbraced Length. <b>Lateral Bottom (-y)</b> - Do the specified braces on the bottom side of the member (-y) provide torsional restraint? This is used to determine the Torsional Unbraced Length. <b>Strong (z)</b> - Do the specified braces for strong-axis buckling provide torsional restraint? This is used to determine the Torsional Unbraced Length.
<b>Deflections</b>	<b>Strong (dy)</b> - Specify the type of limit for beam deflections in the y-direction. Use Total to include the displacements of the nodes at each end of the element. <b>Weak (dz)</b> - Specify the type of limit for beam deflections in the z-direction. Use Total to include the displacements of the nodes at each end of the element.
<b>Axial</b>	<b>Manual <math>K_z/K_y</math></b> - Allows the user to manually override the effective length factors for the strong/weak axis. <b><math>K_z/K_y</math> Sidesway?</b> - Choose if the member is apart of a sway frame in the specified direction.
<b>Size Constraints</b>	<b>Limit Depth/Width?</b> - Allows the design search to 'Fail' if the shape is outside the Min/Max range.
<b>Overrides</b>	<b>Override <math>C_b</math>?</b> - Disable the automatic determination of $C_b$ and allows a custom value to be used. <b>Override <math>C_m</math>?</b> - Disable the automatic determination of $C_m$ and allows a custom value to be used.

## Cold-Formed Member Design Process

To achieve an adequate design, the section for the members in a Design Group can be manually chosen from the Database until all the design checks pass. Alternatively, the built in optimization feature in VisualAnalysis can be used to find an adequate shape for the members in a Design Group. The optimization feature can be used to search for adequate Database Shapes until an adequate shape is found.

### 1. Create the Members

In the Model View draw or create the cold-formed members.

### 2. Support and Load the Members

Define support conditions for the model and apply the service level loads to the members. Set the load combinations in the Load Case Manager.

### 3. Specify the Parameters

Select a preliminary cold-formed Database Shape or Standard Parametric Shape and set the material properties.

### 4. Analysis and Preliminary Design

VisualAnalysis will automatically analyze the model and perform the appropriate design checks. Simply click on the Results View tab to view the analysis results for the model or the Design View tab to see the design results.

### 5. Create/Modify Design Groups

VisualAnalysis will automatically create groups for members based on material, orientation, length, and/or cross-section. Alternatively, Design Groups can be created or modified manually as explained in the [Groups Category](#).

### 6. Define the Parameters

For each Design Group, set the cold-formed parameters (design specification, strength increase, overstrength, etc.) in the in the [Project Manager | Modify](#) tab in the Design View. Also, adjust the bracing, deflections, axial, size constraints, and

overrides for the design group as needed.

## 8. Design the Group

After selecting a cold-formed design group, click the Design the Group button in the Design ribbon. In the Design Selection dialog box, choose the Database search type and set the number of shapes to be returned from the optimization. Choose which database is to be searched and the category of shapes that are to be searched within the database. Also, set the size constraints if needed. Parametric shapes are not supported for cold-formed design. Once the search parameters are set, click the Optimize Now button to search for various sections and display the unit value for each shape. If a warning stating "demands could not be satisfied" appears, then all the shapes within the search parameters have a unity value larger than the Unity Success Limit defined in the Preferences. Enabling the Return all Shapes feature will provide information on every considered section which may be useful for determining why a section failed or was not optimal.

## 9. Select a Section

Once the optimization is complete, select a section from the list and click the Accept Design button. Now the unity value for all members in the design group are displayed using the selected section. The tilde symbol (~) in front of the unity value indicates that the unity checks must be validated with another analysis since the member stiffness and resulting load distribution may have changed.

## 10. Synchronize Design Changes

Click the Synchronize Design button in the Design ribbon to automatically update the model with the new cross-section, re-analysis the model with the new member stiffness, and rerun the design checks with the updated analysis results.

## 11. Verify Unity Ratios

The final step in the design process is to verify that Unity Ratios in the Design View are less than the Unity Success Limit defined in the Preferences. If member sizes were drastically changed during the design process, final unity ratios can differ from predicted unity ratios because the analysis results may vary significantly.

## Cold-Formed Reports

The cold-formed design reports in VisualAnalysis are highly customizable. To control what is included in a report, simply click on a table in the report and adjust the settings in the **Project Manager | Selected Table** tab. The Extreme Rows feature is particularly useful to produce concise reports of only the controlling cases or to produce detailed reports that display every design check that is made. When this feature is set to Show All, the reports may become excessively large which can be controlled by adjusting the Conciseness feature. The reports for cold-formed design include both a summary of the parameters input for the Design Group and tables that included the various design checks. These tables have the following columns:

Column Name	Description
Member	The member's name.
Section	The member's cross-section (e.g. 10x2.0C12).
Offset	This is the distance from the 'start' end of the member. The number and locations of offsets are as defined in the performance settings in VisualAnalysis.
Result Case	The result case that is used for the design check.
Demand/Capacity	These columns varies depending on the type of design check. In most cases these values are used directly in the unity check, but there are some special cases where the unity checks also include intermediate values or other values that not reported.
Code Reference	The controlling equations or provisions from the chosen design specification.

# VisualAnalysis 19 User's Guide

Column Name	Description
Unity Check	The unity check value for this particular member, load case, and offset. Unity checks are calculated as the absolute value of an actual force divided by an allowable strength [ASD] or as the ultimate force (factored) divided by the design strength (factored) [LRFD].
Details	Intermediate values and other information which can be helpful for validating results.

## Assumptions and Limitations

- Carbon steel materials are assumed to comply with the 'Applicable Steels' listed in the AISI design specification.  $E = 29,500$  ksi during design checks.
- The effects of holes are ignored for shear strength calculations.
- Design checks assume there are no shear stiffeners.
- Lateral braces are assumed to comply with AISI requirements.
- For sections that have web holes, the holes are assumed to be circular.
- For elements with holes under a stress gradient, the effective width is determined by treating the elements adjacent to the hole as unstiffened elements.
- When a member is used as part of a stud wall system, the design check does not include the strength contribution of the sheathing.
- Web-crippling checks are not performed.
- Connections are not designed or checked.
- Checks are limited to shapes found in the IES Shape Database that are also associated with a .scl or .cfs shape library file.
- Currently there is no way to "double-up" members. You may either model and check the members independently, or you will need to provide custom member shapes for the IES shape database.
- For 2010 specifications,  $L_m$  (distortional brace length) is conservatively assumed to be 240 inches (there is no way to set this value in VisualAnalysis).
- Stainless steel is currently not supported for cold-formed design in VisualAnalysis even though the CFS program has this feature.

## References

1. American Iron and Steel Institute, Cold-Formed Steel Design Manual, various editions.
2. RSG Software, Inc., 2803 NW Chipman Road, Lee's Summit, MO 64081. Mr. Bob Glauz, owner. IES licenses the CFS 'engine' from RSG Software for cold-form checks. The full CFS product is available for purchase at [www.rsgsoftware.com](http://www.rsgsoftware.com). For more advanced uses such as creating library files for new shapes to be added to the database, contact RSG at [info@rsgsoftware.com](mailto:info@rsgsoftware.com) or 816-524-5596.

## 5.9 Composite Steel Beam Design

**Requires: 2D Design Level**

### Introduction

VisualAnalysis performs the design of composite steel beams according to the following design specifications:

- AISC 360-16 ASD & LRFD

- AISC 360-10 ASD & LRFD
- AISC 360-05 ASD & LRFD

Composite steel beams design is based on the [Steel Design](#) provisions. When a steel design group is marked as composite beam, sections for the concrete slab, deck, and studs appear in the **Project Manager | Modify** tab to specify the additional parameters required for the composite beam member.

The construction type for composite beams can be set as Shored, Unshored (Approximate), or Unshored (User Defined). When specified as Unshored, the non-composite flexural capacity of the beam is checked for the construction loading. In addition to checking the flexural capacity for composite steel beams, VisualAnalysis can check the deflection limits for the composite members based on the deflection limits set by the user and the Deflection Check load combinations. Composite steel beam deflections are determined using the lower bound moment of inertia as described in the AISC specification. The maximum unity value (demand to capacity ratio) for the member is shown in both the Design View and in the Report View, allowing the user to quickly identify if the member is passing ( $\text{unity} \leq \text{Unity Success Limit}$ ) or failing ( $\text{unity} > \text{Unity Success Limit}$ ).

## Modeling for Design

To effectively use VisualAnalysis to design composite beam members, only the steel member should be modeled. The stiffness from the concrete slab or from member offsets should not be included in the model as these will be automatically accounted for in the design checks. Note: Engineering judgment should be used to determine if modeling the members without the composite action stiffness is valid for the specific situation.

## Composite Steel Design Parameters

Several additional parameters must be defined to design composite steel beams in VisualAnalysis. The design parameters are set in the **Project Manager | Modify** tab when the Design View is selected. After creating a Design Group, choose one of the members that belongs to the group in the Design View to set up the Design Group's Parameters. Since the design parameters apply to all members in the Design Group, it is often best to choose the most conservative condition that applies to any member in the group. The following parameters must be defined in for composite beams in addition to the [Steel Design Parameters](#).

**Bracing (Pre-Composite)**     **Lateral Top (+y)** - Lateral bracing at the top side of the member (+y) for the pre-composite condition. Choose a bracing arrangement. (Only Applies to Unshored Construction types)

**Lateral Bottom (-y)** - Lateral bracing at the bottom side of the member (-y) for the pre-composite condition. Choose a bracing arrangement. (Only Applies to Unshored Construction types)

**Concrete Slab**     **Construction Type** - Define the pre-composite demands (strength and deflection) for the beam-slab system.

- Shored: The beam is continuously shored during construction resulting in no pre-composite demands.
- Unshored (Approximate): Calculate the pre-composite demands using a simple-span beam model loaded uniformly by the weight of the beam, slab, and deck.
- Unshored (Defined Loads): Use the analysis results from load combinations marked as 'Construction' to determine pre-composite demands.

**Strength,  $f'c$**  - Specifies the 28-day compressive strength of the concrete.

**Thickness** - Specifies the slab height, as measured from the top of the slab to the top of the steel beam.

**Weight** - Selects from typical concrete unit weights. Lightweight concrete may reduce shear stud capacity.

**Beam Spacing** - Defines the distance between adjacent beams. The effective slab width is based on this value. Conservatively use the smallest applicable distance.

**Is Spandrel?** - If members in the group are spandrel beams (at the edge of the slab), check this box and enter the slab overhang.

**Deck and Anchors** - **Anchors** - The anchor parameters (type,  $F_u$ , length, distance from stud to deck web, and number of rows) and spacing regions (member divisions and spacing for each division) are specified in the Steel Anchor Parameters dialog box.

**Deck Type** - Specify whether or not there is a metal deck and the deck's orientation. This setting affects shear stud capacities, size, and spacing requirements. When the deck type is set to parallel or perpendicular ribs, a deck profile can be selected from the database or the rib height, rib width, rib spacing, and deck weight can be manually entered.

## Construction Type

The Construction Type is used to define the pre-composite demands (strength and deflection) for the beam-slab system. The Construction Type for the Design Group is set in the Concrete Slab section of the **Project Manager | Modify** tab. The Construction Type can be set to Shored, Unshored (Approximate), or Unshored (Defined Loads). The following table summarizes the capabilities and limitations of each Construction Type.

	Shored	Unshored (Approximate)	Unshored (Defined Loads)
<b>Pre-Composite Strength Checked</b>	No	Yes	Yes
<b>Pre-Composite Deflection Checked</b>	No	Yes	Yes
<b>Composite Strength Checked</b>	Yes	Yes	Yes
<b>Composite Deflection Checked</b>	Yes	Yes	Yes
<b>Requires Construction Load Combinations</b>	No	No	Yes
<b>Simple Span Assumption</b>	No	Yes	No
<b>Uniform Dead Load Assumption</b>	No	Yes	No

### Shored

For the Shored Construction Type, the beam is assumed to be continuously shored during construction resulting in no pre-composite demands. Therefore, no permanent pre-composite deflections exist and the pre-composite capacity of the member is not checked. For this case, the non-construction loads (Dead, Live, etc.) should be applied to the system (e.g. the loads that the beam-slab system will experience after the concrete deck has cured, the shoring is removed, and the beam and slab act as a composite or partial-composite system). Construction Load Combinations are not needed for the Shored Construction Type.

### Unshored (Approximate)

For the Unshored (Approximate) Construction Type, the pre-composite demands (strength and deflections) are automatically calculated and checked in VisualAnalysis using an assumed simple-span beam model loaded uniformly by



the self-weight of the beam, the weight of the concrete deck, and the weight of the permanent metal deck form (if any). Note: These assumptions may or may not match the analysis model and it is up to the user to decide if the assumptions are valid for their particular case. The pre-composite capacity checks are automatically made using the 1.4D LRFD or 1.0D ASD load combination depending on the chosen design specification. The permanent pre-composite deflection limits are automatically checked when the deflection design parameters are specified. For the Unshored (Approximate) Construction Type, the non-construction loads (Dead, Live, etc.) should be applied to the system (e.g. the loads that the beam-slab system will experience after the concrete deck has cured, the shoring is removed, and the beam and slab act as a composite or partial-composite system). The non-construction dead load should include the self-weight of the beam, the weight of the concrete slab, the weight of any permanent deck forms in addition to any other dead loads on the system. The capacity and deflection limits of the composite or partial-composite system are checked for the specified Strength and Deflection load combinations in the Load Case Manager. Construction Load Combinations are not needed for the Unshored (Approximate) Construction Type. VisualAnalysis automatically accounts for the permanent pre-composite deflection in the composite deflection checks.

## Unshored (Defined Load)

For the Unshored (Defined Load) Construction Type, the analysis results from the load combinations marked as 'Construction' are used to determine the pre-construction demands on the beam. Creating construction load service cases allows the Construction Strength and Deflection load combinations to be easily defined. The non-composite strength of the steel beam is checked to ensure that it can support the demands from the Construction Strength Load Combinations. The pre-composite deflection limits are checked using the stiffness of the non-composite steel beam for each Construction Deflection Load Combination and the permanent pre-composite deflections are calculated using the Construction Deflection Load Combinations that only have loads from a Dead Load source. The dead load in the non-construction Strength Load Combinations should include the self-weight of the beam, the weight of the concrete slab, the weight of any permanent deck forms in addition to any other dead loads on the system. The dead load in the non-construction Deflection Load Combinations should not include the self-weight of the beam, the weight of the concrete slab, or the weight of the permanent deck forms (i.e. only include dead load that was not included in the construction load cases) since the permanent pre-composite deflection is automatically added to the composite deflection.

## Beam Bracing

### Pre-Composite (Construction) Beam Bracing

When the Construction Type is set to Unshored (Approximate or Defined Loads), the lateral bracing at both the top and bottom of the member can be specified for the pre-composite condition. When the Construction Type is set to Shored, VisualAnalysis assumes the beam is fully shored and does not perform any pre-composite checks. Consequently, no pre-composite bracing parameters are required for the shored construction case.

### Composite Beam Bracing

The concrete deck is assumed to continuously brace the top flange of the beam for the composite condition. The bottom flange of the beam is assumed to be unbraced and the unbraced length is assumed to equal the member's length.

## Steel Anchor Layout

Composite beams can be divided into multiple regions and the steel anchor spacing can be defined for each region as shown in the image below. Steel anchors are placed at the start of a region (i.e. the region's side closest to the start of a beam) and spaced equally until the next region is reached. Since the number of rows,  $N_r$ , is specified for the entire member, it cannot vary for the different regions of a member.

## Example Steel Anchor Layout (3 Regions, Nr = 2)

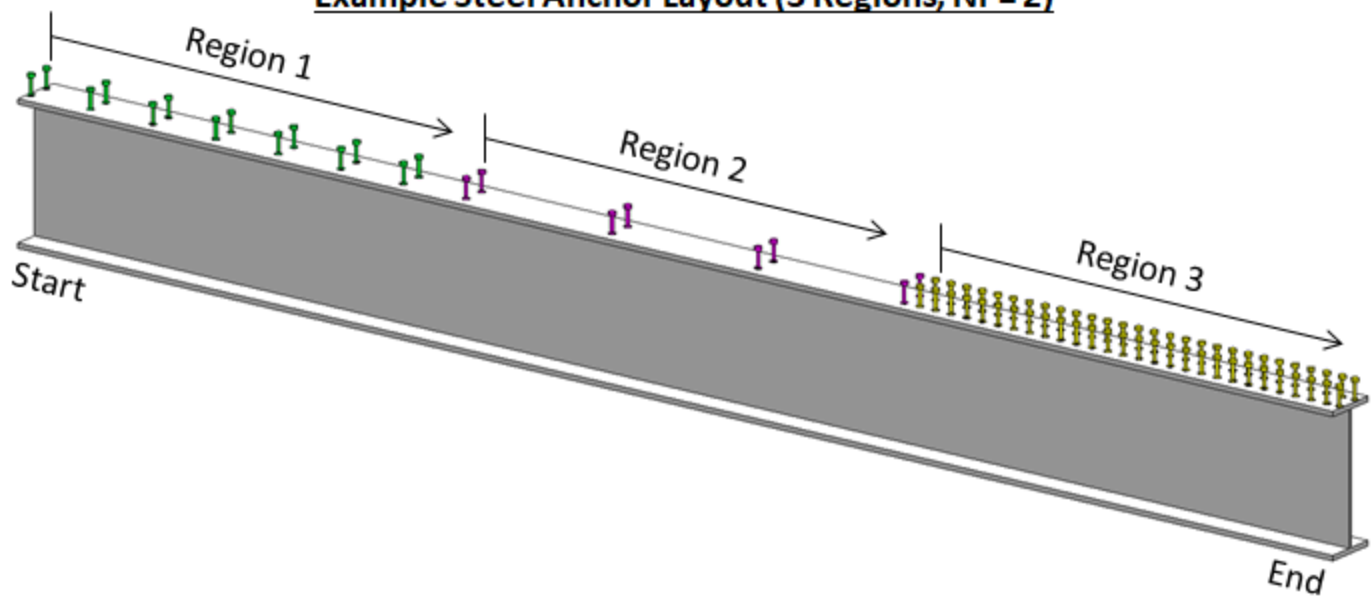

### Beam Flexural Capacity

The flexural capacity for both the pre-composite beams and the composite beams are calculated and checked against the analysis results (demand) in VisualAnalysis.

#### Pre-Composite (Construction) Beam Capacity

The non-composite steel beam flexural strength is determined according to Chapter F of the AISC 360 Specification for Structural Steel Buildings. The lateral-torsional buckling modification factor,  $C_b$ , is determined automatically from the analysis results. The unbraced length,  $L_u$ , is determined from the user specified parameters defined in the Bracing (Pre-Composite) section of the [Project Manager | Modify](#) tab.

#### Composite Beam Capacity

The composite steel beam positive flexural strength (i.e. the concrete is subject to flexural compression) is determined according to Chapter I of the AISC 360 Specification for Structural Steel Buildings and Part 3 of the AISC Steel Construction Manual. The positive flexural strength is determined from the plastic stress distribution on the composite section for the limit state of yielding (plastic moment) as shown in the image below. The composite capacity of the beam depends on the location of the Plastic Neutral Axis (PNA). The shear force between the steel beam and the concrete slab transferred by the steel anchors is the lowest value based on the limit states of concrete crushing, tensile yielding of the steel section, or the shear strength of the steel anchors.

**Plastic Stress Distribution**

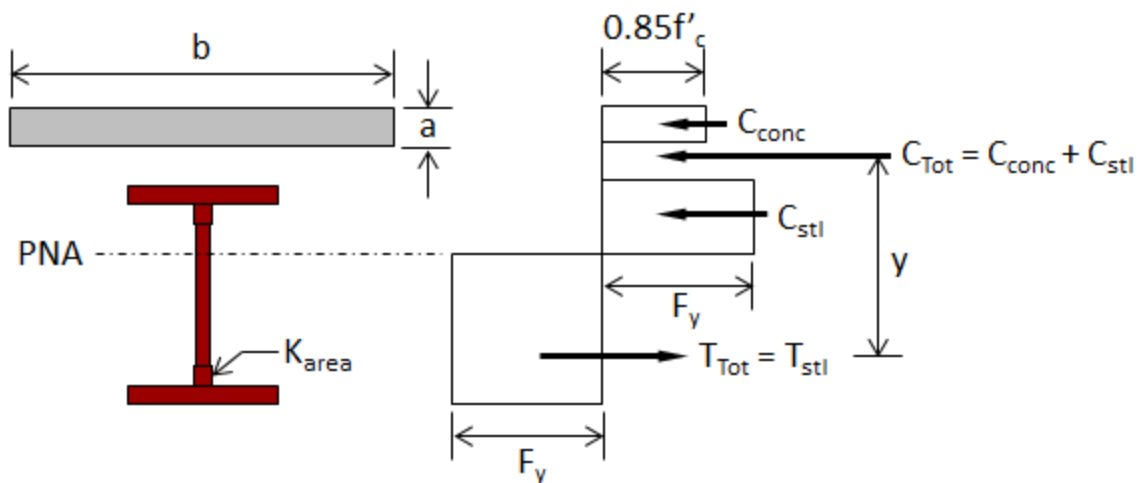

The composite beam capacity is determined at each offset along the member that falls in a positive moment region. The minimum number of steel anchors from the offset location to the point of zero moment in either direction (denoted as "effective studs" in the design output) is used when calculating the positive flexural strength for the composite beam as shown in the image below. The negative flexural strength (i.e. the concrete is subject to flexural tension) is calculated according to Chapter F of the AISC 360 Specification for Structural Steel Buildings assuming that the unbraced length is equal to the member length and the lateral-torsional buckling modification factor,  $C_b$ , is equal to 1.0.

**Number of Anchors for  $\Sigma Q_n$**

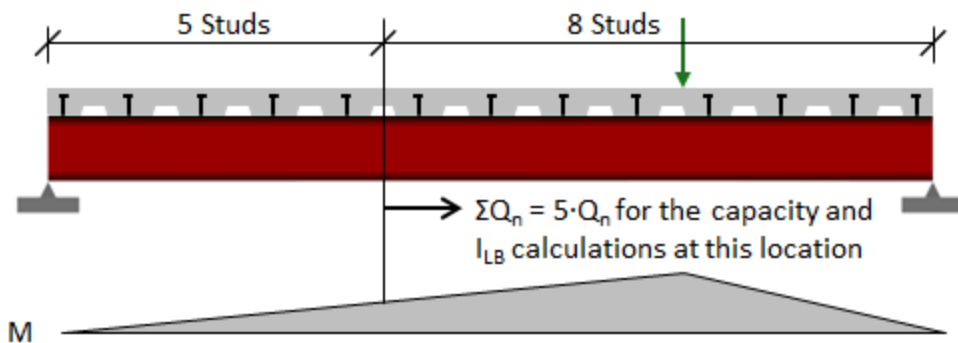
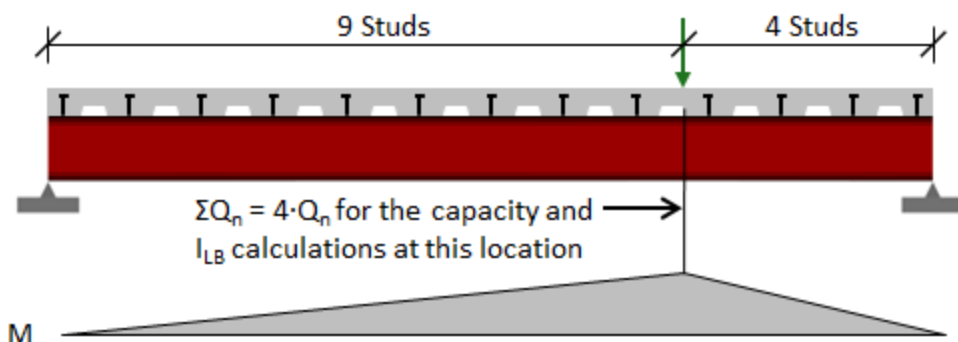

## Controlling Strength Unity Value

The composite beam capacity is determined at each offset along the member and compared with the demand at the corresponding offset. Since the demand and capacity vary along the length of the beam, the controlling unity value (largest demand/capacity ratio) may not occur at the point of maximum moment. The image below shows the demand vs. capacity moment diagrams for a simply supported composite beam with uniform load and a single stud region. For this case,  $Unity_2$  at offset  $x_2$  (the center of the member) is less than  $Unity_1$  at offset  $x_1$  (a location away from the center of the member). Therefore,  $Unity_1$  controls for this member. VisualAnalysis allows the spacing of steel anchors to be defined in multiple regions of the beam so that capacity of the member can be tailored to the beam's demand.

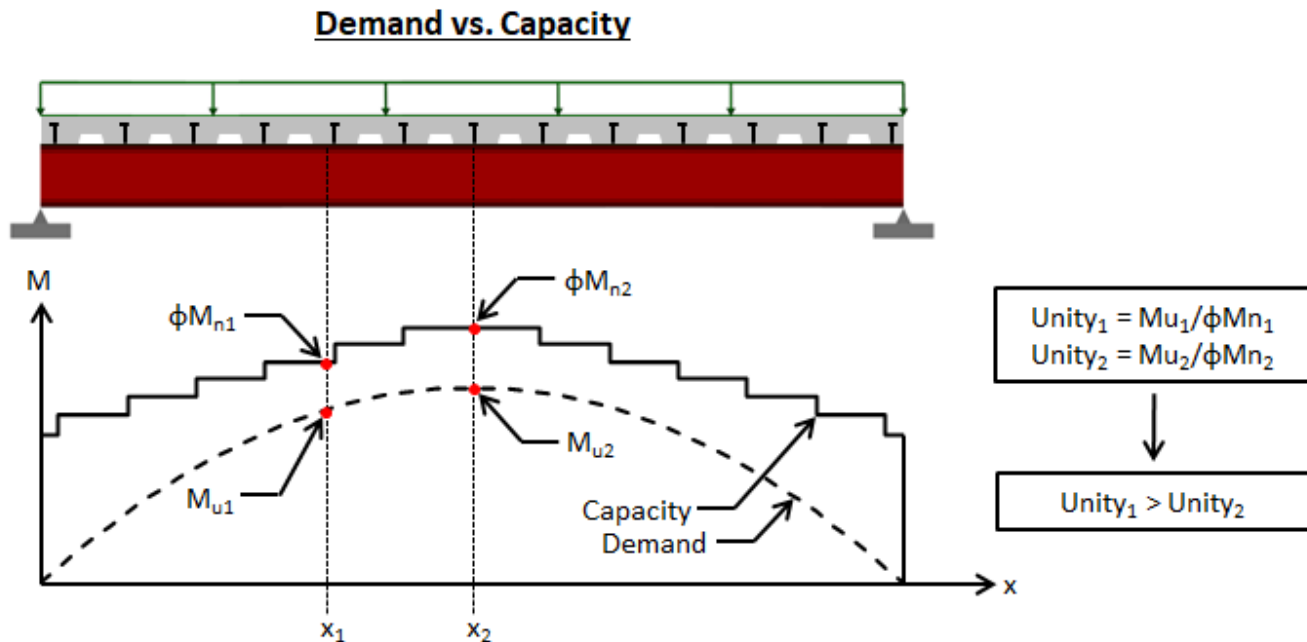

## Beam Deflections

VisualAnalysis can determine both the pre-composite and composite deflections of a beam. The permanent pre-composite deflections are automatically added to the beam's composite deflections to produce the total deflection. Both the pre-composite deflections and the total deflections are compared with the user defined deflection limits.

### Pre-Composite (Construction) Beam Deflections

- **Shored Construction Type** - The beam is assumed to be continuously shored resulting in no permanent pre-composite deflections.
- **Unshored (Approximate) Construction Type** - The permanent pre-composite deflections are automatically calculated based on the self-weight of the beam, the weight of the concrete deck, and the specified deck weight. Also, the beam is assumed to be simply supported and the non-composite steel beam's moment of inertia is used in the calculation.
- **Unshored (Defined Loads)** - The pre-composite deflections are calculated using the Construction Deflection Load Combinations. The permanent pre-composite deflections are calculated using the Construction Deflection Load Combinations that only have loads from a Dead Load source. The non-composite steel beam's moment of inertia is used in the calculation.

### Composite Beam Deflections

VisualAnalysis uses the lower bound moment of inertia as described in the AISC Steel Construction Manual in calculating the composite beam deflections. The lower bound moment of inertia of the beam depends on the location of the Plastic Neutral Axis (PNA). The minimum number of steel anchors from the offset location to the point of zero moment in either direction (denoted as "effective studs" in the design output) is used when calculating the lower bound moment of inertia for the composite beam as shown in the image above. The composite deflections are determined by scaling the deflection results of the non-Construction Deflection Load Combinations by the ratio of the steel moment of inertia to the lower bound moment of inertia. For the Unshored (Approximate) Construction type, the permanent pre-composite deflections are subtracted prior to scaling since the applied dead loads are assumed to include the total dead load on the system. The composite beam deflections are determined at each offset along the member with the lower bound moment of inertia calculated at for the corresponding offset. The lower bound moment of inertia,  $I_{LB}$ , is defined as follows (note: for negative moment regions  $I_{LB} = I_s$ ):

$$I_{LB} = I_s + A_s(Y_{ENA} - d_3)^2 + (\Sigma Q_n/F_y)(2d_3 + d_1 - Y_{ENA})^2$$

where

$A_s$  = area of steel cross section

$d_1$  = distance from the compression force in the concrete to the top of the steel section

$d_3$  = distance from the resultant steel tensions force from full section tension yield to the top of the steel

$I_{LB}$  = lower bound moment of inertia

$I_s$  = moment of inertia for the structural steel section

$\Sigma Q_n$  = sum of the nominal strengths of steel anchors between the point of maximum positive moment and the point of zero moment to either side

$$Y_{ENA} = [A_s d_3 + (\Sigma Q_n/F_y)(2d_3 + d_1)]/[A_s + (\Sigma Q_n/F_y)]$$

## Total Beam Deflections

The total deflections are the summation of the permanent pre-composite deflections and the composite deflections. For shored construction, the pre-composite deflections are zero, causing the total deflections to equal the composite deflections. The following image shows the pre-composite deflections, composite deflections, and total deflections for both the shored and unshored construction conditions.

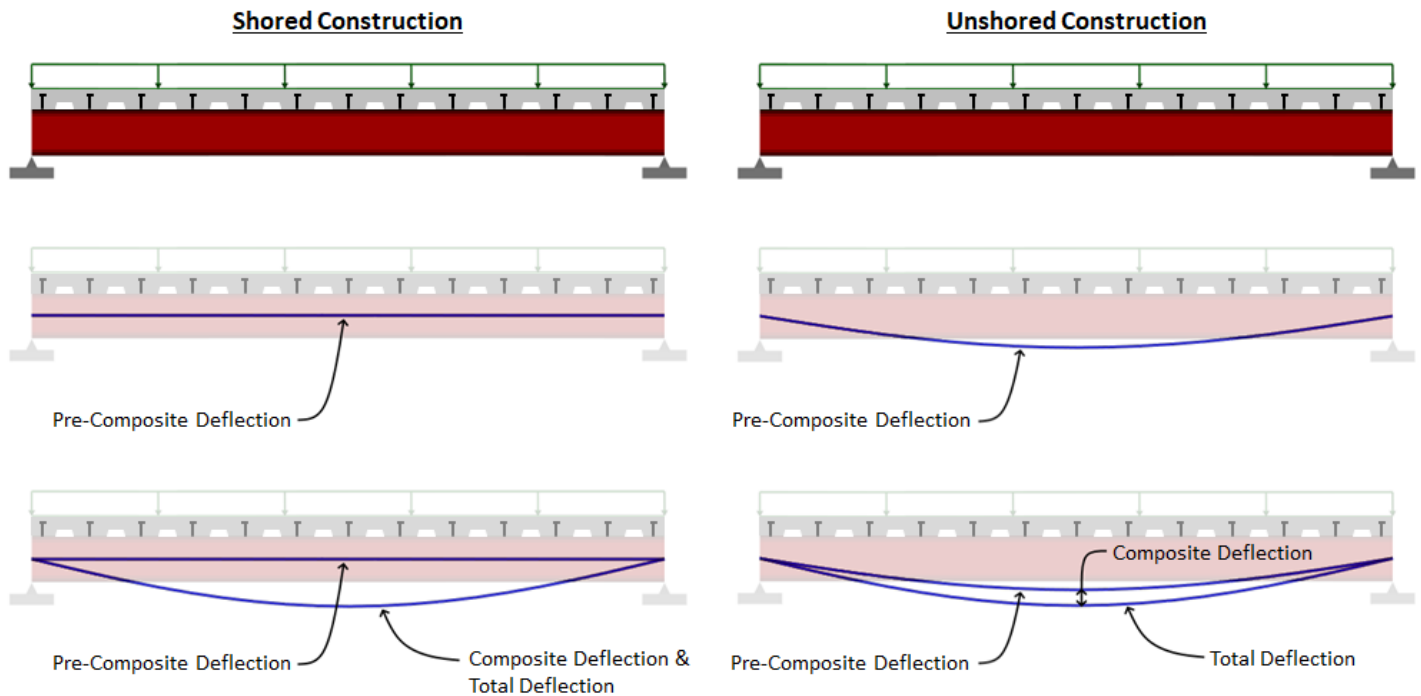

## Controlling Deflection Value

VisualAnalysis calculates the composite beam's lower bound moment of inertia at each offset along the member and calculates the corresponding deflection to compare with the deflection limit. Since the lower bound moment of inertia varies along the beam's length, the controlling (largest) deflection may not occur at the point of maximum moment or at the center of the beam. The image below shows the lower bound moment of inertia for a simply supported composite beam with uniform load and a single stud region. For this case, it is possible for VisualAnalysis to calculate  $\Delta_2$  at offset  $x_2$  (the center of the member) to slightly less than  $\Delta_1$  at offset  $x_1$  (a location away from the center of the member).

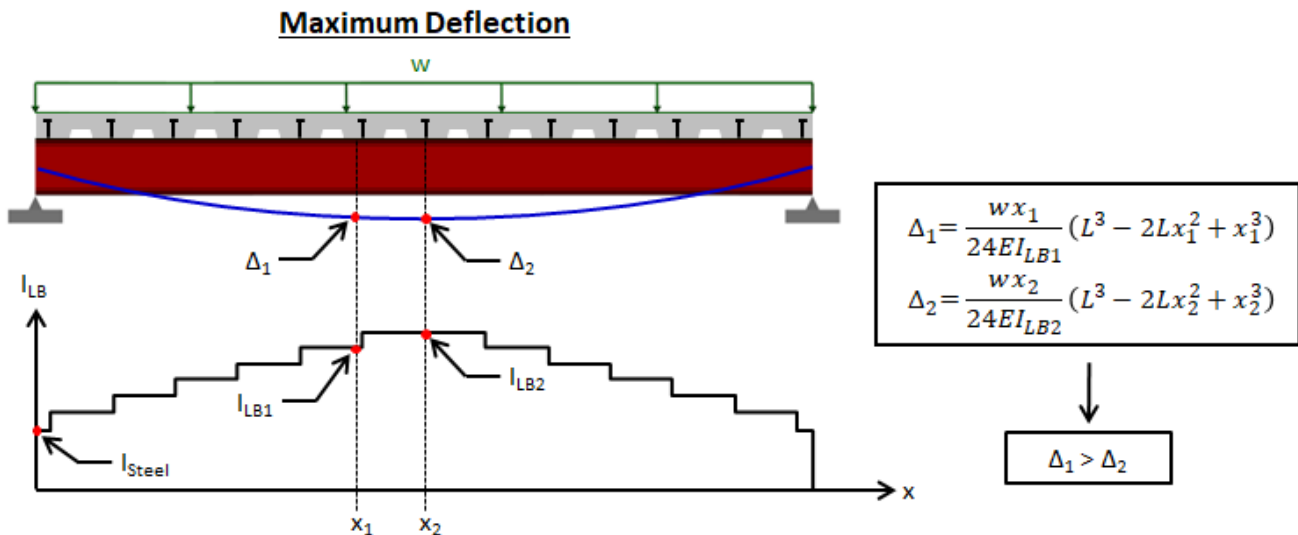

## Detailing Requirements & Limitations

In addition to checking the capacity and deflection limits for composite steel beams, VisualAnalysis checks to ensure that

the detailing requirements and limitations specified in Chapter I of the AISC 360 Specification for Structural Steel Buildings are met, including: material limitations, rib limitations, stud diameter limitations, stud length limitations, slab thickness limitations, and detailing requirements. Note: The steel anchor ductility checks discussed in the Chapter I Commentary of the AISC 360 Specification are not performed and should be completed by the engineer outside of VisualAnalysis.

## Composite Steel Member Design Process

To achieve an adequate design, the section for the members in a Design Group can be manually adjusted along with the concrete slab, deck, and anchor parameters until all the design checks pass. Note: The built in optimization feature in VisualAnalysis can be used to find an adequate steel shape for the composite beam members in a Design Group, however the concrete slab, deck, and anchor parameters must be adjusted manually as these parameters cannot be automatically optimized.

### 1. Create the Members

In the Model View draw or create the steel members.

### 2. Support the Members

Define support conditions for the model and apply the service level loads to the members.

### 3. Load the Members

Prior to loading the members, it should be decided which construction type is to be used for the beam-slab system. As explained above, the Construction Type is used to define the pre-composite demands (strength and deflection) for the beam-slab system. The Construction Type governs how the loads should be applied to the members and how the Load Combinations should be defined in the Load Case Manager. The following guidelines should be used for applying loads and creating load combinations for the three construction types.

- **Shored Construction** - Apply the loads (Dead, Live, etc.) that the beam-slab system will experience after the concrete deck has cured, the shoring is removed, and the beam and slab act as a composite or partial-composite system (i.e. the non-construction loads). The dead load should include the self-weight of the beam, the weight of the concrete slab, the weight of any permanent deck forms in addition to any other dead loads on the system. Set the desired Strength and Deflection load combinations in the Load Case Manager for the composite or partial-composite system. Construction Load Combinations are not needed for the Shored Construction Type.
- **Unshored (Approximate) Construction** - Apply the loads (Dead, Live, etc.) that the beam-slab system will experience after the concrete deck has cured and the beam and slab act as a composite or partial-composite system (i.e. the non-construction loads). The non-construction dead load should include the self-weight of the beam, the weight of the concrete slab, the weight of any permanent deck forms in addition to any other dead loads on the system. Set the desired Strength and Deflection load combinations in the Load Case Manager for the composite or partial-composite system. Construction Load Combinations are not needed for the Unshored (Approximate) Construction Type as VisualAnalysis automatically checks the capacity and deflection limits of the non-composite unshored beam for the pre-composite construction condition. Furthermore, VisualAnalysis automatically accounts for the permanent pre-composite deflection in the composite deflection checks.
- **Unshored (Defined Loads) Construction** -
  1. Create Service Cases for the pre-composite construction load (e.g.  $D_{const}$ ,  $L_{const}$ ) and for the Camber (if needed). The  $D_{const}$  and Camber Service Case should have a Dead Load Source.
  2. Apply the construction loads (e.g.  $D_{const}$ ,  $L_{const}$ ), non-construction loads (e.g. D, L), and camber load (Camber) to the beam in the appropriate Service Cases. Note: The non-construction dead load (D) is not the total dead load (i.e. it should not include any construction dead load) and the camber load should be applied in the opposite direction of the dead construction load (i.e. the magnitude should be set to cause the beam to deflect the appropriate amount).
  3. Create the construction (e.g.  $1.2D_{const} + 1.6L_{const}$ ) Strength Load Combinations specifying 'Yes' for the Load Combination's Construction parameter.

4. Create the non-construction (e.g.  $1.2D_{\text{const}} + 1.2D + 1.6L$ ) Strength Load Combinations.
5. Create the construction (e.g.  $D_{\text{const}} + \text{Camber}$ ,  $L_{\text{const}}, D_{\text{const}} + \text{Camber} + L_{\text{const}}$ ) Deflection Load Combinations specifying 'Yes' for the Load Combination's Construction parameter. Note: The permanent pre-composite deflections are calculated using the Construction Deflection Load Combinations that only have loads from a Dead Load source (e.g.  $D_{\text{const}} + \text{Camber}$ ) and are accounted for in the non-construction (composite) beam deflection limits.
6. Create the non-construction (e.g.  $D$ ,  $L$ ,  $D + L$ ) Deflection Load Combinations.

## 4. Specify the Parameters

Select a preliminary steel Database Shape or Standard Parametric Shape and set the material properties for the beam.

## 5. Analysis and Preliminary Design

VisualAnalysis will automatically analyze the model and perform the appropriate design checks. Simply click on the Results View tab to view the analysis results for the model. The deflections shown in the analysis results are based on the moment of inertia of the steel beam. These results are scaled as described in the Deflections section above to account for the composite or partial composite action of the beam-slab system prior to being used for the deflection checks. Simply click on the Design View tab to see the preliminary design results. The initial design results are for a non-composite beam as the composite beam parameter is set in the [Project Manager | Modify](#) tab when the Design View is activated.

## 6. Create/Modify Design Groups

VisualAnalysis will automatically create groups for members based on material, orientation, length, and/or cross-section. Alternatively, Design Groups can be created or modified manually as explained in the [Groups Category](#).

## 7. Specify Steel Design Groups as Composite Beams

Set the Composite Beam parameter to 'Yes' for the Design Group in the Steel section of the [Project Manager | Modify](#) tab. When steel design group is marked as composite beam, sections for defining the concrete slab, deck, and studs appear in the [Project Manager | Modify](#) tab.

## 8. Specify the Construction Type

Set the Construction Type for the Design Group in the Concrete Slab section of the [Project Manager | Modify](#) tab. The specified Construction Type should correspond with how the members were loaded in Step 3.

## 9. Define the Parameters

For each Design Group, set the parameters in the Composite Beam, Bracing (Pre-Composite), Deflections, Concrete Slab, Deck and Anchors, etc. sections of the [Project Manager | Modify](#) tab in the Design View. The Bracing (Pre-Composite) section is not available for the Shored Construction Type. All of the Parameters in the [Project Manager | Modify](#) tab in the Design View must be adjusted manually as VisualAnalysis does not automatically optimize these parameters. When a parameter is modified, VisualAnalysis automatically recomputes the analysis results, the design checks, and updates the Unity Ratios for the members.

## 10. Design the Group

Select a Design Group and manually adjust the design parameters (concrete slab parameters, deck parameters, and anchor size and layout, etc.) in the [Project Manager | Design](#) tab in the Design View and/or adjust the member's shape in the [Project Manager | Modify](#) tab in the Model View until the Unity Ratios in the Design View are less than the Unity Success Limit defined in the Preferences. Note: The Design the Group button in the Design ribbon can be used to optimize the beam's shape as discussed in Steps 8-11 of the [Steel Member Design Process](#).

## Composite Steel Reports

The composite steel design reports in VisualAnalysis are highly customizable. To control what is included in a report, simply click on a table in the report and adjust the settings in the [Project Manager | Selected Table](#) tab. The Extreme Rows



feature is particularly useful to produce concise reports of only the controlling cases or to produce detailed reports that display every design check that is made. When this feature is set to Show All, the reports may become excessively large which can be controlled by adjusting the Conciseness feature. The reports for composite steel beam design include both a summary of the parameters input for the Design Group and tables that included the various design checks. These tables have the following columns:

Column Name	Description
Member	The member's name.
Section	The member's cross-section (e.g. W8x10).
Offset	This is the distance from the 'start' end of the member. The number and locations of offsets are as defined in the performance settings in VisualAnalysis.
Result Case	The result case that is used for the design check.
Demand/Capacity	These columns varies depending on the type of design check. In most cases these values are used directly in the unity check, but there are some special cases where the unity checks also include intermediate values or other values that not reported.
Code Reference	The controlling equations or provisions from the chosen design specification. For example, "G2-1" refers to the equation in the specification while a code reference like "I3.2a(a)" refers to a section in the design specification.
Unity Check	The unity check value for this particular member, load case, and offset. Unity checks are calculated as the absolute value of an actual force divided by an allowable strength [ASD] or as the ultimate force (factored) divided by the design strength (factored) [LRFD].
Details	Intermediate values and other information which can be helpful for validating results.

## Assumptions and Limitations

- **Shapes** - Composite steel beam design is only available for I-shapes, channels, and square or rectangular tubes.
- **Specifications** - At this time, only the AISC design specifications are supported for composite beam design.
- **Anchor Ductility** - The steel anchor ductility checks discussed in the Chapter I Commentary of the AISC 360 Specification are not performed and should be completed by the engineer outside of VisualAnalysis.
- **Negative Flexural Strength** - When the concrete is subject to flexural tension, the negative flexural capacity is calculated assuming that the unbraced length is equal to the member length and the lateral-torsional buckling modification factor,  $C_b$ , is equal to 1.0.

## Steel References

1. American Institute of Steel Construction (AISC), Specification for Structural Steel Buildings, ANSI/AISC 360-16. 2016 Edition.
2. American Institute of Steel Construction (AISC), Specification for Structural Steel Buildings, ANSI/AISC 360-10. 2010 Edition.
3. American Institute of Steel Construction (AISC), Specification for Structural Steel Buildings, ANSI/AISC 360-05. 2005 Edition.

## 5.10 Concrete Design

**Requires: Full Design Level**

## Introduction

VisualAnalysis designs concrete structures according to the following design specifications:

- ACI 318-14
- CSA A23.3-14
- ACI 350-06 (plates only)

To simplify the design process, members with similar parameters are placed in Design Groups while plates with similar parameters are placed in Design Meshes. VisualAnalysis performs Unity Checks for each element in the Group or Mesh based on the analysis results, the element's parameters (shape, dimensions, reinforcement, etc.), the element type (beam, column, or slab), and the chosen design specification. To achieve an adequate design, the parameters of the elements in the model can be manually adjusted until all the design checks pass. Alternatively, the built in optimization features in VisualAnalysis can be used to iterate through element parameters and find an adequate solution. The design process for beams, columns, and slabs are described in their respective sections.

## Concrete Design Types

- [Concrete Beam Design](#)
- [Concrete Column Design](#)
- [Concrete Wall/Slab Design](#)

## Concrete Design References

1. American Concrete Institute, ACI 318-14, Building Code Requirements for Reinforced Concrete.
2. American Concrete Institute, ACI 350-06, Code Requirements for Environmental Engineering Concrete Structures and Commentary.
3. Canadian Standards Association, CSA A23.3-14, Design of Concrete Structures.

## 5.11 Concrete Beam Design

**Requires: Full Design Level**

### Introduction

VisualAnalysis performs concrete beam design according to the following design specifications:

- ACI 318-14
- CSA A23.3-14

Beams are designed by checking the flexure, shear, and torsion capacity of the cross-section with the varying demands at numerous locations along the length of the member. The maximum unity value (demand to capacity ratio) for the member is shown in both the Design View and in the Report View, allowing the user to quickly identify if the member is passing ( $\text{unity} \leq \text{Unity Success Limit}$ ) or failing ( $\text{unity} > \text{Unity Success Limit}$ ). In addition to checking the beam's capacity, VisualAnalysis checks the minimum and maximum reinforcing limits and the reinforcement spacing requirements according to the provisions of the selected design specification. The parameters for beams can be manually adjusted in the [Project Manager | Modify](#) tab until a satisfactory design is reached or VisualAnalysis can automatically optimize certain parameters of the Design Group using the Design the Group button in the Design Ribbon. Design checks are only performed for load combinations that fall under the Strength (LRFD) Design Category (see [Load Case Manager](#)).

## Concrete Beam Section Definition

VisualAnalysis can design beams that have the following cross-sections:

1. Rectangular (isolated beam),
2. Spandrel (slab extension to one side only)
3. Tee (slab extension to both sides)

These three parametric shapes are defined in terms of depth, width, flange thickness, and web thickness, as shown in the figure below.

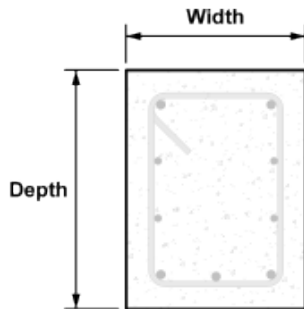

Rectangle (Depth > Width)

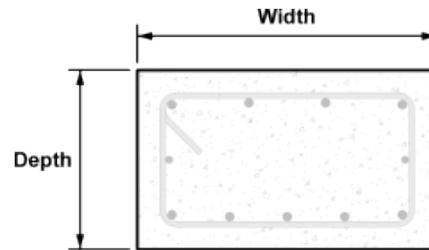

Rectangle (Depth < Width)

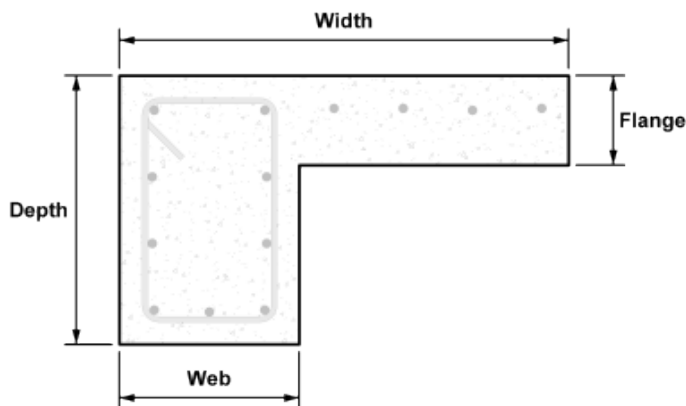

Spandrel

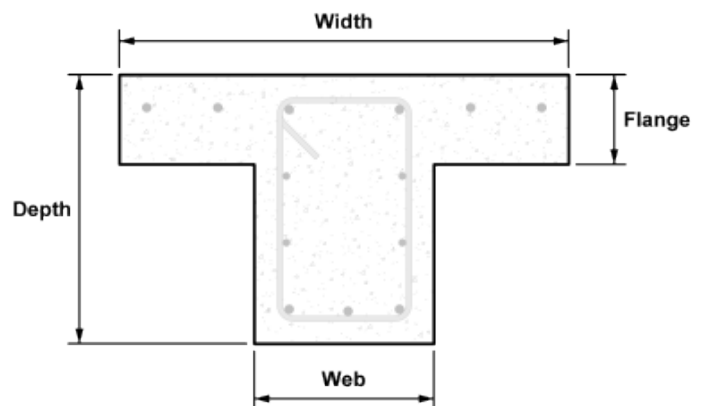

Tee

## Geometric Coordinate System

The beam's longitudinal reinforcement, is defined in the section's Geometric Coordinate System. The figure below defines the top, bottom, and side reinforcement with respect to the  $y_{geo}$ -axis and the  $x_{geo}$ -axis for the three concrete shapes available for design (the top bars are always in the positive  $y_{geo}$ -direction while the bottom bars are always in the negative  $y_{geo}$ -direction).

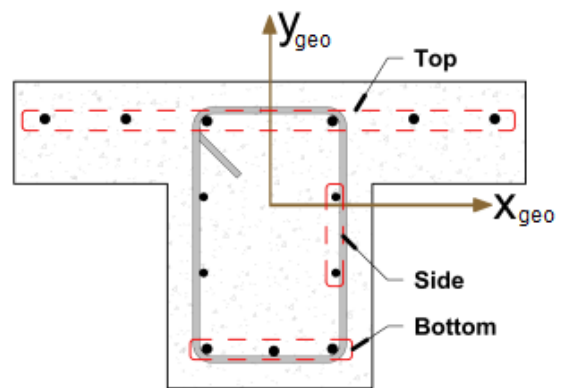
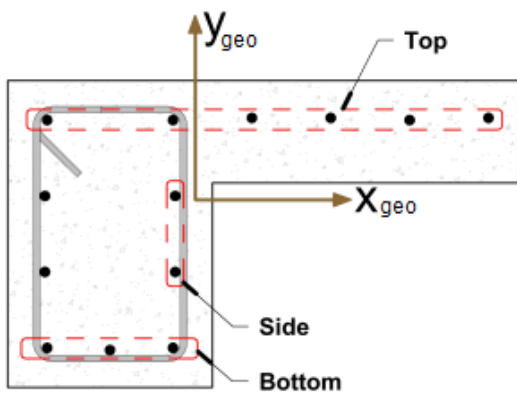
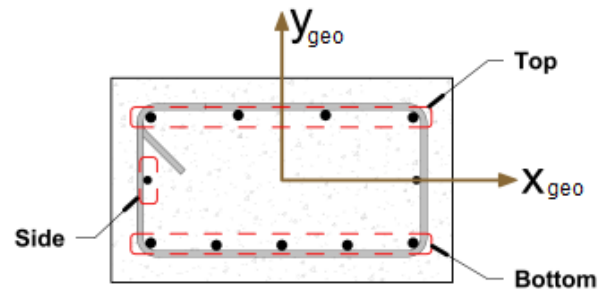
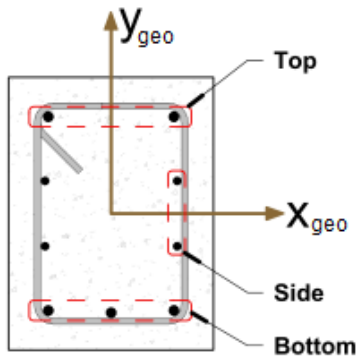

## Member's Geometric vs. Local Coordinate Systems

Members in VisualAnalysis are modeled such that the  $z_{local}$  and  $y_{local}$  axis align with the shape's major and minor principal axis, respectively. Therefore, the member's [Local Coordinate System](#) does not align with the shape's Geometric Coordinate System as illustrated below. The principle angle (alpha) is defined as the angle between the cross-section's geometric x-axis ( $x_{geo}$ ) and the major principal axis ( $z_{local}$ ) where a counter-clockwise rotation is positive. The figure below shows the principle angles for the various concrete beam cross-sections. Using the principle angle and member's local axis orientation, it can be determined which edge of the beam is the top and which edge is the bottom. If the beam is not oriented correctly (i.e. if the top bars do not coincide with the "top" of the building), simply adjust the Beta angle for the member. Creating a couple of simple test cases and reviewing the Unity Ratios for a given loading condition can also help determine how the reinforcement is distributed.

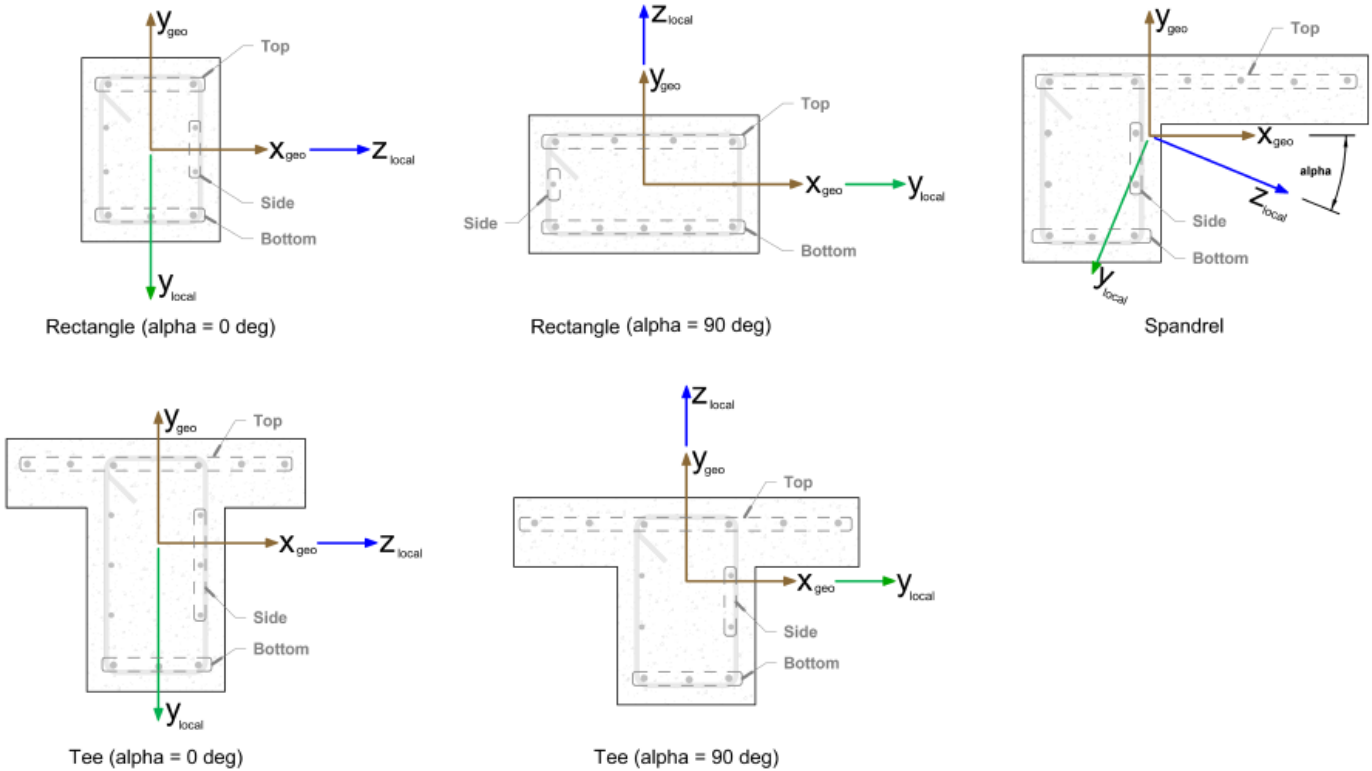

**Reinforcement Regions**

Since the demands typically vary along the length of a beam, VisualAnalysis divides beams into three segments and allows both the longitudinal and transverse reinforcement to vary in each segment as shown in the figure below. The longitudinal bars are assumed to be fully developed at the start and end of each segment. Depending on the spacing constraints of the design specification, the top and bottom longitudinal bars will be placed in either one or two layers and the distance from the extreme compression fiber to the centroid of the longitudinal reinforcement will be adjusted in the calculations accordingly.

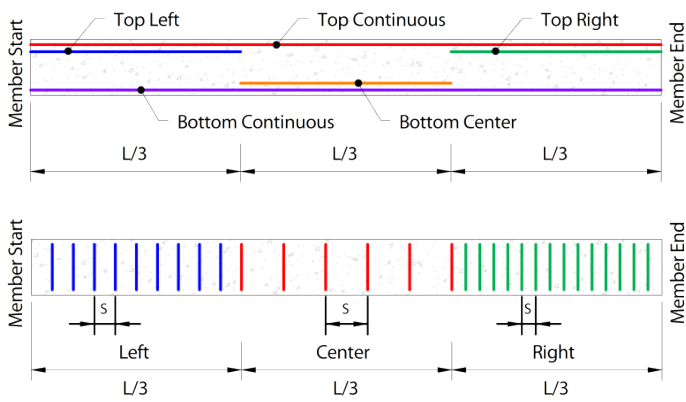

**Bending Design**

VisualAnalysis uses strain compatibility, equilibrium, the elastic-perfectly plastic constitutive law for steel, and the Whitney rectangular stress distribution for concrete to determine the flexural capacity of beams. In determining the flexural capacity of a beam, the ACI and CSA design specifications use slightly different values for the maximum concrete compression

# VisualAnalysis 19 User's Guide

strain, the ratio of average stress in the rectangular compression block to the specified concrete strength ( $\alpha_1$ ), the ratio of depth of rectangular compression block to depth to the neutral axis ( $\beta_1$ ), and the strength reduction factor ( $\phi$ ). The following table shows the values for these limits or provides the applicable code reference.

	Strain Limit	$\alpha_1$	$\beta_1$	$\phi$
ACI	0.0030	0.85	(22.2.2.4.3)	(21.2.1)
CSA	0.0035	(10.1.7)	(10.1.7)	$\phi_c = 0.65$ $\phi_s = 0.85$

## Shear and Torsion Design

VisualAnalysis designs beams for one-way shear where the effects of axial load on the beams are not considered. VisualAnalysis ensures that the minimum transverse steel area and spacing requirements are met, along with the limits of the cross-section for torsion. Furthermore, VisualAnalysis checks the shear and torsion capacity of beams at numerous locations along the beam and reports the maximum unity value (defined as the demand divided by the capacity) for the member. When the number of legs of transverse bars exceeds two (as shown in the figure below), VisualAnalysis assumes that only the two outer legs of the transverse reinforcement resist torsion while all legs of the transverse reinforcement equally resist shear.

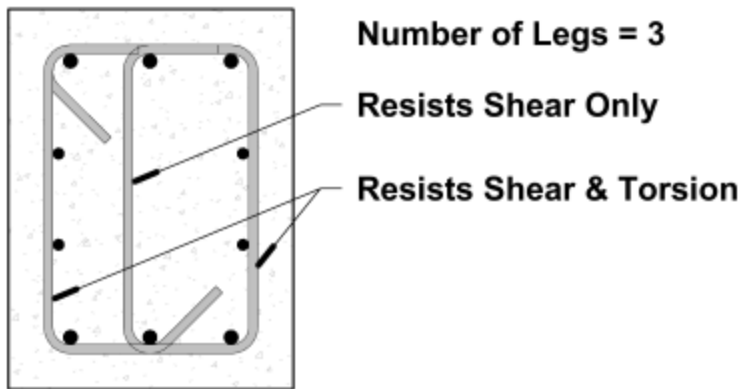

### CSA A23.3

The  $\beta$  and  $\theta$  parameters for shear and torsion design are determined using the General Method outlined in the CSA specification. In this method, the longitudinal strain at mid-depth of the cross-section,  $\epsilon_x$ , is computed accounting for the influence of flexure, shear, and torsion. When the cross-section contains at least the minimum transverse reinforcement, the equivalent crack spacing parameter,  $s_{ze}$ , is taken as 300 mm. Otherwise,  $s_{ze}$  is calculated with  $s_z = d_v$  and  $a_g = 0$ , conservatively. The side bars on flexural tension side of the cross-section are accounted for in the calculation of the effective shear depth,  $d_v$ . Since  $\beta$  and  $\theta$  are a function of the factored design moment, shear, and torsion which tend to vary along the length of the beam, the shear and torsion capacity can also vary along the beam's length even when the reinforcement remains constant. Therefore, the unity value is checked at numerous locations along the length of the member and the maximum value is reported. In addition to checking the capacity of the beam, VisualAnalysis checks the various detailing requirements in the CSA specification including the proportioning of the longitudinal reinforcement on the tension side and the compression side.

## Concrete Beam Parameters

Several parameters must be defined to design a concrete beam in VisualAnalysis. The design parameters are set in the [Project Manager | Modify](#) tab when the Design View is selected. After creating a Design Group, choose one of the members that belongs to the group in the Design View to set up the Design Group's Parameters. Since the design parameters apply to all members in the Design Group, it is often best to choose the most conservative condition that applies to any member in the group.

## Concrete

**Specification** - The Design Specification used to design the members in the Design Group.

### High Seismic? - (ACI Only, Use Reduced $\phi$ Factors for Members Resisting Earthquake Effects)

Enabling this parameter lowers the  $\phi$  factors as indicated by ACI 318 Section 21.2.4 for members that are designed to resist earthquake effects and are part of a structure that relies on special moment resisting frames or special structural walls to resist earthquake effects. VisualAnalysis relies solely on this parameter in determining whether or not to use reduced  $\phi$  factors (it does not attempt to calculate whether the shear capacity is greater than the shear corresponding to the development of the nominal flexural strength of the member). Only shear  $\phi$  factors are influenced by this parameter for design according to the ACI specification.

**Member Type** - Indicates the design shape (Beam or Column).

**Overstrength?** - Causes the Design Group to be designed using overstrength load combinations.

**Live Load Reduction** - If specified, design checks will only consider result cases with the matching live load reduction. Combinations with live load reduction can be created in the [Load Case Manger](#).

**Disable Checks?** - Causes selected design group to be omitted from design checks.

**Check Level** - Determines the level of detail reported from design checks. Options are: *To Failure* (Fastest), *Each Limit State*, and *All* (Slowest, but provides the most information).

## Beam Details

**Beam Spacing** - The perpendicular spacing between beams (centerline-to-centerline). This is used for Spandrel and Tees to determine the effective flange width and is not necessary for beams with rectangular cross sections. The effective flange width used for design is the minimum of the code calculated value for effective width and the actual width of the parametric tee or spandrel shape.

**Start/End Column Widths** - Widths of supporting columns at start and end of beam. These widths are used for determining where critical moment, shear, and torsion are at the ends of the beam. The critical demands are taken at the face of the column since member's effective depth significantly increases once the column is reached. These ends correspond to the [member's local axes](#), where the local x-axis goes from the start-node to the end-node. Note that the critical section for shear can be taken "@ d" from the face of the support using the "Shear "@ d" from start/end" parameter (below).

**Shear "@ d" from start/end** - When enabled, the shear value calculated "@ d from the face" of the support is used for the shear and torsion checks when the check location is between the face of the support and d. Note that when using the CSA design specification, "dv" is used instead of "d".

**Use Metric Bars** - Should metric reinforcement be used instead of imperial bar sizes?

## Reinforcement

**Main  $F_y$**  - Specified yield strength of the longitudinal reinforcement in the beam.

**Top Reinforcement** - The size and quantity of Top reinforcement throughout the beam.

**Bottom Reinforcement** - The size and quantity of Bottom reinforcement throughout the beam.

**Side Reinforcement** - The size and quantity of Side reinforcement throughout the beam per each side. Note side bars are not used to resist flexure.

**Stirrup  $F_y$**  - Specified yield strength of the stirrups in the beam.

**Stirrup Size** - The size of transverse reinforcement.

**Number of Legs** - The number of legs used for shear reinforcement.

**Are Stirrups Closed?** - Are closed stirrups used throughout the section?

**Spacing** - The center-to-center spacing of the stirrups. A different stirrup spacing can be specified for each 1/3 of the beam length. A spacing of 0 means no stirrups are provided.

**Top Cover** - Concrete clear cover at the top of the section. Calculated as the distance from the top of the stirrup to the top of the section.

**Bottom Cover** - Concrete clear cover at the bottom of the section. Calculated as the distance from the bottom of the stirrup to the bottom of the section.

**Side Cover** - Concrete clear cover at the side of the section. Calculated as the distance from the side of the section (or web in the case of Tee and Spandrel shapes) to the stirrup.

**Deflections**      **Strong/Weak** - Specifies the type of limit for normal beam deflections.

**Size Constraints**      **Limit Depth/Width?** Allows the design search to 'Fail' if the shape is outside of the Min/Max range.

## Concrete Beam Design Process

To achieve an adequate design, the Design Group's Parameters can be manually adjusted until all the design checks pass. Alternatively, the built in optimization feature in VisualAnalysis can be used to iterate through some of the beam parameters to find an adequate solution using the following process:

### 1. Create the Beams

In the Model View draw or create the concrete beam members.

### 2. Support and Load the Beams

Define support conditions for the model and apply the service level loads to the members. Set the strength design load combinations in the Load Case Manager.

### 3. Specify Preliminary Parameters

Set the preliminary beam shapes, dimensions, and material properties. Note that concrete beams must have Standard Parametric cross-sections and all concrete beams in a Design Group must have the same shape and dimensions.

### 4. Analysis and Preliminary Design

VisualAnalysis will automatically analyze the model and perform the appropriate design checks. Simply click on the Results View tab to view the analysis results for the model or the Design View tab to see the design results. VisualAnalysis uses default parameters for concrete beam reinforcement that will likely need to be adjusted (see Step 7).

### 5. Create/Modify Design Groups

VisualAnalysis will automatically create groups for members based on material, orientation, length, and/or cross-section. Alternatively, Design Groups can be created or modified manually as explained in the [Groups Category](#).

### 6. Concrete Parameters

For each Design Group, select the appropriate design specification, member type, seismic & overstrength parameters, etc. in the [Project Manager | Modify](#) tab in the Design View.

### 7. Define Reinforcement

Manually adjust the reinforcement in the [Project Manager | Modify](#) tab in the Design View. The layout, size, quantity, and yield strength of the longitudinal bars can be set while the size, spacing, and yield stress of the member's transverse bars can be set. Upon changing the reinforcement for a Design Group, the unity checks are automatically updated in the Design



View.

## 8. Design the Group

After selecting a concrete beam design group, click the Design the Group button in the Design ribbon. In the Design Selection dialog box, choose a parametric type and set the constraints on the dimensions for the cross-section of the concrete member. Click the Optimize Now button to search for various sections and display the unit value for each section using the reinforcement that was defined in the previous step. Note that VisualAnalysis does not vary the reinforcement for each section and only optimized the size of the parametric shape. If a warning stating "demands could not be satisfied" appears, then all the sections within the search parameters have a unity value larger than the Unity Success Limit defined in the Preferences. Enabling the Return all Shapes feature will provide information on every considered section which may be useful for determining why a section failed or was not optimal.

## 9. Select a Section

Once the optimization is complete, select a section from the list and click the Accept Design button. Now the unity value for all members in the design group are displayed using the selected section. The tilde symbol (~) in front of the unity value indicates that the unity checks must be validated with another analysis since the member stiffness and resulting load distribution may have changed.

## 10. Synchronize Design Changes

Click the Synchronize Design button in the Design ribbon to automatically update the model with the new cross-section, re-analysis the model with the new member stiffness, and rerun the design checks with the updated analysis results.

## 11. Verify Unity Ratios

The final step in the design process is to verify that Unity Ratios in the Design View are less than the Unity Success Limit defined in the Preferences. If member sizes were drastically changed during the design process, final unity ratios can differ from predicted unity ratios because the analysis results may vary significantly.

## Concrete Beam Reports

Design reports are available by double-clicking on a member in the Design View, by selecting a member and clicking the Report Selected button in the **right-click** context menu, or by adding tables individually from the Report View. The Concrete Beam Parameters used for the Design Group are available with the Member Design Results table by clicking in the table and enabling the Include Parameters setting in the **Project Manager | Select Table** tab.

## Concrete Beam Assumptions and Limitations

- Axial forces and/or biaxial bending is not considered. Design the member as a column for these types of loading conditions.
- Left/Right sides of beam correspond to the [member local axes](#). Thus, the 'start node' corresponds with the left third and the 'end node' corresponds with the right third.
- Longitudinal reinforcement is calculated for each 1/3 span. Rebar is assumed to be terminated at the 1/3rd points of the beam (i.e. cutoff locations are not determined) and rebar development lengths are not considered.
- The demands for flexure, shear, and torsion near a support are taken at the face of the support since the member's effective depth significantly increases once the support is reached. With an exception for shear, being that the critical section can be taken "@ d" from the support by setting the "*Shear "@ d" from start/end*" parameter to Yes.
- Splitting members is not recommended. Care should taken when trying to design members that have been split into multiple member elements. The reinforcement details assume that the endpoints of the members are at supports. Therefore, a beam spanning supports may cause inaccurate results.
- While the longitudinal bar location and stirrup arrangements cannot be displayed graphically, the specified reinforcement for each design group can be reported using Design Tables in the Report View.

- Concrete beams are assumed to have adequate bracing to prevent lateral-torsional buckling of the member (i.e. bracing is not a parameter for concrete design).
- Deep beams cannot be designed in VisualAnalysis and a warning will be provided if a beam has a clear-span length less than 4h. If a combined member is used to span across multiple supports, however, the program's check will not be accurate.

## 5.12 Concrete Column Design

**Requires: Full Design Level**

### Introduction

VisualAnalysis performs concrete column design according to the following design specifications:

- ACI 318-14
- CSA A23.3-14

Columns in VisualAnalysis can have one of four configurations:

1. Rectangular column with bars on two opposite faces
2. Rectangular column with bars on all four faces
3. Square column with a circular bar pattern
4. Circular column with a circular bar pattern

Columns with circular bar patterns can be designed using either ties or spirals for the confining reinforcement while columns with rectangular bar patterns must have ties. Concrete columns are designed for shear, axial tension without flexure, and combined axial compression and flexure to resist the varying demands along the length of the member. The maximum unity value (demand to capacity ratio) for the member is shown in both the Design View and in the Report View, allowing the user to quickly identify if the member is passing ( $unity \leq Unity\ Success\ Limit$ ) or failing ( $unity > Unity\ Success\ Limit$ ). In addition to checking the column's capacity, VisualAnalysis checks the reinforcing limits and spacing requirements (for both the longitudinal and confining reinforcing) according to the provisions of the selected design specification. The parameters for columns can be manually adjusted in the **Project Manager | Modify** tab until a satisfactory design is reached or VisualAnalysis can automatically optimize certain parameters of the design group using the Design the Group button in the Design Ribbon. Design checks are only performed for load combinations that fall under the Strength (LRFD) Design Category (see [Load Case Manager](#)).

### Concrete Column Section Definition

The location and pattern of the reinforcement within a concrete column can significantly affect the capacity of the column. In VisualAnalysis, rectangular reinforcement patterns are modeled using discrete longitudinal reinforcement in the cross-section with the rebar evenly spaced along each face (see Figure 1). A minimum of 4 longitudinal bars are required for the rectangular pattern (acting as corner bars) while the number of intermediate bars on the y-face and z-face are specified by the user. Note that the member's local z-axis aligns with the cross-section's major principal axis (turning on the Picture View filter and the Member Local Axes filter makes it easy to determine the location of the reinforcement within the model). Circular reinforcement patterns are modeled using an equivalent "ring" of steel in the cross-section instead of modeling the bars at discrete points in the cross-section (see Figure 2). The radius to the center of ring equals the distance from the center of the column to the center of the longitudinal bars and the thickness of the ring is such that the ring's area equals the total area of the longitudinal bars. Modeling the circular reinforcement as a ring is beneficial as it does not require an assumption to be made for the location of the bars and produces identical interaction diagrams for bending about the z-axis and the y-axis. A minimum of 6 longitudinal bars are required for a circular reinforcement pattern. For both rectangular and circular longitudinal reinforcement patterns, only one bar size can be specified for all of the longitudinal reinforcement.

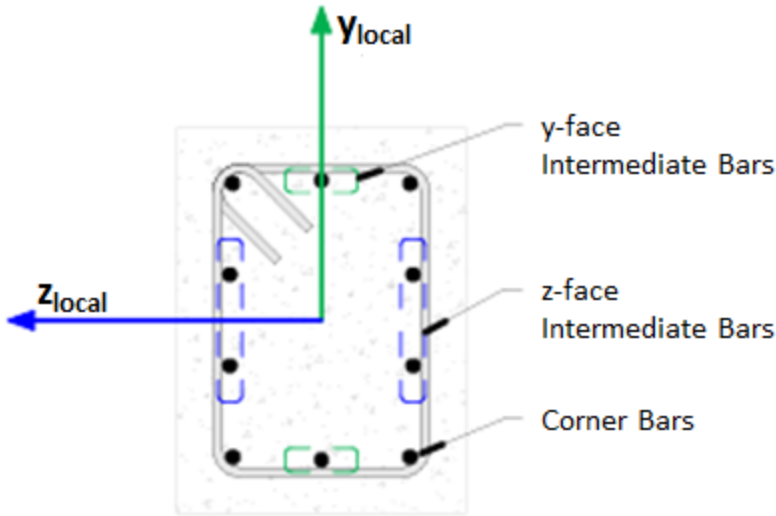

**Figure 1: Rectangular Longitudinal Reinforcement Layout**

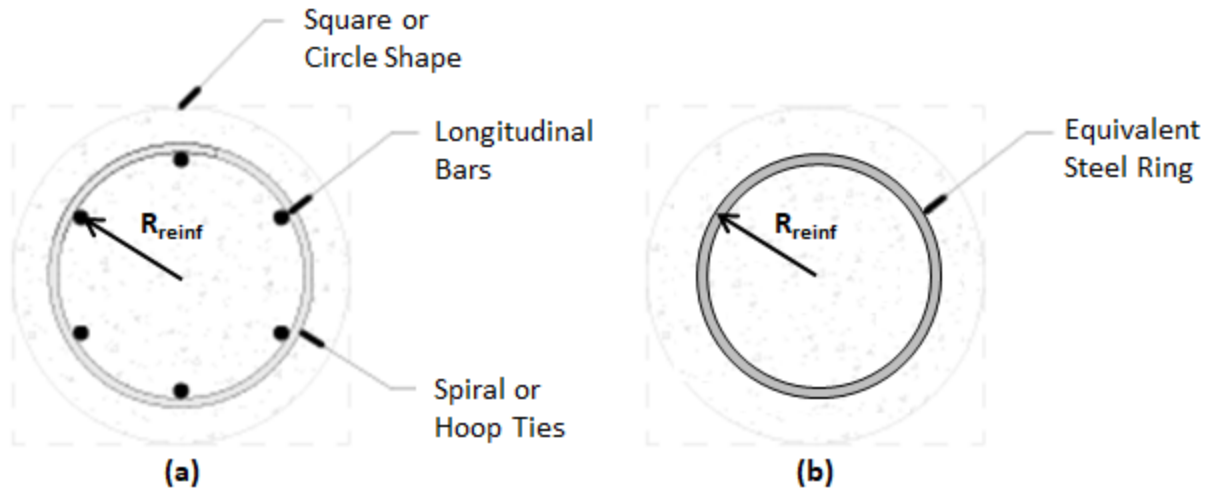

**Figure 2: (a) Circular Longitudinal Reinf. Layout (b) Modeled Reinf. Layout**

### Axial Compression & Uniaxial Bending (Interaction Diagrams)

VisualAnalysis develops both the Y-axis and Z-axis interaction diagrams for columns using strain compatibility, equilibrium, the elastic-perfectly plastic constitutive law for steel, and the Whitney rectangular stress distribution for concrete. The neutral axis depth is varied and the factored axial and flexural capacities are calculated. When the longitudinal reinforcement (discrete bars or any part of the steel ring) is located within the concrete compression block, the stress in the steel is reduced by the magnitude of the concrete compression block. In determining the capacity of a column, the ACI and CSA design specifications use slightly different values for the maximum concrete compression strain, the ratio of average stress in the rectangular compression block to the specified concrete strength ( $\alpha_1$ ), the ratio of depth of rectangular compression block to depth to the neutral axis ( $\beta_1$ ), and the strength reduction factor ( $\phi$ ). The following table shows the values for these limits or provides the applicable code reference.

# VisualAnalysis 19 User's Guide

	Strain Limit	$\alpha_1$	$\beta_1$	$\phi$
ACI	0.0030	0.85	(22.2.2.4.3)	(21.2.1)
CSA	0.0035	(10.1.7)	(10.1.7)	$\phi_c = 0.65$ $\phi_s = 0.85$

Figure 3 shows a typical interaction diagram that is generated by VisualAnalysis. The interaction diagram is limited by the maximum axial compressive strength at the top ( $\phi P_{n,max}$ ) and by  $\phi P_n = 0$  at the bottom (i.e. combined axial tension and flexure is not considered). Therefore, the solid green line in Figure 3 represents the diagram that is used for design while the dashed green lines are disregarded. Both  $M_u / \phi M_n$  and  $P_u / \phi P_{n,max}$  are checked when determining the unity value for a column that experiences axial compression combined with uniaxial bending.  $M_u / \phi M_n$  will control at low axial loads with high moment (shown in blue in Figure 3) while  $P_u / \phi P_{n,max}$  will control at high axial load with low moment (shown in red in Figure 3).

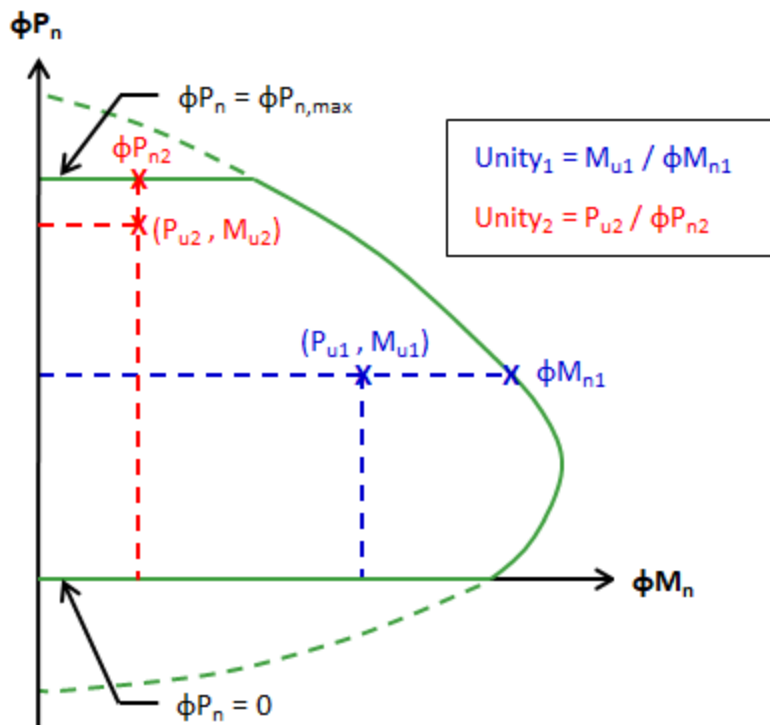

Figure 3: Interaction Diagram for Design

## Axial Compression & Biaxial Bending

### Parme Equation

For rectangular and square columns (with both circular and square reinforcement patterns), biaxial bending is considered using the Parme equation to determine the column's Axial Compression + Biaxial Bending unity value.<sup>1</sup> The factored moment capacities about z-axis ( $\phi M_{nz}$ ) and y-axis ( $\phi M_{ny}$ ) are determined at the  $P_u$  axial load. The Parme equation has the following form:

$$Unity = \left( \frac{M_{uz}}{\phi M_{nz}} \right)^{\log(0.5)/\log(\beta)} + \left( \frac{M_{uy}}{\phi M_{ny}} \right)^{\log(0.5)/\log(\beta)}$$

where:

$M_{uz}$  = Factored moment about the section's z-axis.

$\phi M_{nz}$  = Factored uniaxial moment capacity about section's z-axis at  $P_U$

$M_{uy}$  = Factored moment about the section's y-axis

$\phi M_{ny}$  = Factored uniaxial moment capacity about section y-axis at  $P_U$

$\beta$  = User specified Parme equation factor ( $0.5 < \beta < 1.0$ )

## Moment Resultant

Circular columns have the same interaction diagram for the z-axis and y-axis and at any angle between these two axes. Therefore, resultant of the biaxial moments can be used to determined the Axial Compression + Biaxial Bending unity value of the circular column as expressed in the following equation:

$$Unity = \frac{\sqrt{M_{uz}^2 + M_{uy}^2}}{\phi M_n}$$

where:

$M_{uz}$  = Factored moment about the section's z-axis.

$M_{uy}$  = Factored moment about the section's y-axis

$\phi M_n$  = Factored uniaxial moment capacity at  $P_U$

## Shear and Torsion Design

VisualAnalysis designs columns for one-way shear along the principle axes taking into consideration the effects of axial load on the cross-section. **The effects torsion are neglected for columns.** The shear unity check is performed at all result locations along the column and the maximum unity value for the member is reported. Furthermore, VisualAnalysis ensures that the minimum transverse steel area and spacing requirements are met.

### CSA A23.3

The  $\beta$  parameter for shear design is determined using the General Method outlined in the CSA specification. In this method, the longitudinal strain at mid-depth of the cross-section,  $\epsilon_x$ , is computed accounting for the influence of flexure, shear, and axial load. When the cross-section contains at least the minimum transverse reinforcement, the equivalent crack spacing parameter,  $s_{ze}$ , is taken as 300 mm. Otherwise,  $s_{ze}$  is calculated with  $s_z = d_v$  and  $a_g = 0$ , conservatively. The side bars on flexural tension side of the cross-section are accounted for in the calculation of the effective shear depth,  $d_v$ . Since  $\beta$  is a function of the factored design moment, shear, and axial load which can vary along the length of the column, the shear capacity can also vary along the column's length even when the reinforcement remains constant. Therefore, the unity value is checked at numerous locations along the length of the member and the maximum value is reported. In addition to checking the capacity of the column, VisualAnalysis checks the various detailing requirements in the CSA specification including the proportioning of the longitudinal reinforcement on the column's tension side and the compression side.

## Slender Columns

VisualAnalysis considers the effects of slenderness for concrete columns using the moment magnifier method. By default, the moment magnifiers for the strong and weak axes of a column are set to 1.0 in the program. The moment magnifiers must be manually entered for both the strong axis (z) and the weak axis (y) of the column. For nonsway (braced) frames,

the moment magnifier factor is only  $\delta$  while for sway (unbraced) frames the combined  $\delta$  and  $\delta_s$  should be used for the magnifier. While effective lengths for the columns are calculated automatically, the user must specify if the column is apart of a sway frame. Alternatively, the effective length factors can be overridden and manually input. The moments are automatically magnified if the slenderness effects are required to be considered per the chosen design specification. The column design length is assumed to be the clear spacing between beams at each end (note: any internal member forces beyond the column design length are ignored).

## Concrete Column Parameters

Several parameters must be defined to design a concrete column in VisualAnalysis. The design parameters are set in the **Project Manager | Modify** tab when the Design View is selected. After creating a Design Group, choose one of the members that belongs to the group in the Design View to set up the Design Group's Parameters. Since the design parameters apply to all members in the Design Group, it is often best to choose the most conservative condition that applies to any member in the group.

- Concrete**
- Specification** - The Design Specification used to design the members in the Design Group.
  - High Seismic? - (ACI Only, Use Reduced  $\phi$  Factors for Members Resisting Earthquake Effects)**  
Enabling this parameter lowers the  $\phi$  factors as indicated by ACI 318 Section 21.2.4 for members that are designed to resist earthquake effects and are part of a structure that relies on special moment resisting frames or special structural walls to resist earthquake effects. VisualAnalysis relies solely on this parameter in determining whether or not to use reduced  $\phi$  factors (it does not attempt to calculate whether the shear capacity is greater than the shear corresponding to the development of the nominal flexural strength of the member). Only shear  $\phi$  factors are influenced by this parameter for design according to the ACI specification.
  - Member Type** - Indicates the design shape (Beam or Column).
  - Overstrength?** - Causes the Design Group to be designed using overstrength load combinations.
  - Live Load Reduction** - If specified, design checks will only consider result cases with the matching live load reduction. Combinations with live load reduction can be created in the **Load Case Manger**.
  - Disable Checks?** - Causes selected design group to be omitted from design checks.
  - Check Level** - Determines the level of detail reported from design checks. Options are: *To Failure* (Fastest), *Each Limit State*, and *All* (Slowest, but provides the most information).
- Column Reinforcement**
- Reinforcement Pattern** - Layout of longitudinal reinforcement (Rectangular or Round).
  - Longitudinal Reinforcement** - The size, quantity, and yield stress of the column's longitudinal bars.
  - Confining Reinforcement** - The size, spacing/pitch, and yield stress of the column's confining bars.
  - Cover** - Clear cover between outer concrete surface and outer surface of ties or spiral.
  - Splice Type** - Splice method for main longitudinal reinforcement. Used to determine if the longitudinal bars will fit in the concrete column.
  - Use Metric Bars** - Should metric reinforcement be used instead of imperial bar sizes?
- Axial**
- Allow Slender?** - Can the columns exceed the  $KL/r < 100$  limit?
  - Parme Equation Beta** - The beta coefficient to be used when evaluating the Parme interaction equation for combined compression and biaxial bending (value must be between 0.5 and 1.0).
  - Moment Magnifier  $M_z/M_y$**  - The combined delta-ns and delta-s moment magnifier use for the case where sidesway is allowed (unbraced frame). In the case of braced frames, these factors only used delta-ns.

**Manual  $K_z/K_y$**  - Allows the user to manually override the effective length factors for the strong/weak axis.

**$K_z/K_y$  Sidesway?** - Choose if the member is apart of a sway frame in the specified direction.

**Deflections**      **Strong/Weak** - Specifies the type of limit for normal column deflections.

**Size Constraints**      **Limit Depth/Width?** Allows the design search to 'Fail' if the shape is outside of the Min/Max range.

## Concrete Column Design Process

To achieve an adequate design, the Design Group's Parameters of the columns in the model can be manually adjusted until all the design checks pass. Alternatively, the built in optimization feature in VisualAnalysis can be used to iterate through some of the column parameters to find an adequate solution using the following process:

### 1. Create the Columns

In the Model View draw or create the concrete column members.

### 2. Support and Load the Columns

Define support conditions for the model and apply the service level loads to the members. Set the strength design load combinations in the Load Case Manager.

### 3. Specify Preliminary Parameters

Set the preliminary column shapes, dimensions, and material properties. Note that concrete columns must have Standard Parametric cross-sections and all concrete columns in a Design Group must have the same shape and dimensions.

### 4. Analysis and Preliminary Design

VisualAnalysis will automatically analyze the model and perform the appropriate design checks. Simply click on the Results View tab to view the analysis results for the model or the Design View tab to see the design results. VisualAnalysis uses default parameters for concrete column reinforcement that will likely need to be adjusted (see Step 7).

### 5. Create/Modify Design Groups

VisualAnalysis will automatically create groups for members based on material, orientation, length, and/or cross-section. Alternatively, Design Groups can be created or modified manually as explained in the [Groups Category](#).

### 6. Concrete Parameters

For each Design Group, select the appropriate design specification, member type, seismic & overstrength parameters, etc. in the in the [Project Manager | Modify](#) tab in the Design View.

### 7. Define Reinforcement

Manually adjust the reinforcement in the [Project Manager | Modify](#) tab in the Design View. The layout, size, quantity, and yield strength of the longitudinal bars can be set while the size, spacing/pitch, and yield stress of the member's confining/transverse bars can be set. Upon changing the reinforcement for a Design Group, the unity checks are automatically updated in the Design View.

### 8. Design the Group

After selecting a concrete column design group, click the Design the Group button in the Design ribbon. In the Design Selection dialog box, choose a parametric type and set the constraints on the dimensions for the cross-section of the concrete member. Click the Optimize Now button to search for various sections and display the unit value for each section using the reinforcement that was defined in the previous step. Note that VisualAnalysis does not vary the reinforcement for each section and only optimized the size of the parametric shape. If a warning stating "demands could not be satisfied"

appears, then all the sections within the search parameters have a unity value larger than the Unity Success Limit. Enabling the Return all Shapes feature will provide information on every considered section which may be useful for determining why a section failed or was not optimal.

## 9. Select a Section

Once the optimization is complete, select a section from the list and click the Accept Design button. Now the unity value for all members in the design group are displayed using the selected section. The tilde symbol (~) in front of the unity value indicates that the unity checks must be validated with another analysis since the member stiffness and resulting load distribution may have changed.

## 10. Synchronize Design Changes

Click the Synchronize Design button in the Design ribbon to automatically update the model with the new cross-section, re-analysis the model with the new member stiffness, and rerun the design checks with the updated analysis results.

## 11. Verify Unity Ratios

The final step in the design process is to verify that Unity Ratios in the Design View are less than the Unity Success Limit. If member sizes were drastically changed during the design process, final unity ratios can differ from predicted unity ratios because the analysis results may vary significantly.

## Concrete Column Reports

Design reports are available by double-clicking on a member in the Design View, by selecting a member and clicking the Report Selected button in the **right-click** context menu, or by adding tables individually from the Report View. Column reports include both the code checks and the Z-axis and Y-axis interaction diagrams. The results from the strength load cases for each column in the design group are plotted on the interaction diagrams to help the user identify if the columns are passing (all points inside the diagram) or failing (any points outside the diagram). The Concrete Column Parameters used for the Design Group are available with the Member Design Results table by clicking in the table and enabling the Include Parameters setting in the **Project Manager | Select Table** tab.

## Concrete Column Design References

1. Wang, Chu-Kia, and Charles G. Salmon. Reinforced Concrete Design. John Wiley & Sons, 2007.

## 5.13 Concrete Wall/Slab Design

**Requires: Full Design Level**

### Introduction

VisualAnalysis designs reinforced concrete walls/slabs to resist shear and pure bending (the effects of axial forces are not considered for design) according to the following design specifications:

- ACI 318-14
- CSA A23.3-14
- ACI 350-06

Walls/slabs are analyzed and designed using finite element plate/shell elements that have either 3 or 4 nodes. Individual plate elements can be drawn in the Model View or plates can be automatically generated for Areas that are drawn in the Model View. Plate element can be grouped together in Design Meshes to reduce the required amount of data entry and simplify the design of a structure. All of the plates in a Design Mesh must have the same parameters and a Design Mesh cannot contain a mix of manual plates and automatically generated plates. If the "Auto-Mesh Plates?" setting is enabled in the **Project Manager | Modify** tab, Design Meshes are created automatically for plates with similar parameters (material,



orientation, thickness, etc.). Alternatively, design meshes can be created or modified manually.

## Concrete Wall/Slab Section Definition

### Local Coordinate System

Plate elements for walls/slabs have a local coordinate system which is used when defining the rebar for the design mesh. The local x-direction and y-direction are in the plane of the plate and the z-direction is normal to the plate according to the right-hand-rule as shown in Figure 1. The top of the plate is defined in the +z-direction while the bottom of the plate is defined in the -z-direction (top and bottom are used to define reinforcement mats, rebar cover, exposure classifications, etc.). The local axes for individual plates can be displayed in the Model View while the local axes for the Design Mesh can be displayed in the Design View.

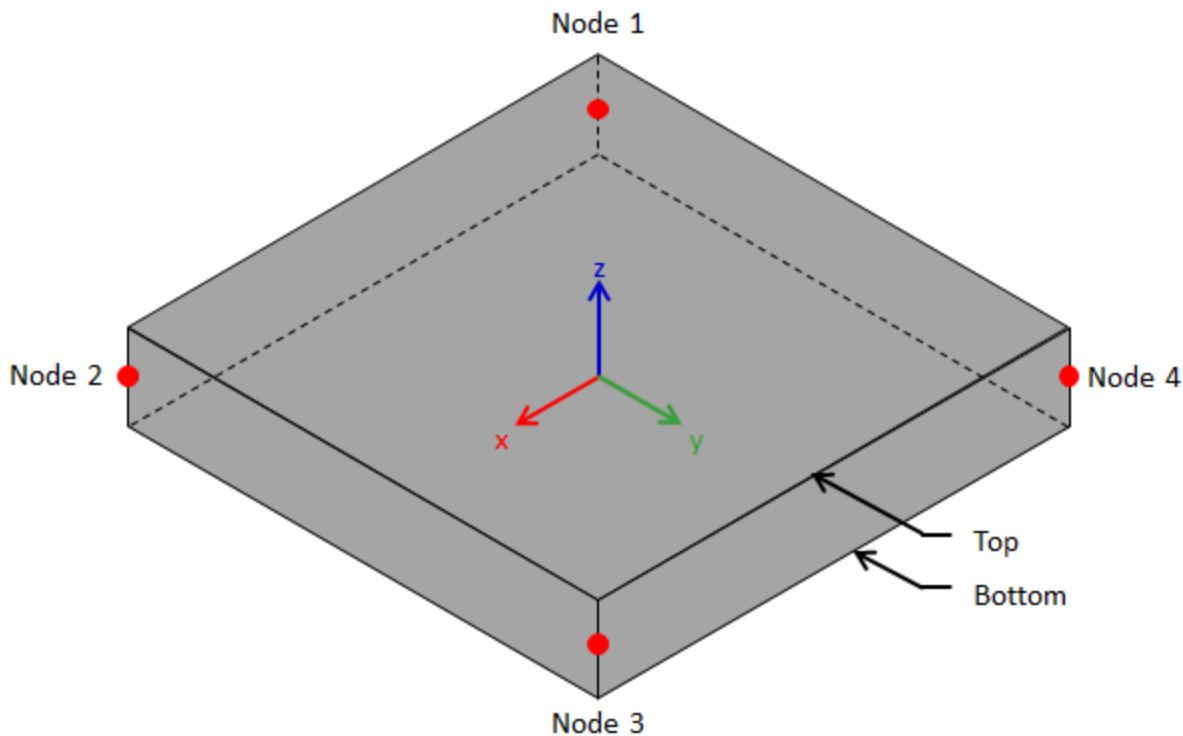

**Figure 1: Local Axes for Plate Finite Element**

### Reinforcement

The wall/slab reinforcement is specified for each design mesh. Therefore, design meshes should be created for each region where the size and/or spacing of the reinforcement will change. Rebar is oriented with the local coordinate system for the Design Mesh. Using the "Direction of x-bars" feature in the **Project Manager | Modify** tab, the local x-axis for the Design Mesh are aligned with a global coordinate or custom direction. Rebar is specified as a bar size and spacing for each bar layer in each direction (the minimum steel requirements are checked according to the selected design specification). The "Are x-bars Top Layer?" feature can be used to specify which layer of reinforcement in mat is closest to the top of the of the wall/slab(see Figure 2 & 3). The location with rebar through the thickness of the wall/slab is set by adjusting the values for the top and bottom cover. While a single mat of reinforcement only has two layers of steel (local x-bar and local y-bars), a double mat has the following four layers:

1. Top layer local-x bars
2. Top layer local-y bars

# VisualAnalysis 19 User's Guide

3. Bottom layer local-x bars
4. Bottom layer local-y bars.

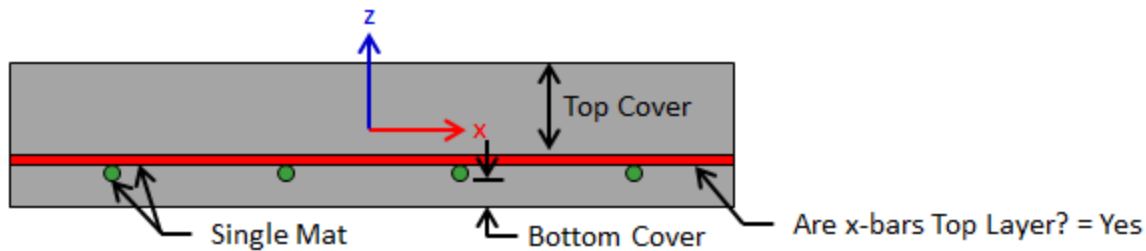

**Figure 2: Reinforcement Layout for Design Mesh - Single Mat**

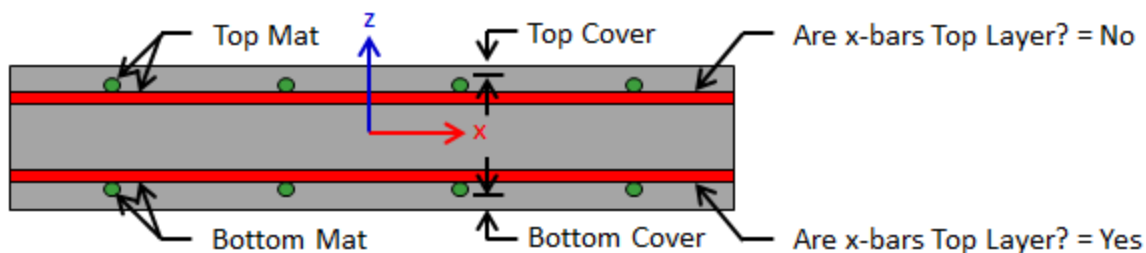

**Figure 3: Reinforcement Layout for Design Mesh - Double Mat**

## Bending Design

VisualAnalysis uses strain compatibility, equilibrium, the elastic-perfectly plastic constitutive law for steel, and the Whitney rectangular stress distribution for concrete to determine the flexural capacity of concrete plate elements. In determining the capacity of a wall/slab, the ACI and CSA design specifications use slightly different values for the maximum concrete compression strain, the ratio of average stress in the rectangular compression block to the specified concrete strength ( $\alpha_1$ ), the ratio of depth of rectangular compression block to depth to the neutral axis ( $\beta_1$ ), and the strength reduction factor ( $\phi$ ). The following table shows the values for these limits or provides the applicable code reference.

	Strain Limit	$\alpha_1$	$\beta_1$	$\phi$
ACI	0.0030	0.85	(22.2.2.4.3)	(21.2.1)
CSA	0.0035	(10.1.7)	(10.1.7)	$\phi_c = 0.65$ $\phi_s = 0.85$

## Moment Demands

Slabs/walls that experience two-way action have both bending moments ( $M_x$  and  $M_y$ ) and twisting moments ( $M_{xy}$ ). The twisting moments may cause the maximum bending demand to not coincide with the X or Y reinforcing directions. To ensure that the slab/wall has adequate strength in all directions, VisualAnalysis uses the method by Wood and Armer as explained by MacGregor and Wight<sup>1,2</sup> to design the reinforcement. The following equations are used to calculate the design moments which are obtained from Wood and Armer when  $k=1.0$ . According to MacGregor and Wight,<sup>2</sup>  $k=1.0$  is the best choice for a wide range of moment values.

$$M_{x+} = M_x + |M_{xy}| \geq 0$$

$$M_x^- = M_x - |M_{xy}| \leq 0$$

$$M_y^+ = M_y + |M_{xy}| \geq 0$$

$$M_y^- = M_y - |M_{xy}| \leq 0$$

## Shear Design

VisualAnalysis designs walls/slabs for shear where the effects of axial load are not considered. The shear capacity for each plate in the design mesh is checked and the maximum unity value is reported for the mesh. While, VisualAnalysis checks one-way shear for the concrete plate elements in the local x-direction and y-direction, punching shear is not considered in the design (to design for punching shear, use [ConcreteBending](#) or [VisualFoundation](#)). For the CSA A23.3 design specification, the  $\beta$  parameter for shear design is determined using value for special member types ( $\beta = 0.21$ ) when the plate thickness does not exceed 350 mm. Otherwise, the Simplified Method is used to determine  $\beta$  according to the design specification.

## Wall/Slab Parameters

Several parameters must be defined to design a concrete wall/slab in VisualAnalysis. The design parameters are set in the [Project Manager | Modify](#) tab when the Design View is selected. After creating a Design Mesh, choose one of the plates that belongs to the group in the Design View to set up the Design Mesh's Parameters. Since the design parameters apply to all plates in the Design Mesh, it is often best to choose the most conservative condition that applies to any member in the mesh.

### Concrete

**Mesh Name** - Specify the name of the design mesh

**Plates** - Total number of plates in the mesh and the names of the plates

**f'c** - The 28-day concrete compressive strength (modify this value in the Model View)

**Thickness** - The thickness of the wall/slab (modify this value in the Model View)

**Specification:** The Design Specification used to design the plates in the Design Mesh.

**High Seismic? - (ACI Only, Use Reduced  $\phi$  Factors for Members Resisting Earthquake Effects)**

Enabling this parameter lowers the  $\phi$  factors as indicated by ACI 318 Section 21.2.4 for members that are designed to resist earthquake effects and are part of a structure that relies on special moment resisting frames or special structural walls to resist earthquake effects. VisualAnalysis relies solely on this parameter in determining whether or not to use reduced  $\phi$  factors (it does not attempt to calculate whether the shear capacity is greater than the shear corresponding to the development of the nominal flexural strength of the member). Only shear  $\phi$  factors are influenced by this parameter for design according to the ACI specification.

**Overstrength?** - Causes the Design Mesh to be designed using overstrength load combinations.

### Minimum Steel

**Min Steel Ratio** - Select which criteria should be used for minimum steel ratio (shrinkage & temperature, walls, user specified, or none).

**Min Steel for Flexure** - Should the minimum steel ratio in the code reference be used for the flexural reinforcement that is in tension in the model?

**Max Spacing Limits** - Select which criteria should be used for the maximum reinforcement spacing limits (one-way slab, two-way slab, walls, none).

**Min. Steel Placement** - Select where the minimum steel should be placed in the wall/slab (all steel in top, all steel in bottom, split steel between top & bottom, or use the minimum steel requirement for both the top and bottom).

**Are x-bars Vertical?** - Specify the orientation of the x-bars. This parameter is used for the wall

minimum steel calculations.

- Reinforcement (General)**
- Use Metric Bars** - Should metric reinforcement be used instead of imperial bar sizes?
  - Steel Fy** - Yield stress for the longitudinal reinforcement in the wall/slab
  - Direction of x-bars** - Specify the direction for the x-bars in the global coordinate system
  - Bar Configuration** - Double Mat (two layers) or Single Mat (single layer)
  - Top/Bottom Cover:** Clear distance to outer bars from face of the wall/slab
- Reinforcement (Single or Top/Bottom Mat)**
- X/Y Size** - Rebar size for this mat and direction
  - X/Y Spacing** - Rebar on center spacing for bars in this mat and direction
  - Are x-bars Top Layer?** - Are the x-direction bars the top layer (local +z side) of the mat?
- Environmental Structures**
- Top Exposure** - Exposure classification for the top (local +z) side of the wall/slab
  - Bottom Exposure** - Exposure classification for the bottom (local -z) side of the wall/slab
  - Has Movement Joints?** - Does the slab have movement joints? If so, specify the joint spacing

## Concrete Wall/Slab Design Process

To achieve an adequate design, the Design Mesh's Parameters can be manually adjusted until all the design checks pass. Alternatively, the built in optimization feature in VisualAnalysis can be used to iterate through some of the parameters to find an adequate solution using the following process:

### 1. Create the Wall/Slab

In the Model View draw areas or plates to create the walls/slabs.

### 2. Support and Load the Walls/Slabs

Define support conditions for the model and apply the service level loads to the elements. Set the strength design load combinations in the Load Case Manager.

### 3. Specify Preliminary Parameters

Set the preliminary thickness and material properties (note: concrete walls/plates in a design group must have the same thickness and material properties).

### 4. Analysis and Preliminary Design

VisualAnalysis will automatically analyze the model and perform the appropriate design checks. Simply click on the Results View tab to view the analysis results for the model or the Design View tab to see the design results. VisualAnalysis uses default parameters for concrete wall/slab reinforcement.

### 5. Create/Modify Design Meshes

VisualAnalysis will automatically create meshes for elements based on material, orientation, length, and/or thickness. Alternatively, Design Meshes can be created or modified manually using the options in the Design Ribbon.

### 6. Concrete & Minimum Steel Parameters

For each Design Mesh, select the appropriate design specification, overstrength parameters, minimum steel requirements etc. in the in the [Project Manager | Modify](#) tab in the Design View.

### 7. Define Reinforcement (General)

Specify the general reinforcement parameters (bar type, steel Fy, Direction of x-bars, bar configuration, and cover) in the

[Project Manager | Modify](#) tab in the Design View.

## 8. Design the Mesh (Optimize Slab Reinforcement)

After selecting a Design Mesh, click the Design the Mesh button in the Design ribbon. In the Optimize Slab Reinforcement dialog box, choose which layers of reinforcement are to be optimized and set the reinforcement range and bar spacing limits (note: each layer can be optimized individually if the parameters need to be different for each layer). Click the Optimize Now button to search for the optimal bar and size and spacing for each layer of reinforcement that was chosen. Upon clicking "Done" the reinforcement parameters for the design mesh are updated with the optimized reinforcement. VisualAnalysis automatically re-calculates the unity values for each element based on the new reinforcement parameters. Since the Design the Mesh feature does not influence the wall/slab thickness or concrete strength (i.e. the stiffness of the slab does not change) the design does not need to be synchronized (as is the case when using the Design the Group feature for members). Since the Design the Mesh feature does not significantly change the reinforcement depth, it is not an effective tool to design for shear. Therefore, the thickness and/or strength of the concrete should be adjusted manually in the Model View until the shear checks pass before optimizing the reinforcement for flexure.

## 11. Verify Unity Ratios

The final step in the design process is to verify that Unity Ratios in the Design View are less than the Unity Success Limit and to ensure that no errors or warnings are present in the model.

## Reports

Double-clicking on a Design Mesh in the Design View will generate a report for the plate elements in the mesh. Results for every plate element can be shown, which may produce lengthy reports, or only the controlling results can be displayed using the Extreme Rows parameter in the [Project Manager | Selected Tables](#) tab. Report can include the input parameters, the design details, and the code checks showing demand, capacity, intermediate values, and unity check results. A design specification reference is provided for each unity check and any errors or warnings for the Design Mesh are included in the report.

## Concrete Wall/Slab Limitations

- **Flat Slabs Only** - There are no provisions for waffle slabs, ribbed slabs, or column capitals. Only flat walls or slabs are checked.
- **No In-Plane Forces** - Walls/slabs are only designed for pure-bending and out-of-plane shear (i.e. shear wall and bearing wall design is not supported). A warning will appear if 'significant' in-plane forces are detected in the model.
- **No Critical Section for Moment and Shear** - Walls/slabs does not consider critical section for moment at the face of the support or shear at 'd' from a support point. The software does not detect or allow you to specify support locations.
- **No Shear Steel** - Shear steel cannot be specified for walls/slabs. Therefore, all shear strength comes directly from the concrete.
- **No Punching Shear** - Punching shear is not considered for slabs/walls in VisualAnalysis. To design for punching shear, use [ConcreteBending](#) or [VisualFoundation](#).
- **Foundations & Footings** - While slabs/walls can be supported by soil springs, VisualAnalysis does not perform stability checks for footings or foundations. Use VisualFoundation for this task.

## Concrete Design References

1. Wood, Randal H. and Armer, G. S. T., "The Theory of the Strip Method For Design of Slabs," Proceedings, Institution of Civil Engineers, London, Vol. 41, October 1968, pp. 285-313.
2. MacGregor, James G., and Wight, James K., "Reinforced Concrete: Mechanics and Design," Pearson, 2012.

## 6 Report

### 6.1 How To

#### 6.1.1 Working in Report View

##### Create a Report

- Use the **Tools | New Report** menu command, to a new, **empty report**
- **Click** the **Report View** tab, this will show you the last report you were viewing.
- Use the **Report Selected...** command from a graphic window's context menu.
- **Double-click** an item in a **Result View** or **Design View** to get a quick report
- Use a style from the **Reports** tab in **Project Manager**, when a Report View is active.

 **If your reports get long enough**, VisualAnalysis may stop trying to recreate the report automatically on every change you make to tables, filters and settings. This allows you to rapidly define the report. When you are ready, click the **Create Report** button displayed near the top of the Report View.

##### Modify Report Filters

Use the **Modify** tab to change how the report is filtered. There is also a 'clear report filters' button in the report toolbar as a quick way to reset all the filters.

##### Load Case Selection

You can define which load cases to include, all or those selected from a list, which will affect load tables.

##### Result Case Selection

You can define which result cases to include for analysis-result tables, again by all or those selected. The result-case selection table can be sorted on different columns and allows for standard multiple-selection with the **Ctrl** key to toggle a row, or **click** the first item and then **Shift+Click** the last item in a range.

##### Selected Item Reports

Similarly, model objects can be included or excluded by either selection or name filtering. If you choose the 'selection' method, you can toggle back and forth between the Report View and another graphic window to change the selection status and the report will **dynamically update**.

##### Table Operations

To work with a specific table, **click** your mouse within the table. The **Modify** tab will display the table's options and available columns. Note that clicking on a table header will perform sorting. You can rename a table in the modify tab, which is useful if you include a table twice and display different columns in each instance of the table.

##### Changing Column Widths

To change the width of a column, simply use your mouse to **Drag** the dotted line separating columns.

##### Add or Remove Tables

To add tables to a report use the **Add Tables** tab. To remove or **rearrange tables**, use the **Modify** tab to drag them around or click the **X** icon. (If you have a table selected, you can **click in the white-space** of the report to modify the report properties rather than those for a single table.)

## [Sorting Tables](#)

You can sort any table in a report by *clicking* on a column-header.

## [Extreme Rows](#)

One important option on tables that show results, is the ability to compress the table to only rows that contain a minimum or maximum value. If you cannot find the information you need, you can adjust the Extreme Rows Display parameter to 'Show All' to see all of the data in the table.

## [Save a Report with your Project](#)

Quick reports may be generated in a variety of ways. If you close your report, or create a new report this type of report is "lost" (you may always re-create it the way you did originally). However if you edit a quick report or give it a name, it will be automatically saved with your project file! When you re-open your project file you will be able to access it by name from the Command Bar, when the Report View is active. It is a good idea to give these reports a nice name that will make sense to you.

Please note: The report's **data** is not saved, just a **template** (organization, filters, and format) of the report! When you recreate a project report the data is pulled "live" from your model, loads and analysis results. If you wish to **save the data** from a particular model or analysis run permanently you should print it, or save the report as a separate file!

## [Save a Report as a New Style](#)

Save a report that you have customized for use on other and future projects. This preserves the report contents and settings in a data file on your machine, independent of any particular project file. See [File Preferences](#) for names and locations.

## [Save a Report to a File](#)

You may wish to save a report permanently to archive the information it contains. Perhaps you want to use a spreadsheet to further process the numbers in a report. You may also need to edit it in a word processor or email the report to someone. In all these situations, you will use **File | Save Report As** to create a file. Reports may be saved in Rich Text File (.rtf), Plain text (.txt), Comma Delimited (.csv), or Tab Delimited format (.txt). The delimited formats work best for going to spreadsheets.

In the advanced level of VisualAnalysis you can also save the report directly to Microsoft Excel (.xls) format, or work with the **Spreadsheet** tab directly for basic spreadsheet manipulations of the data.

## [Export a Table to a Spreadsheet](#)

*Right-click* within a report table and you can copy it to the clipboard to paste into another program.

Hint: If you routinely use this feature you might wish to customize reports so they import more easily into the spreadsheet. You may turn clear the box for "Use Table Lines" and the box for "No Table Duplicates". These options are found under **Tools | Preferences** under the **Report** tab.

## [Delete a Saved Project Report](#)

Reports that you customize will accumulate within your project so that you can get back to them easily, and they will be

available to others who receive your project file. These report can be manually deleted: first create the report by selecting it from the Quick Report list in the command bar, then use the Modify tab in Project Manager, selecting the **Delete Saved?** option. The report will be thrown out as soon as another report is generated, or the project is closed.

## [Print a Report](#)

Use **File | Print** to print the active Report View or **File | Print Preview** first to verify how it will appear.

If you need to make some changes before printing, use **File | Page Setup**, or **Tools | Preferences** on the **Report** tab or **Font** tab.

## Member Results at Offsets

There are two types of member result tables: the normal is very concise, showing just the range of forces, stresses, or displacements as one row for each element. The other type contains the word "Detailed" in the title, and allows you to see member results at a specified number of offsets along the member's length.

## [Change Table Properties](#)

To modify an individual table or summary, **Click** within the report section you wish to modify.

## Modify Table Columns

**Click** within any report table, and it appears in the **Selected Table** tab of Project Manager. The included and available columns appear in a checked-list. You can check or uncheck columns, and rearrange the included columns by **dragging** them up or down within the list.

## [Insert a Picture](#)

You may paste any image from the Windows clipboard. This is a good way to get your current Result View included in a report. Use **Home | Copy** when the Result View is active, and then switch to the Report View, position the cursor, and choose **Home | Paste**. Once the image is in the report, you may be able to resize it by selecting it and **Dragging** one of the corners with your mouse. (Any graphic view may be copied to the clipboard through Home | Copy.

## 6.2 Reports

Reports in VisualAnalysis are designed to present information in a clear, concise, and organized fashion. Reports can include both text-based and graphical information that can be printed to paper, to .pdf, or saved in a number of different file formats. Graphical information can be inserted into a report using the **Copy** and **Paste** commands or printed directly using the **File | Print** command.

### Report Essentials

- [Tables](#)
- [Saved Styles](#)
- [Report Notation](#)
- [Member Graphs](#)

### How To

- [Working in Report View](#)



## Custom Report Logo

The report may be customized to include your own (company) logo in the header. All you need to do is create a logo image: ReportLogo.png or ReportLogo.jpg, and place it in the IES\Customer folder, which you can access via the **Tools | Custom Data** toolbar command. The image should be kept to less than 5 times wider than it is tall. It will be scaled to fit in the header area, but wide images may cause other text to start wrapping or get truncated. If the image works you'll see it in the report/preview immediately after restarting VisualAnalysis. This feature is also available in other IES tools.

## 6.3 Tables

In VisualAnalysis, tables are used to report information in a clear and concise manner. The tables available for the report are listed in the **Project Manager | Add Tables** tab when the Report View is active. Tables fall into one of five categories (Project, Structure, Load, Result, and Design) and will automatically appear or disappear depending on the items in the model (elements, loads, etc.) and the available analysis and design results. Hover the mouse over a table in the list to view its description.

### Table Types

- **Project Tables** are used to document the project wide information for the model including a Model Summary, Bill of Materials, Model Check Information, Project Settings, Service Load Cases, Factored Load Combinations, etc.
- **Structure Tables** are used to document the input data for various model objects including Nodes, Members, Plates, Cables, Spring Supports, Areas, etc. Also, the Materials, Section Properties, and Member Analysis Properties can be reported.
- **Load Tables** are used to document every load applied to the model in each service load cases including Nodal Loads, Member Loads, Generate Member Loads, Plate Loads, Area Loads, etc.
- **Result Tables** are used to document the analysis results for the members in the model including Node Results, Node Reactions, Member Displacements, Member Forces, Member Stresses, Plate Global Forces, Plate Local Forces, etc. Results may be available in both 'local' and 'global' directions and in a variety of extreme or min/max configurations.
- **Design Tables** are used to document the Design Groups, Connection Groups, Plate Design Groups, Member Design Results, Plate Design Results, Member Unity Checks, etc. These tables are used to document the demand, capacity, unity checks, show intermediate calculation values, controlling code references, etc. Note: Design Tables are not available for VisualAnalysis Simple.

### Adding & Removing Tables

To add a table to the report, simply **drag** the table from the **Project Manager | Add Tables** tab to the desired location in the report or **double-click** on the table to insert it at the end of the report. A list of the report's Included Tables is shown in the **Project Manager | Modify** tab which can be rearranged by **dragging** them with the mouse. To remove a table from the report, click the X next to the table in the Included Tables list or **right-click** on the table in the report and select Remove.

### Modifying Tables

Tables can be modified using the Report Settings or Model Filters in the **Project Manager | Modify** tab. The Report Settings are used to specify which Service Cases and Result Cases to include in the report while the Model Filters are used to filter the items that are included in the report (such as Nodes, Members, Design Groups, Connection Groups, etc.). Tables can also be modified by clicking on the tables in the report. **Click** the column header to sort the column, **drag** the column header to rearrange the columns in the tables, or **drag** the column borders to adjust the column widths.

## Selected Table

**Click** within a table to select the table and activate the **Project Manager | Selected Table** tab. In this tab, the Title can be modified, the columns can be sorted, and the page width can be defined. Choose which columns are included in the table under the Columns to Display section and drag the columns in this section to rearrange them in the report.

## Selected Table Extremes

Certain tables have the Selected Table Extremes option available in the **Project Manager | Selected Table** tab. The following parameters are used to set how the information is filtered in the selected table.

- **Extreme Rows** - Set to show the Extreme Rows Only for the table or to Show All (which can lead to lengthy reports that may need to be filtered by result cases or reported items to be manageable).
- **Included Rows** - Specify how the extreme rows are considered.
  - **Max and Min** - Keep only the max and min values.
  - **Max** - Keep only the max value.
  - **Min** - Keep only the min value.
  - **Max/Min (when opposite sign)** - Keep the max and min values, if different signs, else keep the most extreme.
  - **Extreme** - Keep only the most extreme value, positive or negative.
- **Applies To** - Specify if the extreme rows be kept on a table wide basis or by each item in the table.
- **Consider Zero as Extreme** - Specify if zero should be considered an extreme value.

## 6.4 Saved Reports

Both Project Reports and Report Styles can be created and saved in VisualAnalysis. While Project Reports are saved in the .vap project file, Report Styles are saved in the [Customized Data Folder](#) and can be used for multiple Projects. VisualAnalysis also includes a few default IES Report Styles.

### Project Reports

#### Save a Project Report

After creating a report, go to the **Project Manager | Reports** tab, name the report, and click the Save in Project button. This saves the Project Report in .vap project file for easy access.

#### Delete a Project Report

To delete a Project Report, click the X next to the report in the **Project Manager | Reports** tab. The **Home | Undo** command can be used to restore a deleted report.

### Report Styles

#### Save a Report Style

After creating a report, go to the **Project Manager | Reports** tab, name the report, and click the Save as Style button. This saves the Report Style in the [Customized Data Folder](#) in an XML file and makes the style available for use in other VisualAnalysis projects.

#### Create a Report from a Style

To create a Report from Report Style, Simple **double-click** on the saved report in the **Project Manager | Reports** tab or **drag** the saved report onto the Report View.

## Update a Report Style

To update a Report Style, create a report based on the style, modify the report as need, and save the style using the original name.

## Delete a Report Style

To delete a style, click the X next to the style in the **Project Manager | Reports** tab or manually delete the style in the [Customized Data Folder](#) in an XML file. The only way to restore a style once it is deleted is to import a backup copy of the style file.

## Share Report Styles

Report Styles can be shared by copying the XML style file (found in **Tools | Custom Data**) to the same location on another computer. The XML file can be manually edited to merge styles from other users. Always save a back up copy of the XML file before doing any manual customization so the file can be restored if it gets corrupted.

## 6.5 Report Notation

The following table describes the notation used in the reports and through out the program. Note: Lower-case x, y, z represent the local coordinate system (see [members](#) and [plates](#)) and upper-case X, Y, and Z represent the global coordinate system. For members, x is the axial direction.

Column Heading	Description
% Damping	Damping factor used in modal superposition
%ly, %lz, %J	Percent of stiffness to use during analysis of cracked materials
Action	Member behavior: normal (two-way), tension-only, or compression-only
Alpha	Thermal coefficient of expansion, for a material. Also, orientation of principal axes for asymmetric shapes.
Area	Area of plate
Auto Mesh	Signifies whether an area is meshed with plates
Ax	Cross sectional area
Beta	Beta Angle - rotates the member local coordinates, also an input parameter for time history analysis, also "Parme Beta" in concrete design
Cases	Number of load cases included in the combination
Category	Type of shape within a database
Cluster Factor	Cluster factor used in modal superposition
Combination Method	Response case modal combination method
Connect Crossings?	When mapped to the FEA model, should the member be split and connected to members crossing it.

# VisualAnalysis 19 User's Guide

<b>Column Heading</b>	<b>Description</b>
D. Mass	Lumped translational mass
Delta	Input parameter for time-history analysis.
Delta t	Time step interval for time history analysis.
Density	Weight density of a material (also Gamma)
Design Spectrum	Name of design spectrum
Dim. 1 - Dim. 6	Cross section dimensions, meaning depends on type of shape
Direction	Global direction of a nodal load or member load. Direction of spring support. Also direction of a Semi-Rigid connection (advanced only)
Displacement	Displacement result in spring
DX, DY, DZ	Displacement in the global X, Y, or Z direction
Dx, Dy, Dz	Local member displacements in the x, y, or z direction
Dx1, Dy1, Dz1, Dx2, Dy2, Dz2	Displacement release in the local x, y, or z direction at the starting(1) or ending(2) node
Elasticity, or E	Modulus of elasticity or Young's Modulus
Elements	Number of members or elements in the group or mesh
End Offset	Distance from the starting end of the member
End zone 1, End zone 2	Type of end zone (normal, panel, or rigid) at the start(1) or end(2) of a member.
Ez Width. 1, Ez Width. 2	Width of the end zone at the start(1) or end(2) of a member
Ez Stiffness 1, Ez Stiffness 2	Percent of the member stiffness to use in the end zone region at the start(1) or end(2) of a member
Equation	Equation name or description
Exclusive	True or false, indicates whether the load case requires unique building code combinations, as for directional wind or seismic load sources.
Extreme Item	Type of results
f(Hz)	Frequency of vibration in cycles per second
fa	Axial stress in a member (tension is positive, compression is negative).
fby(+z), fby(-z)	Bending stress in a member bending about the section y-axis, at the extreme z fiber
fbz(+y), fbz(-y)	Bending stress in a member bending about the section z-axis, at the extreme y fiber
fc max, fc	Extreme value of combined bending and axial stress at the section "corners", may be incorrect for non-

Column Heading	Description
min	rectangular shapes!
fc(+z+y), fc(+z-y), fc(-z+y), fc(-z-y)	Superimposed bending and axial stresses at section "corners", <b>may be incorrect</b> for round, tee, L, and other shapes without corners at a 'bounding rectangle' drawn around the shape. See <a href="#">Member Results</a>
fvy, fvz	Average shear stress on a member: $V_y/A$ and $V_z/A$ , respectively. These are not the "extreme" shear forces on the cross section as VisualAnalysis cannot calculate that information.
Final Shape	Designed member size or section name
Fix DX, Fix DY, Fix DZ	Supported against translation in X, Y, or Z
Fix RX, RY, RZ	Supported against rotation about X, Y or Z
Force	Reaction force in spring supports.
Framing	Member 'category' (beam, column, or brace) used to exclude braces from area loads
Fx	Axial force in a member (tension is positive, compression is negative).
FX, FY, FZ	Reaction force in the global X, Y, or Z direction
Gamma	Density of a material ( $\gamma$ )
Iy, Iz	Moment of inertia about the local axis
J	Torsion constant
L.FX, L.FY, L.FZ	Sum of applied loads in the global X, Y, or Z direction
L.MX, L.MY, L.MZ	Total moment about X, Y, or Z of applied loads, taken about the global origin
Length	Length of member
Load Case	Name of a load case
Load Source	Type of loads in this load case
Loads	Number of loads in the service load case
Location	Node name or plate centroid where plate results are located
Magnitude	Force, moment, displacement or rotation of a nodal load. Value of member load.
Magnitude1, 2	Starting or ending distributed member load
Mass Case	Static load case included in a response analysis
Mass Dir.	Direction of gravity for loads in response analysis
Material	Material type name
Max Mass	The maximum participating mass (X Mass, Y Mass or Z Mass) for the mode shape. The value is converted to a force.
Max, Min	Principle direction membrane stresses in plates

# VisualAnalysis 19 User's Guide

<b>Column Heading</b>	<b>Description</b>
Principal	
Member	Member name
Member Loads	Number of member loads in the service load case
Modal Method	Method used to analyze for mode shapes
Mode	Mode number
Modes Used	Number of modes included in a response analysis
Moment	The semi-rigid connection moment value. Advanced level only
Mx	Torsional moment in a member
Mx, My	Distributed plate moment on local x or y face
MX, MY, MZ	Nodal reaction moment in the global X, Y, or Z direction, Distributed plate bending moment transformed to global directions
Mxy	Distributed twisting moment on plate edge
MYX	Distributed plate twisting moment transformed to global directions
My, Mz	Bending moment in a member about local y or z
Name	Name of the Design Group or Mesh
Nodal Loads	Number of nodal loads in the service load case
Node	Node name.
Normal	Direction of vector perpendicular to a plane (e.g. area or plate)
Offset	Distance from the starting end of the member, for loads or results.
Offset y, Offset z	Member centerline offset in the local y or z direction.
One Way	Normal, tension-only or compression-only member or spring support
Parameters	Are design parameters set and valid?
Path	Hierarchical category for shape or material from the database
Phi	Angle to the global Z axis for a spherical coordinate
Plane	Top, bottom, or mid-plane of plate element
Plate	Plate name
Plate Loads	Number of plate loads in the service load case
Points	Number of data points in a design spectrum
Poisson	Poisson's Ratio, $\nu$
Pressure 1 - Pressure 4	Plate pressure load at node 1 through 4
Projected	Is the load on the projected length?

Column Heading	Description
Power	Semi-rigid connection power factor, advanced level only
R	Distance from the origin in polar coordinates
R. Mass	Lumped rotational mass
R.FX, R.FY, R.FZ	Sum of reactions in the global X, Y, or Z direction
R.MX, R.MY, R.MZ	Total moment about X, Y, or Z of reactions, taken about the global origin
Result Case Name	The name of the result case for a specific load case.
Result Type	Indicates the type of the result case (1 <sup>st</sup> order, 2 <sup>nd</sup> order, or dynamic time results)
Results	Load case has valid analysis results?
Rho	Spherical coordinate
RX, RY, RZ	Rotation in the global X, Y, or Z direction
Ry, Rz	Member end reaction result (like shear Vy and Vz, respectively, with a different <a href="#">sign convention</a> )
Rx1, Ry1, Rz1	Rotation release, local x, y, or z at the starting node
Rx2, Ry2, Rz2	Rotation release, local x, y, or z at the ending node
Scale Factor	A load factor applied to an entire load combination equation. (e.g. .75 in .75(1.4D + 1.7L + 1.2W))
Section	Section name of a shape in a database
Self Weight	Includes self-weight of model
Self X, Y, or Z	Factor on self-weight in the X, Y, or Z direction
Service	Checked for design serviceability
Shear Ay, Shear Ay	Shear Area, area that participates in shear resistance (i.e., the web on a wide flange) Ignored if zero.
Shear Modulus	Material property, G, a function of Elasticity and Poisson's ratio.
Sigma x, Sigma y	Membrane normal stress perpendicular to the local x or y face of a plate
Sigma X, Sigma Y, Sigma Z	Membrane normal stresses in plates transformed to global directions
Span/Dy, Span/Dz	Ratio of member element length to local deflection in the y or z direction
Spring	Spring support name
Stiffness	Stiffness of spring
Stiffness 1, Stiffness 2	Semi-rigid connection stiffness parameters, advanced level only

# VisualAnalysis 19 User's Guide

Column Heading	Description
Strength	Load case is checked for design strength. Concrete or masonry material compressive strength.
Sy(+z), Sy(-z)	Section modulus about local y, at the extreme z fiber
Sz(+y), Sz(-y)	Section modulus about local z, at the extreme y fiber
T Delta	Change in temperature on a member or plate
T Gradient	Gradient temperature through a member or plate
T(sec)	Period of vibration in seconds
Taper Depth	Depth of member at end of taper
Taper End	Distance from the start of member to end taper
Taper Start	Distance from the start of member to begin taper
Taper Type	Type of member taper
Tau Principal	Principal shear stress in a plate
Tau xy	In-plane shear stress on a plate
Tau XY, YZ, or ZX	Membrane shear stresses in plates transformed to global directions
Therm. &alpha	Thermal coefficient of expansion, greek character, alpha.
Theta	Theta Angle. Used in polar or spherical coordinates.
Thickness	Thickness of plate element
Time	The time for a time-history result case, this may be a time-step or an actual time in seconds, advanced level only
Type	Type of spectrum. Design code or specification.
Unity	Unity check ratio ( $\leq 1$ is good, $> 1$ is bad), or actual value/allowable value, or demand/capacity. Used for forces, moments, stresses, deflections or other criteria.
Vx, Vy	Distributed shear force on x or y face of plate
Vy, Vz	Shear force in the local y or z direction in a member
Warping Constant	The warping constant, $C_w$ , a property of the cross section of a member element, advanced level only
Weight	Weight of member or plate
Weight-X, Y, or Z	Self-weight of the model in the X, Y, or Z direction
X C.M., Y, or Z	X, Y, or Z location of the center of mass
X Cosine, Y, or Z	Spring direction cosine in X, Y, or Z
X Dir, Y, or Z	Direction factors for a Response Case
X Mass, Y, or	Contributing mass in the X, Y, or Z direction for a mode shape. It may just be a small portion of the



Column Heading	Description
Z	model that is vibrating. The mass is converted to a force.
X Part, Y, or Z	Modal Participation factors in X, Y, or Z, represents the percentage of structural mass that is 'active' in a mode shape. Building codes often require that you include enough mode shapes in a response analysis to achieve a certain level of participation.
X, Y, Z	Global Cartesian X, Y or Z position in space
X1, Y1, Z1, X2, Y2, Z2...	Global coordinate for node1, node2, etc. for member or plate. Or vertices for areas.

## 6.6 Member Graphs

Member Graphs display detailed diagrams (axial, moment, shear, torsion, deflection, stress, etc.) for members along their length. The results can be displayed for one single member or for a chain of members for a single Result Case. Note: The [Result View](#) can also display on-frame diagrams for all the members in the model Result Filter options.

### Create a Single or Multi-Member Graph

To create a single member graph, simply select a member in the Model, Results, or Design View and switch to the Member Graph view. A different member can be chosen from the dropdown in the [Project Manager | Graph Details](#) tab. To create a multi-member graph, simply select two or more connected members that form a line and switch to the Member Graph view. If the selected members do not have local axes in the same direction, a note will appear on the graph indicating that the member chain has inconsistent local axes.

### Customize a Member Graph

Member graphs can be customized in the Project Manager | Graph Filter tab. The Plot Type can be set to a standard type (2D Beam, 3D Beam, 2D Column, 3D Column, or Deflections) or Custom Plots can be defined. Also, Annotations, Data Points, Grid Lines, and Shadows can be adjusted for the plots. Use the Details Dialog to change specific graphic format information like colors and fonts as well as the basic type of plot used.

### Print a Member Graph

Member graphs can be printed directly using the [File | Print](#) command. The orientation (portrait or landscape) of the graphs can be set using the [File | Page Setup](#) dialog. Use [File | Print Preview](#) to view the page before printing.

### Export a Member Graph

To export a Member Graph to another program, use the [Home | Copy](#) command to copy the Member Graph to the clipboard and then use [Paste](#) to insert the picture into the other application.

## 7 Succeed

### 7.1 History

#### 7.1.1 Version History

Are you upgrading from a previous version? Read about **What** has changed and **Why!**

- [Version 18.0](#), May 2018, Material specifications, performance, incremental
- [Version 17.0](#), March 2017, 64-bit, C#, .NET, WPF, .XML custom data
- [Version 12.0](#), February 2015, miscellaneous, optional 64-bit version
- [Version 11.0](#), January 2014, design specifications updated
- [Version 10.0](#), December 2012, Ice-wind loading, stress-checks, VAConnect link
- Version **9.0**, November 2011, Automated validation (improved accuracy & correctness)
- Version 8.0, October 2010, VisualDesign & VisualTools incorporated
- Version 7.0, October 2009, Areas, Rotation Cube, Reporting improvements
- Version 6.0, August 2007, OpenGL true 3D graphics, Performance-Tuning
- Version **5.50**, July 2005, K-factors, XLS report, Wood SCL checks, CISC design
- Version 5.10, November 2003, Semi-rigid ends, cable elements
- Version 5.00, December 2002, February 2003, Proprietary C++ Analysis Engine
- Version 4.01, December 2000, design specifications updated
- Version 4.00, June 2000, Project Manager, Added .dbs/.dbm customizable databases
- Version 3.50, November 1998, Microsoft MFC, split plates, load combination templates
- Version 3.11, November 1997, VisualTools
- Version 3.10, September 1997, VisualDesign
- Version 3.00, December 1996, 32-bit Windows 95 version, C++,
- Version 2.50, September 1995, VisualStress, VisualSteel, VisualConcrete
- Version 2.10, June 1995, smart naming, custom shapes, 3D rotation, CQC damping
- Version 2.00, December 1994, first suggestions from practicing engineers!
- Version 1.00, May 1994, first commercial release, 16-bit, C++, Borland OWL, Ported SAP IV Engine

#### MSU WinFinite

WinFinite was a non-commercial product, developed by future IES partners, at Montana State University. This was the basis for VisualAnalysis when IES, Inc. was formed and the technology was licensed from the university. Copies of this product were given freely to engineers licensed and living in the state of Montana as well as to CH2M Hill, Inc. for sponsoring the research that went into its development. IES returned over \$100,000 in royalties to the university to support structural engineering education. True to our roots, IES has provided free educational software to schools and students since 1994, see [www.iesweb.com/edu](http://www.iesweb.com/edu) for details.

- Version 1.50, January 1994
- Version 1.00, January 1993

#### 7.1.2 Prior Version 18.0

#### Version 18.0 Changes

After our sweeping rewrite in 17.0, we wanted to make the 18.0 upgrade less jolting. We had a number of building code and material specifications to update and we thought that would be enough. But we get challenged by some customer issues and intrigued by many suggestions and ended up adding over 100 major improvements. Your experience with this version should be faster, easier, and far more productive than in any previous release.

If you are upgrading **from version 12.0** or prior, please read the upgrade notes from [version 17.0!](#)

[Project Files](#): Version 18.0 saves files in a new format that is not readable in prior versions. If you accidentally overwrite an old project that you need in the older version, look in your [History Projects](#) folder.

## Model

- Member **length is displayed while sketching** in graphics
- **DWG** import is now available for CAD file
- Restored **Plane Frame** structure type (removed in 17.0)
- Member **trim command** was added
- Member split at crossing areas and plates
- DXF Import: all members are 'aligned' same direction
- Create soil-spring supports on meshed areas [advanced level]
- Updated steel HSS sections in database
- Splitting members preserves naming scheme
- Ability to swap the ends of a tapered member
- Create tab parametric structures can generate auto-meshed areas
- Context-menu item for supporting selected area edges
- Nodes can be 'snapped' to align with areas
- Circular selection boundary with Shift+Drag
- Improved selection behavior after Generate Copies
- Name filters are more flexible
- Renaming now works with area objects
- Member offsets in global coordinates (e.g. for rotated shapes)
- Member element selection is easier with larger 'hit' area
- Reverse area (local axis, normal direction)

## Load

- Add **multiple-direction nodal loads** in one step
- **Factored loads graphics** available in Result View
- **Canadian NBC load combinations** added
- Linear area loads 'within limits' option for controlling extent
- Area load generation has better warnings and behavior
- Strength-level deflection load combinations added
- Better scaling of load graphics
- Patterned load combinations improved for dead and vertical seismic

## Analyze

- **Factored load graphics** in Result View
- Internal **mechanism detection** displayed as mode-shapes for unstable models

# VisualAnalysis 19 User's Guide

- Member normal stresses are available in Result View
- Analysis is automatic (changed in [version 17](#)), switch to Result View to see results

## Design

- **AISC 360-16 steel** specification
- **NDS 2018 wood** specification with related shapes and materials  
Note: **NDS 2012 was removed, use VA 17.0 if you NEED to use that version of the specification!**
- **ADM 2015 aluminum** specification
- Design wood shapes that are wider than deep
- Smarter intermediate values in wood design report
- Steel: input for torsional unbraced length
- Steel: optional check for constrained axis flexural-torsional buckling (W shapes)
- ASD design groups do not check AISC Direct analysis results
- ASTM A1065 HSS shapes and materials
- Steel composite beam deflections use  $I_{eff} = 0.75 * I_{transformed}$  per AISC commentary
- Right-click to create design group for all ungrouped members
- Torsion limit added to generic stress checks
- More built-up wood shapes added to the shape database e.g. (5) 2x4

## Report

- **Plan Check** member report table (concise structure, results, & design)
- **Add Graphic View** to report with a single click
- **Support Extreme Reactions** table is now available
- Graphic legends have 'numerical' range adjustment
- Springs show in color in Result View for tension/compression
- All possible tables in Modify tab (some are disabled)
- Result-views allow 'A'+click to select meshed plates in an area
- Easy ways to get a blank (new) report
- Table sort-arrows are not so ugly, invisible by default
- Hot-key "S" will convert fly-by text into a Sticky Note
- Added L/delta to displacement report tables
- Empty tables are shown grayed in the table selection tree
- Numerical precision button and units-drop down moved upper-right, above tool bar

## Succeed! (Interface, Performance, Reliability)

- Graphic **wire-frame on members** for easier shape identification
- Project Manager: **drop-lists are activated by clicking anywhere**, not just on arrow
- Graphic nodal reactions pulled away from nodes for clarity
- Full File Path in graphic title block and report headers
- Print Preview is larger and more functional
- Improved IES notification messages (badge icon, persistence, less annoying)
- More **preferences or automatic settings**
  - Grid graphics on startup

- Show View cube/cube axes
- Show table column sort arrows
- Graphics hardware performance/stability option
- DPI setting for graphic copy & paste
- Crash-prevention work, better diagnostics for IES engineers
- Better progress report and/or cancel for long processes
- Numerous **performance boosts** (10x => 10 times faster):
  - Faster FEA analysis (1.8x)
  - Recent file list updates in menu (minor delay on every change)
  - Temp file cleanup (slowed VA after hour of running)
  - Plate auto-meshing (21x)
  - Convert mesh to plates (275x)
  - Clipboard import (95x)
  - DXF import (10x)
  - Background restart is delayed in larger projects
  - Collection validation in large projects (10-20x boost)
  - Plate modifications (43x)
  - Check model for errors
  - Text in graphics
  - Grid drawing graphics (3x)
  - Slab design report (16x)
- Sticky Notes on/off option in Filter tab
- More shared code, internally, for easier maintenance
- Updated 3rd-party components for improved behavior and performance
- Updated Microsoft .NET framework for features and performance
- Additional automatic validation and unit-testing for reliability
- Cleaner user interface, improved panels, menus, colors & layout
- Improved behavior of crash-recovery projects
- Documentation updates and overhaul

## 7.1.3 Prior Version 17.0

### Introduction

**Wow.** From the inside-out, we have mostly rewritten this tool using the latest technologies, hindsight, and lots and lots of customer feedback. From the outside-in, we hope that longtime customers are as comfortable in this version as in previous versions. We also hope you'll spend less time getting work done--fewer mouse clicks, blazing performance, easier to understand commands, and more accurate engineering. And "No", you didn't miss anything we jumped the version number dramatically from 12.0 to 17.0, for several reasons, but there was no version 13, 14, 15, or 16.

### Licensing

If you are running an active license for VisualAnalysis 12.0 (not expired) then this version should "just work". With a network license you may need to enter the path to your license-share folder. If your VisualAnalysis license has expired prior to the release-date of version 17.0, you will need to purchase an upgrade in the [self-service portal](#), or by contacting IES

Sales.

## Legacy Projects

Legacy projects should open OK, if slowly as they require conversion and 'mapping' from old features to new ones. There have been many changes, for very good reasons. Member shapes may 'rotate' to their principal orientation from a legacy project. Most issues and old bugs are handled automatically. Some old features are no longer supported or will have subtle changes, please inspect the project and results carefully.

## Major Changes

We understand that **changes can be disconcerting**. We have worked hard to balance innovation with respecting our many long-time customers. Our hope is that you will embrace the changes, and adapt to them quickly. We think most will make the program much better moving forward. The rest we'll fix, after you tell us what went wrong.

### Main Menu

Gone is the old menu with separate toolbars. The new [main menu](#) (ribbon) is easier to use, but a little different. We think you'll grow to love it within a few days.

### Mapping from Your Model to FEA

We now completely automate the creation of the actual FEA model from yours. When it is time to analyze we check your model, and then construct a correct FEA model from it. If there are errors or warnings you will find those in the Result View, or a Model Check.

This means that we will automatically split and connect [member elements](#) so you do not generally have to worry or think about member elements vs. girders or multi-story columns. Model the members in a way that works best for you. You can split or merge members, and cross them. The trick to the new system is a member property called **Connect Crossings** which is defined per-member, but the **default is Yes**. You should generally allow members to connect. The most common exception is for X-braces, where you typically should not connect them. If you are getting strange instability warnings, make sure this option is turned on for your members!

### New Databases

If you created **custom shapes or materials** in ShapeBuilder 6.0 or directly in VisualAnalysis 12.0 (and prior versions), they will not be available in version 17.0. Those older products used a different database system. You will need to manually recreate those custom databases in the new system. Please see the [Shape Database](#) and [Material Database](#) topics for details.

If you created **Custom Building Code Load Combinations**, you will need to re-create those in the new system. Your old "CodeCombo10.txt" file in your [Custom Data](#) folder can be used to help you re-enter the data into the new system. This only needs to happen once. You can copy the new database to other machines!

The shape database now contains **Virtual Joists and Virtual Joist Girders** which are developed by the  [Steel Joist Institute](#). Their website has information on the basic concept and purpose. You may create models with these shapes, and get steel design-checks as if they were steel beams.

### Structure Types

Everything in VisualAnalysis 17 is now based on a **space frame** structure definition. We removed the academic plane-frame and plane-truss. **Why?**

- Greater reliability (far fewer combinations of things to test)
- Plane structures had unrealistic limitations (like, no shape rotation, no out-of-plane bracing)

- It is still easy to **create plane trusses or plane frames!** (**Shift+Click** a node, [fix all the Z-supports!](#))

## Section Coordinates Clarification

VA 12.0 had some issues dating back to the 1970's and 1990's with regard to the way member cross-sections were defined. In VA 11.0 we clarified the major-principal axis orientation, which many engineers discovered when using single-angle shapes.

 When upgrading legacy projects to VA 17, **shapes that are wider than tall**, or where  $I_y > I_z$ , will get rotated. You can fix this using the beta angle. We don't try to do this automatically because the beta angle also affects end-releases and loads that you may need to address.

Still at issue were inconsistencies in the **geometric** coordinate systems (e.g. x-y in the AISC manual), the **principal** coordinate system (often labeled as 1-2), and a [member element's local coordinate system](#) (in VA this is z-y, because x is always along the length). These three are all related, but not always lined up the way you might expect. It has serious implications for orienting shapes, interpreting member results, and understanding what is meant by "Top" or "Bottom" in [concrete beam design!](#)

In VA 17.0 all member shapes are oriented according to their principal axes for analysis. Custom blobs are defined by  $I_1$  and  $I_2$ , not  $I_z$  and  $I_y$ . **The rule for section orientation is now this:** The shape's major principal 1 axis is always aligned with the member element's local z axis.

Because of this change, we will not import Concrete Design groups "correctly" in all cases, so we do not try. You will need to think about member orientations, and may need to set the Beta angle to orient the member correctly for Top and Bottom terminology.

## Background Analysis & Design

**Where is the Analyze button?** We put your computer to work for you, without slowing you down or degrading the performance of other applications. Trust us! As you build your model we start checking, analyzing, and running unity checks. If you make changes, we start over. The result is this: when you want results, they are generally already available, or you wait a lot less. **When results are not available** view the expandable Status panel in the Result View will show information or errors.

## Removed "Features"

Once in while, features get lost or removed. We take things out to simplify the software or eliminate problems. If one of the following was really important for you, please tell us through a technical support email **what** you want to do and **why**. No guarantees, but we do operate a customer-democracy, not a developer dictatorship!

- Explicit structure type for: Plane Frame, Truss, Grid (*still easy to do, see above*)
- Combined Members: Simplified, see [Connect Crossings](#)
- Analyze Button (see Background Analysis above)
- Saved/Named Views (*rarely used, marginally useful, this may return in some form in the future*)
- Most preferences for Filter settings (*ask for specific ones, as needed*)
- Named Color preferences (*named colors are generated and assigned automatically*)
- Bill of Material Costs: removed dollar values, formwork, board-feet, connections (a simple material take-off remains)
- Rigid Diaphragms (*use [plates](#) to model diaphragms, more accurately*)
- Spreadsheet Report (*use: Save As .xls, then use Excel!*)
- Email Support (*did not work for many email clients*)

## Major New Features

### System

- 64-bit Architecture for large projects, advanced analysis
- Notification system for IES critical messages to customers
- DirectX Graphics (replaced older OpenGL system)
- [Shape](#) & [Material Databases](#) have changed format

### General / User Interface

- Ribbon Menu/Toolbar with smart sizing, great tooltips, easier to use
- Graphic View tabs moved to top, more windows are tabbed views
- Status panel for errors or other information about your project
- Hot-Keys (shortcuts) for most commands
- Added radian units for rotational stiffness terms
- Create tab has more options
- Quick color-themes for graphics
- Simplified preferences, with better limits and help
- Automated 'settings', like preferences, remember the last setting you used)

### Graphics / Filters

- Hover-highlighting in graphics
- Named Colors are assigned automatically (no setup required)
- Sticky-Notes may be placed on Graphic Views
- Smarter Selection with Object Keys (e.g., M for Member)
- Revit-like "Tab Selection" among objects hovered over
- Rotation about selected line objects
- Snap-points along edges or members for drawing

### Modeling

- Smarter, faster plate meshing
- Plate elements now offer moment-releases
- SJI Virtual Joist and Joist Girder tables for member properties
- Smarter naming system
- Combined members are managed automatically ('connect crossings')
- Area Sides are optional, add them to specific edges
- Import DXF Circles, Ellipses, Solids and Closed Polygons
- Clipboard Exchange is now "units" aware and more complete
- Check Model for Errors runs automatically in the background
- Model checking is more sophisticated
- Faster, more flexible ways to create nodes

### Loading

- Sortable lists in Load Case Manager



- Wind load project-wide settings are easier to access
- Preference for load direction arrow directions
- Scale all loads in a service case

## Analysis

- 100% background analysis (ready when you are)
- View partially-converged results during 2nd-order analysis
- Ability to perform a Buckling or Pushover analysis (via partial results)
- "Mode Shape Cases" for multiple-frequencies in Dynamic Response analysis
- Skip certain frequencies for Dynamic Mode Shapes
- Dynamic Response analysis produces a Base Shear result

## Results

- Displacement amplification option added
- Result validation is automatic on every analysis
- Faster post-processing
- Plate-mesh Moment & Shear diagrams (drag a line graphically)

## Design (w/Design Level)

- Improved accuracy for stresses and deflections
- Steel single-angle, double angle and tees are more accurately checked
- Improved support for custom and parametric cross-sections
- Many Concrete Slab design improvements (flexible rebar, optimize rebar, minimum checks...)
- More accurate/robust calculation of wood Load Duration factors
- Performance improvements (members checked in parallel with multiple processors)
- More control during Design Optimization (search)
- More control over Quick Design
- Choose a "Check Level" to balance performance with preliminary design/reporting
- Aluminum heat affected zones

## Reporting

- Use a Custom Logo in Header (same as ShapeBuilder or VisualFoundation)
- Concise result tables are available
- Report Templates (formerly called Styles) are better managed
- Click to Sort table columns
- Drag to Resize table columns
- Easier Add/Remove for tables and columns
- Better report viewer (preview, zoom, thumbnails, etc.)
- Export to clipboard, comma or tab-delimited
- Save to more file formats (.pdf, .xls, .docx, etc.)
- Reporting performance is dramatically improved

## Advanced Level\*\*

# VisualAnalysis 19 User's Guide

- P-Delta is available for Time History analysis
- Moving loads on "member chains" with reduced restrictions
- Moving loads: lane loads create results on all model objects (not just members)

## Bug Fixes (since version 12.0)

- Many, many fixes. Hundreds actually.

## 7.1.4 Prior Version 12.0

## Introduction

This upgrade is an incremental step forward to improve your productivity and eliminate minor trouble-spots prior to a major rewrite of VisualAnalysis that is expected in the next upgrade cycle.

## Added Features

- Concise **Member Force and Displacement report** tables (one line per member!)
- **Member Graphs**: cleaner look, easier to use, filter improvements
- Steel Design per **CSA S16 (2014)**
- **Wood Design** allows **parametric** rectangle and round shapes
- Report Wizard is smarter about load cases and result cases
- **Clipboard Exchange**: will now Modify or Delete nodal or member loads
- **SDNF 3.0** (Steel Detail Neutral File) import / export
- Cold-formed Steel updated to **CFS 8.0**
- **Import Custom .scl files** directly (right-click on shape database tree)
- **Custom Load Combination**: automatically "clones" a selected combination
- Nodal Settlement loads appear in the Find Tool window
- Manually editing a Design Group, removes it from the 'Auto-Group' feature
- Improved diagnostics in **Check Model for Errors**
- Added support for VisualFoundation 6.0 features

## Optional 64-Bit Version

Good for larger memory-intensive projects: Time History, AISC-Direct, or hundreds of Load Combinations might exceed the 2GB (theoretical) memory limit of the 32-bit version. The 64-bit version does have some **limitations**, so you may not want to use it for everyday projects.

- No STAAD import/export feature
- No SDNF import/export feature
- No Cold-Formed Steel design
- No performance improvement over 32-bit version
- You *may* install both versions on a 64-bit machine
- Not included in the IES Updater list, install updates manually
- Does not automatically open .VAP projects from Windows Explorer: right click to use **Open With**

## Fixes or Changes (since version 11.0)

- Parametric I-Beam, plastic modulus was incorrectly calculated for steel design (by 10-15%)
- Missing toolbar problem eliminated
- Project Manager remembers it's width on exit/restart
- Find Tool window remembers it's height on exit/restart
- Find Tool window uses more concise member result tables (one row per member)
- Overlapping member loads (linear and/or uniform) are detected in various places
- Result tables default to 'extreme rows only' (use **Tools | Preferences, Reports** to change default)
- Parametric Angle shapes were reporting Geometric rather than Principal stiffness
- Editing table column unit-precision was not working properly
- Double-click result report is no longer the "Complete Member" report
- Footnote added to "Member Extreme Results" table to explain load case numbers in ()'s
- STAAD (.std) Import, would not read Steel database shapes properly
- STAAD and SDNF commands have their own menu-items.
- Split Member might sometimes "mess" with Design Groups
- Time-History analysis now works properly with one-way members
- Fixed AISC shear check on double-angle shapes
- Fixed Aluminum combined stress ratio bug fix
- Wood design reports now show the full material name
- Aluminum design: more intermediate values are reported
- Clipboard Exchange: minor improvements to display in dialog box

## Removed "Features"

- Customize member graph option in Filter (confusing, settings would randomly change)
- Ability to persist custom member graph settings across VA sessions (didn't work well)
- Saved window layout (toolbars would go "missing" far too regularly)

## 7.1.5 Prior Version 11.0

## Introduction

Our primary focus with this upgrade is to keep you current with updated design specifications and building codes. Our secondary concern is to smooth out some rough edges and refine the product so that it works smoothly. While we have added a few new features designed to improve productivity, there is a major ongoing effort behind-the-scenes at IES to create the "next" big platform for VisualAnalysis.

## Major Added Features

- **IBC 2012** Load Combinations
- Steel Design per **AISC 360-10** (14th Ed.)
- Wood Design per **NDS 2012**
- Concrete Design per **ACI 318-11**
- Cold-formed steel design per **NAS 2012** (CFS 8.0)
- Rotate Views about a selected node or member
- Easier Node-Dragging/Member Extension in "Draw Nothing" mode
- Auto-Mesh by Area for more fine-grained control of plate meshing

## Other Added Features

- Improved Help File layout, search
- Area color added to preferences
- Updated Shape & Material Databases
- Design Results report lists all members in a group (and those unchecked)
- Generate Copies is 10,000 times faster
- Project Summary Report shows Building Code Load Combinations used
- Works with VisualFoundation 5.0
- Works with VAConnect 2.0
- Importing Load Cases through Clipboard Exchange is infinitely faster
- Member Graphs with Moving Loads are vastly improved
- Design material is displayed alongside Design parameters
- Concrete Beam design adds a deep-beam check
- Steel Single Angle design is more accurate

## Miscellaneous Fixes

- Toolbar-layout is no longer customizable (because restoring them failed too often)
- Rotating a model, Area span directions are now correct
- Wire-frame overlay no longer obscures results in a Result View (Picture View mode)
- Fixed memory-leak when switching among Result Cases (in Picture View mode)
- Semi-rigid end connections are now displayed graphically (with Filter option)
- Mirror-copy would fail to copy triangular plates properly
- Improved display of reaction labels near plate elements
- OpenGL graphics improvements in Model View
- Corrected issue with 'Shear Tab' design groups getting renamed after opening a project file

## 7.1.6 Prior Version 10.0

## Introduction

Welcome to VisualAnalysis 10.0. The engineers at IES have worked hard to implement many customer-suggestions for improving and extending the software. We attempt to do this without disrupting the normal work flow for long-time customers and without over complicating the product. Most new features are optional and fairly isolated items or are just natural extensions to help you work more quickly and easily.

## Major Added Features

### Ice + Wind Loading on Members (Design level)

**Benefit:** Allows you to design "open" (e.g. lattice tower, bridges) structures more easily.

**How:** Apply either of two new load types to member elements. VisualAnalysis automatically calculates ice weight given a thickness, and wind pressures on the surface area of member (or member + ice) as a function of height (per ASCE 7). New load sources  $D_i$ ,  $W_i$  are available for these types of loads and are included in load combinations.

## AASHTO Load Sources

**Benefit:** More straightforward application of AASHTO for load combinations and results.

**How:** There is a preference setting to select types of load sources to generate in your projects. Apply loads in newly named load cases, and create or import custom load combinations according to AASHTO requirements. (Load combinations for AASHTO are not really automated in this release.)

## Stress Checks (Generic) *(Advanced level)*

**Benefit:** Quick member stress-limit checks for any shapes or materials or for design codes and specifications not provided in VisualAnalysis. Allows you more code-flexibility.

**How:** There is a project setting to group members for stress checks in the **design criteria**. In the design view you may have or create design groups for member elements. You specify stress limits (tension/compression) and software checks all the results for you.

## Copy Multiple Loads from Member to Member

**Benefit:** Easier ways to generate your loads on members.

**How:** Select all the loads on a member, **copy & paste** to another member or group.

## Integrated Steel Connection Design *(Design level, through IES VAConnect)*

**Benefit:** Huge time saving feature and sophisticated calculation for column base plates (with ACI Appendix D anchorage calculations) and shear-tab connections for beams. VisualAnalysis assembles and exports all the connection data to VAConnect utilities (installed and purchased separately).

**How:** Possible connections are shown in the **Design View**, grouped automatically. You can manually adjust connection-grouping and then select a group to export your geometry and results to either the Base Plate or Shear Tab tool for design. A report is saved and available in VisualAnalysis for review and status indicators in the graphics help you keep track of which connections you have designed already.

## Import Loads into Multiple Load Cases

**Benefit:** More flexibility for very complex loading situations.

**How:** Use the **Home | Clipboard** to import loads into specific cases.

## Engineering Features

- Override K-factors for steel design when using AISC Direct Analysis method
- Top of Steel feature integrates better with manual member centerline offsets
- Wood Cc (curved glulam) override setting allows smarter design
- Deflection limit preferences save you time
- Rigid Link results are available in Result View (optionally)
- Beam Deflections report table (post-processed analysis displacements for beams)
- Tapered Member stress checks (via generic stress check)
- Design Group table reports controlling load combination (report and Find Tool)
- Metric rebar option is now a project-setting (Modify tab for Project Settings), there is also a preference setting.
- Cable elements show initial Sag in Modify tab

## Functionality and User-Interface Features

- Improved graphics
- Highlight Report viewing mode (selected items shown 'normally' others are 'ghosted')
- Editing in Project Manager is much improved (far fewer clicks required!)
- Undo/Redo for design groups is friendly for accidental changes

# VisualAnalysis 19 User's Guide

- New color preference settings gives you more control over graphics
- Member result colors are much cleaner in picture view mode
- Area Sides report (and Find Tool) table
- Member Graph customization is easier to access
- Warning to prevent very long reports (customizable limit)

## Advanced Level Features

- Autodesk Revit 2013 support (see the Supplementary downloads page at the web site)

## Minor Fixes

- Performance improvements and robustness for scissor nodes
- Member connection forces report truncation of data was fixed
- Rotation menu & toolbar tips are correct
- Wood CF fixes
- Bill of materials reporting of glulam board-feet improved
- Exit application is allowed when Report View is active
- Wood design deflections are improved (scaled with E)
- Improved unit-conversion factors for obscure units
- Math expressions in edit controls work properly with a leading negative value
- Fixed repeated error messages when importing from STAAD files
- Unity checks would report failure for 0.3% over 1.0, adjusted default limit.
- When unity checks are suppressed, there is a watermark in the Design View
- When unity checks are disabled for a group, the report and help-pane indicates this
- Clipboard exchange export list of load cases no longer shows empty cases.

## Features Removed

- The base-plate design report wizard was obsolete and has been replaced by IES VACONnect integration.

## 7.2 Upgrade Guide

### Version 19.0 Upgrade Guide

#### Top Features

- Composite beam design overhaul
  - Full or partial composite design
  - Permanent pre-composite deflections
  - Full control of pre-composite loads
- CSA concrete design specification added
- ACI 350 concrete design specification added
- Cold-formed steel design updated to CFS 12
- More powerful extreme filtering in tables
- Added a '2D Design' purchase level option

## Model

- Import CFS library now prompts before overwriting an existing file
- Shape selection box shows a weight to help with choices
- Drawing grid improvements
- Member offsets, new option to only offset the member graphically
- Improved named color mode with color preferences
- Insert a vertex between two selected vertices
- Improved graphics makes it easier to see member shapes
- Control the names of copied objects
- Meshing improvements at shared area boundaries
- Stiffness adjustment factors available for all members
- Stiffness adjustment factor available for plates (manual or auto)

## Load

- Report generated area loads
- Improved performance of generated area loads

## Analyze

- Result View inspector shows member results at any specified offset
- Result View inspector shows displaced distance between two selected nodes
- Member forces can now be reported in the geometric coordinate system
- Hotkeys added to Precision button sets it to maximum or minimum
- Improved time-history analysis and documentation
- Improved time-history Node Graph view

## Design

- Composite Steel Beams
  - Built in steel deck database
  - More accurate flexural capacity
  - Deflection checks correctly superimpose permanent pre-composite deflections
  - Full or Partial composite design
  - Shored or unshored construction
  - Full control of pre-composite loads
  - Ability to apply camber
  - Composite detailing checks added
- Concrete design per CSA A23.3
- Concrete slab design per ACI 350 for environmental structures
- Find/select ungrouped members using the find tool
- Cold-Formed Steel per CFS 12.0 using the latest AISI provisions
- Design Search dialog now offers size constraints
- Design Search now supports multiple categories of shape profiles
- Shortcut/Hotkey for toggling between select all in group or individual elements

# VisualAnalysis 19 User's Guide

- Number of legs can be specified for stirrups in concrete design
- Wood design offers increase for Le/d ratio per NDS 3.7.1.4
- Concrete column interaction capacities are more accurate

## Report

- Improved filtering of table extremes
- Bill of Materials table now includes total weight
- Improved report footers with cleaner table breaks across pages
- Member graph includes project file name

## Succeed! (Interface, Performance, Reliability)

- Support for Revit Structure 2020
- Export Welded Flange Plate connection to VAConnect 4.0+
- Documentation overhaul and update
- Easier to export to SketchUp (desktop or cloud)
- Improved performance of the preferences dialog for resetting graphics
- Improved responsiveness of the user interface
- Multiple instances of VisualAnalysis no longer generates the 'crash protection file found' message
- Less distracting task bar

## 7.3 Support Resources

### Did you Search this Help File?

Be sure you make use of the [help and support built into the software](#), as described in the [Essentials](#) section of the User's Guide. This document may be searched, and you should try different potential terms, sometimes less is more when searching--use just the unique word or words! There is also a logical Table of Contents available.

### Do Not Contact Support For:

- **Licensing** or **Sales**: use [www.iesweb.com](http://www.iesweb.com) or [sales@iesweb.com](mailto:sales@iesweb.com).
- Questions about **how to model** a particular structure. Such questions are your responsibility as an engineer.
- IES cannot **validate your model** or your results. If the "seem" incorrect, please figure out WHY they are incorrect. If you can document a defect, we will be happy to investigate deeper and fix things as necessary, but we cannot afford to check every customer's model.
- Questions about **engineering theory**. IES is not in the business of educating engineers. There are textbooks referenced in this help file and we can provide more guidance as to where to look if you cannot find one.

### Technical Support

- **Support Email**: [support@iesweb.com](mailto:support@iesweb.com) (Replies are usually **within 2 business hours**, if you don't hear anything within a day, assume it got spam filtered or lost and follow-up! For best results be sure to ask a question, indicate exactly which IES product & version you are using, include as much detail as is practical or relevant, including attaching a project file. *"I have a problem, can you help?"* is a frequently submitted question, to which the answer is always: *"Maybe, what is the problem!"*.)
- **Support Telephone?** **No, sorry!** We have found this to be too inefficient for everybody. With email you can



attach a screen shot, a project file, and we can better direct your question to the IES expert for that product or area. Phone 'tag' takes longer than you think.

- **Business Questions:** For any **licensing** or **sales**-related questions or issues: [sales@iesweb.com](mailto:sales@iesweb.com).
- **Free Training Videos:** See the Table of Contents in this help system!

## 7.4 Improving Performance

VisualAnalysis algorithms are fast by design. Your computer can execute billions of instructions per second. Most VisualAnalysis models you create will analyze in less than 2 minutes and produce reasonable reports. However, just like with any tool, you can get in over your head and become a slave to the machine, waiting literally **HOURS** for things to process. Please do not let this happen to you.

Most VisualAnalysis customer models contain far less than 10,000 nodes and 150 load combinations. If your model might approach either of these values, then you should really think about performance long before you start modeling.

### Background Processing

When you make changes to your project, VisualAnalysis will show you a progress indicator in the status bar, showing it is doing some work in the background. **You do not need to "wait" for this!** VisualAnalysis takes advantage of the fact that your computer is sitting idle 95% of the time. We use multiple-threading to get some work done. This will not slow you or your other programs because the threads are separate and given low priority. You may use Windows Task manager to monitor how your processor (and all of its cores) are used, and when, and by whom.

### Divide & Conquer

Build a model that answers only the questions you need to answer. You might need different models for different questions.

Think about what you want to learn from your model, then model only the essential components. If you can split your structure along a line of symmetry, or at an expansion joint, or otherwise, it might save many hours. Working with a few smaller models can be significantly faster than working with one gigantic model.

Processing time increases on the order of  $N^3$ , where  $N$  is the number of nodes in your model.

### KISS Modeling

You have likely heard the phrase: "Keep it simple, stupid." When modeling your structure think first, sketch later. Start with the fewest number of elements to accurately model the geometry and boundary conditions, especially with plate elements. Then refine from there, as needed.

### Graphics Hardware & Options

Picture View mode can be more expensive than drawing without it, especially in a Result View, where displaced shapes are drawn with stress colors.

Your video card hardware can have a significant impact on graphic performance. VisualAnalysis utilizes Microsoft's DirectX graphics system. If you experience poor performance, graphical "artifacts" such as stray lines, unusual blocks of color, fuzzy text, or similar usability issues, you should investigate or update the video card and drivers. There are a wide range of hardware manufacturers, but the cards are usually based on chip-sets from one of three major companies: NVIDIA, ATI-AMD, or Intel. We have found that most video cards for PCs work just fine. Laptops or tablets may have much lower-quality and/or performance.

We have seen very poor performance from **NVIDIA Quadro** series cards, which are common on 'workstation' type

machines.

Your mouse and mouse driver could also impact performance and behavior to some extent (middle-mouse button configuration and mouse-sensitivity settings, etc.). There is a known issue in Microsoft code that affects certain mouse drivers and maximized windows--if you see strange crashes that do not happen if your window is not maximized, you might try a different mouse.

## Advanced Analysis

The fastest analysis is a first order analysis with a linear model. P-Delta is more expensive. Direct Analysis adds load combinations and more iterations. Moving Loads and Time History analysis can be very time consuming.

## Prune Load Cases & Combinations

Analysis, design, and reporting are all directly impacted by the volume of results. The Live Load Reduction feature will add additional load combinations. The Direct Analysis Method adds "Notional Loads" and therefore more load combinations.

Before you add 10,000 loads in 35 load cases with 200 load combinations, check to see that your model is stable under self-weight **and then proceed**. If you are using automatic Building Code combinations, you might end up with many "redundant" load combinations, ones that you know will not control. The computer program cannot make this judgment and blindly assumes any one of them could control. It pays big dividends to get rid of extraneous combinations, not just in analysis and design time, but also in report size! You can perform this pruning in the **Load Case Manager**, on the **Combinations** tab.

## Design Performance

Design performance is directly related to the number of elements, the number of result points along members, and the number of load combinations that need checking. During 'preliminary design', you might use just a few custom load combinations rather than the full set of building code combinations. The performance vs. accuracy settings below can also speed up design checks. Design checks are performed in parallel, so using a CPU with more cores or thread capacity can improve performance.

You can skip unity checks by disabling design groups that you are not directly working on. You can change the [check-level](#) in a design group to get better performance during unity check operations as well.

## Performance vs. Accuracy Settings

With numerical solutions, answer are always approximate and oftentimes calculated at a number of discrete points. You can reduce the number of places where this happens, balancing between performance and accuracy. VisualAnalysis provides an easy place to manage these settings: Project Settings, Performance.

## Hardware: CPU & Video Card

Most desktop computers have faster CPUs, video cards, and other systems. Laptops can be very low-end. Upgrading your machine can potentially have a big impact on your performance. For a good look at hardware comparisons and available products visit: [www.cpubenchmark.net](http://www.cpubenchmark.net)

See also: [Analysis Performance](#)

## 7.5 My Model is Unstable

Some of the connection problems discussed above result in mechanisms (structures that have moving parts), but there are other ways to create mechanisms in a VisualAnalysis model. Some of these are obvious once you "see" the problem. Others

are more subtle mathematical instabilities that would not happen in a "real" structure, but cause problems in the matrix analysis.

## Plane Frames or Trusses?

You can change the structure type in Project Manager to a Plane Frame, Otherwise, to stabilize a planar model in a Space Frame structure type, **simply Shift+Click on a node and fix all of them in DZ** (or your out-of-plane direction).

## Correcting 3D Instability

When trying to analyze models in 3D it is common to get instability because of either (a) forgetting about the out-of-plane direction, (b) forgetting about rotations, or (c) having simply too many end-releases and/or not enough support. You can debug your model in this fashion:

1. Do you have sufficient support at the base of the model to prevent both translation and rotation?
2. Look for duplicate nodes (perhaps increase the default nodal tolerance first)
3. Look for overlapping or crossing elements that are not really connected.
4. Check that each member's **Connect Crossing** setting is set to **Yes** (default), except for X-braces.
5. **Remove ALL the member end releases** (shift+click a member), except perhaps simple beams.
6. Is your model stable for analysis under both dead and lateral load? reasonable displacements?
7. If so, **add end-releases carefully**, only add releases where you need them. (If you don't have weak axis bending, you don't need weak axis releases!)
8. Repeat step 5, as necessary to eliminate moments you do not want or expect.

## Animate the 'Failure' Mode Shape

VisualAnalysis can help you locate mechanisms in your model by performing a modal analysis. If a modal result is the only result available, it means your structure was unstable. You can animate the result view to get an idea of how or why the model is not stable.

## 7.6 Validate Your Results

### Before You Analyze

Before you perform an analysis, you should carefully check all input data. You should always use the **Tools | Model Check** command. You still may want to manually note that features like end releases and support conditions are correct. You may also want to take a look at the Picture View to visually observe member sizes, member materials, orientations, and locations to ensure they are correct.

In a Model View you may also want to check the local axes, beta angles, and other properties using the **Modify** tab (as an inspector) or the **Filter** tab options. Use the Find tool to sort objects based on any property shown in a column—mistakes tend to float to the bottom or top of the list!

Reports are available to record the data you have entered and provide another way to find mistakes. Refer to the Reporting section for more information about reports.

### Total Load Checks

One of the first checks that should be made after an analysis is to verify your total structural loading. Use the **Result** tab of Project Manager to see the Statics Check for each load case. The applied loads are totaled in each direction.

This information is also available in a statics check report. Included in this report will be the total load applied to the

# VisualAnalysis 19 User's Guide

structure in each global coordinate direction for each load case. Check these numbers against an estimate of the actual loads applied. Verify that the reported totals are in the ballpark with your estimates. If there is a discrepancy use the Model View to verify load directions and magnitudes.

## Static Checks

The Statics Checks are available under the Result tab of Project Manager or in a Report View will help you find many types of problems.

Check for nearly unstable structures. If you have poor geometry or very flexible members in critical areas, the structure can be on the verge of collapse due to instability. Many times unbalanced reactions can be a tip-off for these problems. This imbalance is automatically checked at the end of the analysis phase. You might receive a warning message if the Statics Check imbalance is significant.

## Displacement Checks

Look at the deformed shape of your model. Does it make sense based on the loading and structure? Remember that the displaced shape is usually exaggerated so you can see it. For true displacement display use a zero for the Displaced Shape Factor in the **Filter** tab for a Result View.

Look at the magnitude of the largest displacement shown using the **Result** tab in Project Manager. Is it large? If displacements are too large the basic assumption of small displacement is violated and results must be questioned.

## Reasonable Stress Checks

When you are comfortable with the loads, statics, and displacements you should also check stresses. Use the **Filter** tab for a Result View to show stress values and the legend. Look at the extreme value presented in the legend. Are the stresses reasonable? The software will blindly place 1,000,000 ksi on a wood member without warning! Would you? It only takes a second to zoom in on the extreme color and see where it exists. Make a decision as to whether or not it is reasonable.

## Validation is Up to You

Finally, use your experience and engineering judgment. If something just does not look right, investigate it carefully. Convince yourself that the results are correct before continuing.

Getting correct results is up to you as an engineer. We make every effort to test the software but it is impossible to prove it correct under all circumstances. If you have a problem please investigate it carefully. Compare the results with another program, hand calculations, or estimates. Before you contact us please prove to yourself that there really is a problem in the software—we do not provide consulting support, or "model checks" for you.

If you find an error giving you incorrect results we want to know about it! Carefully document the problem and then contact us using the support channels outlined in the Troubleshooting chapter or on our web site. IES is committed to maintaining a high quality tool in VisualAnalysis. We stand behind the software and will work quickly to solve any problems you might expose.

## 7.7 Educational Version

Since 1994, IES has offered a free educational version of VisualAnalysis. This is available for students and faculty members at institutions in the USA and Canada that offer engineering degrees. Students and faculty should visit [www.iesweb.com/edu](http://www.iesweb.com/edu) for updates and educational support information. Please review the educational limitations below as some commercial features are not available.

## User's Guide

For detailed information on VisualAnalysis, refer to the [User's Guide](#).

## Upgrade Guide

To review changes from the previous version and see what's new, read the [Upgrade Guide](#).

## Limitations

The educational product is intended for **Educational Use Only**; it should not be used for profit or consulting work. The educational product is the advanced level of VisualAnalysis, with the following limitations:

### Project Size Limits

- Up to 5500 nodes
- Up to 1000 members
- Up to 5000 plate elements
- Maximum of 40 factored load combinations, if you 'generate' too many, convert them to manual, and delete some!

### Restrictions

- No Auto-meshed areas (you may use manual plate meshes)
- No Design checks, except for steel (limited)
- No Design 'search' or optimization to resize members

## 8 Integration

### 8.1 How To

#### 8.1.1 Example: Create CFS Library and Import into VisualAnalysis

Using CFS from RSG Software ([www.rsgsoftware.com](http://www.rsgsoftware.com)), you can create custom cold-formed shape libraries that can be incorporated into IES databases. The step-by-step process below outlines creating a CFS shape library file (.cfsl) using the CFS program and importing the file into the IES Shape Database for use in VisualAnalysis and other IES products.

#### Folder Structure

In order to create a CFS library file (.cfsl), the CFS section files (.cfss) must be organized into a specific directory structure. The figure below shows how the shape files should be organized within this structure.

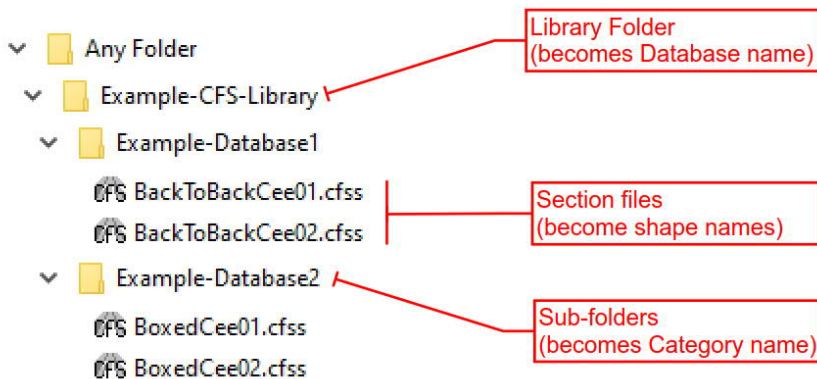

All the section files must be in one of the Section Type sub-folders of the Library Folder. The name you use for the library folder will become the name of the generated library file. The names you use for each of the section type folders will become the section type names stored within the section library. You may have any number of section files in each sub-folder and any number of types in the library. You must have at least one section in one sub-folder within the library folder.

The library file will be located in the same directory as the library folder and will have the .cfsl file extension.

#### Step 1: Create CFS Section Files

Create one or more section files (.cfss) using CFS. Save the .cfss files using the Folder Structure hierarchy as described above.

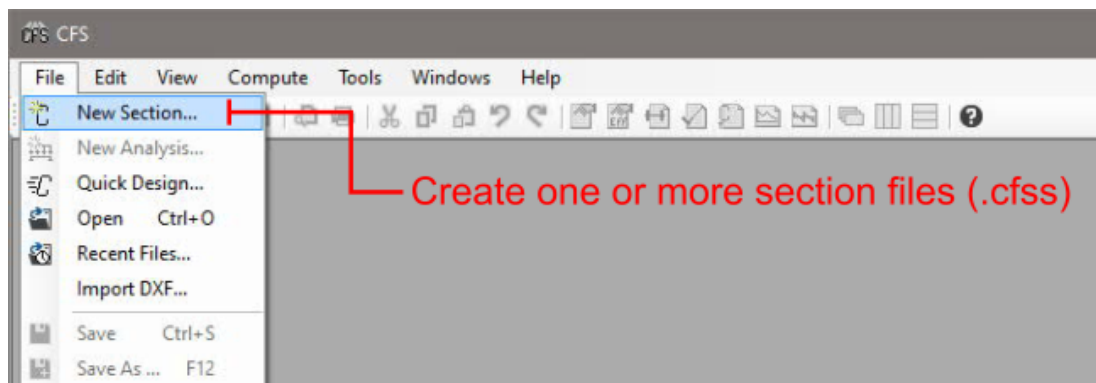

## Step 2: Build the CFS Library

To build the .cfs library, select **Tools | Library Builder...** from the CFS menu. Browse to the directory that contains the library folder (e.g. "...\Any Folder\Example-CFS-Library"). Complete the Company and Address fields with whatever information you feel is pertinent to the library. Select the Build button to create the library.

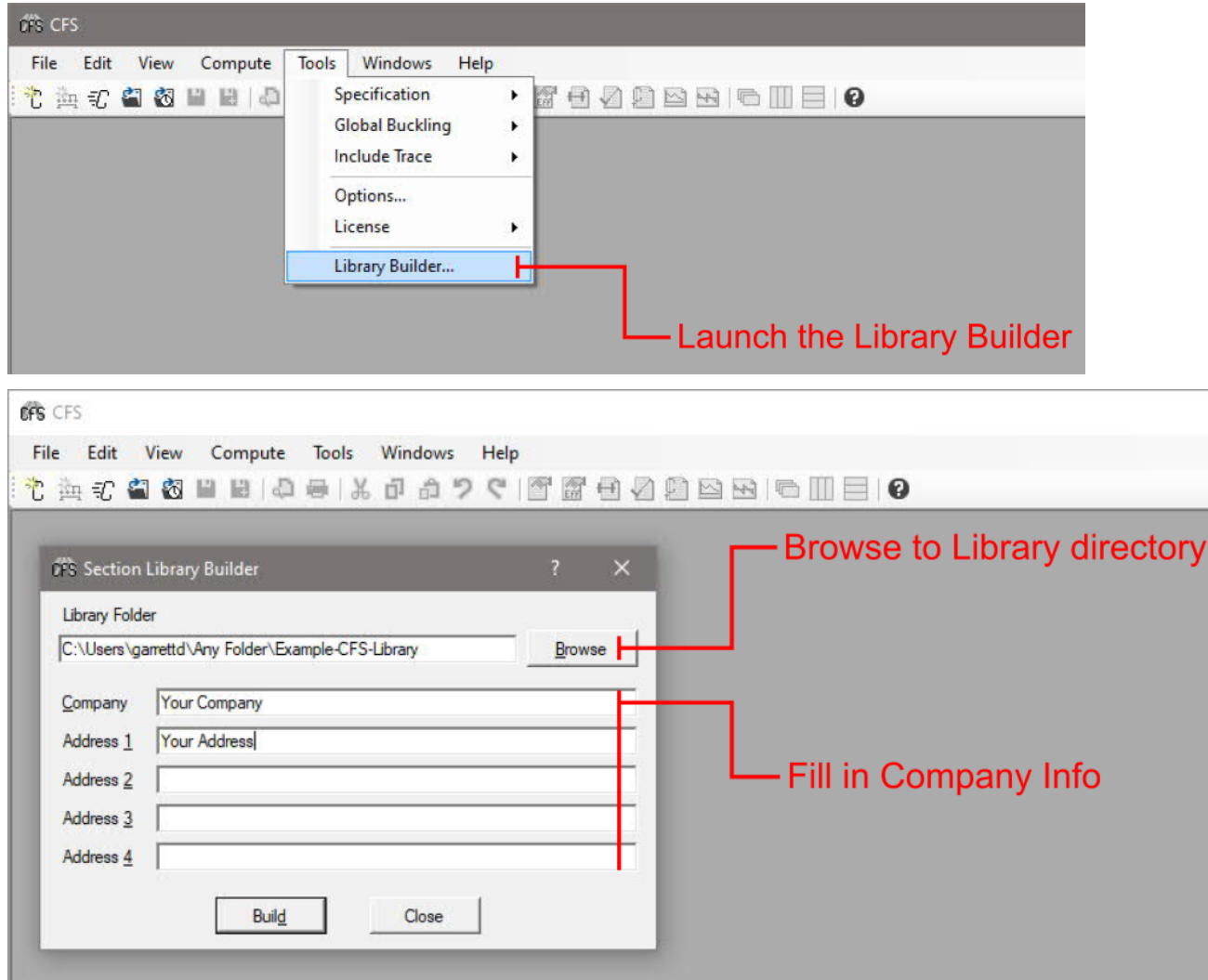

## Step 3: Import the CFS Library to the IES Shape Database

In VisualAnalysis, select **File | Import | Import Cold Formed Library**. Browse to the .cfs file created in Step 2 and select Open to import the file to the IES Shape Database. VisualAnalysis will need to be restarted after the library has been imported.

# VisualAnalysis 19 User's Guide

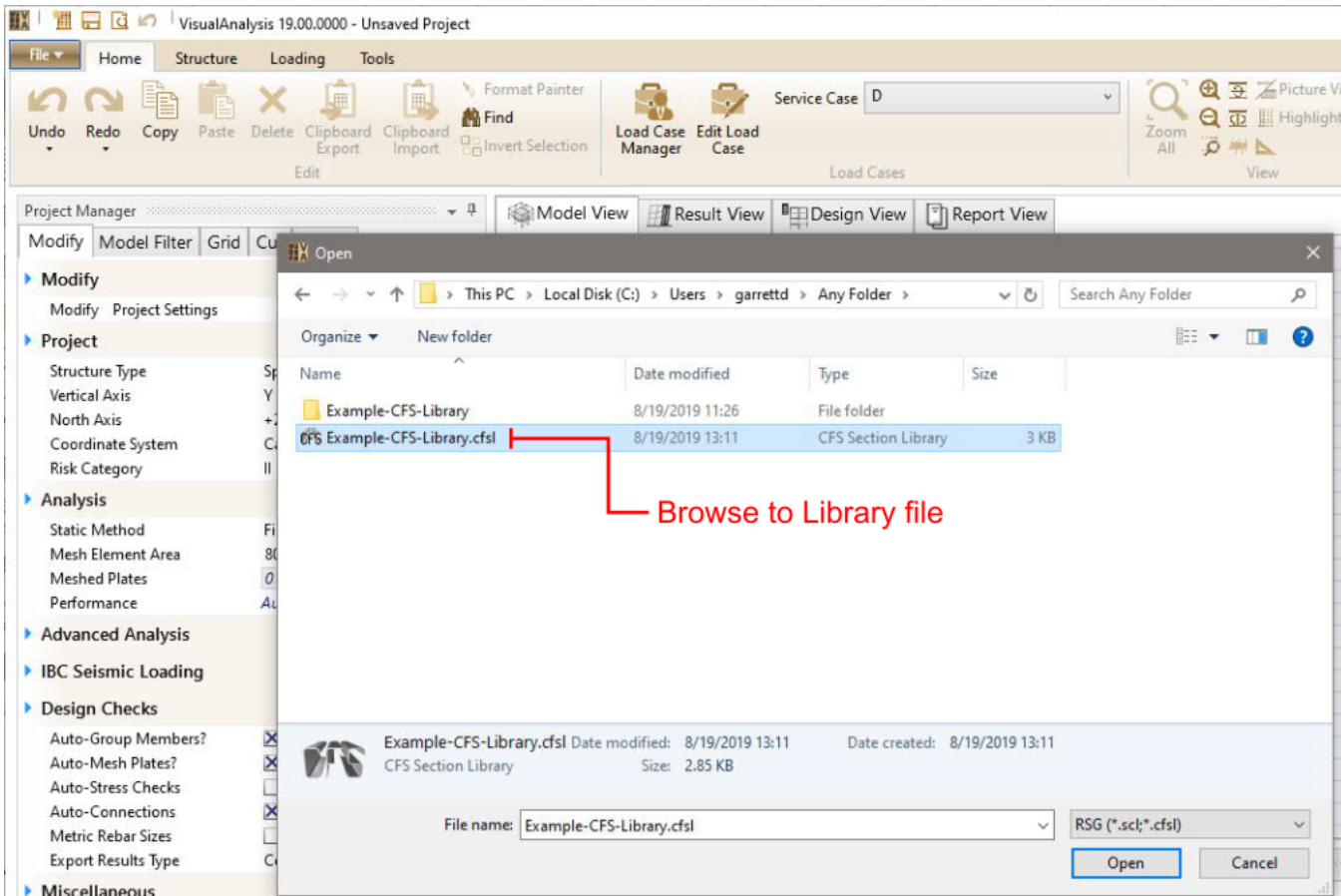
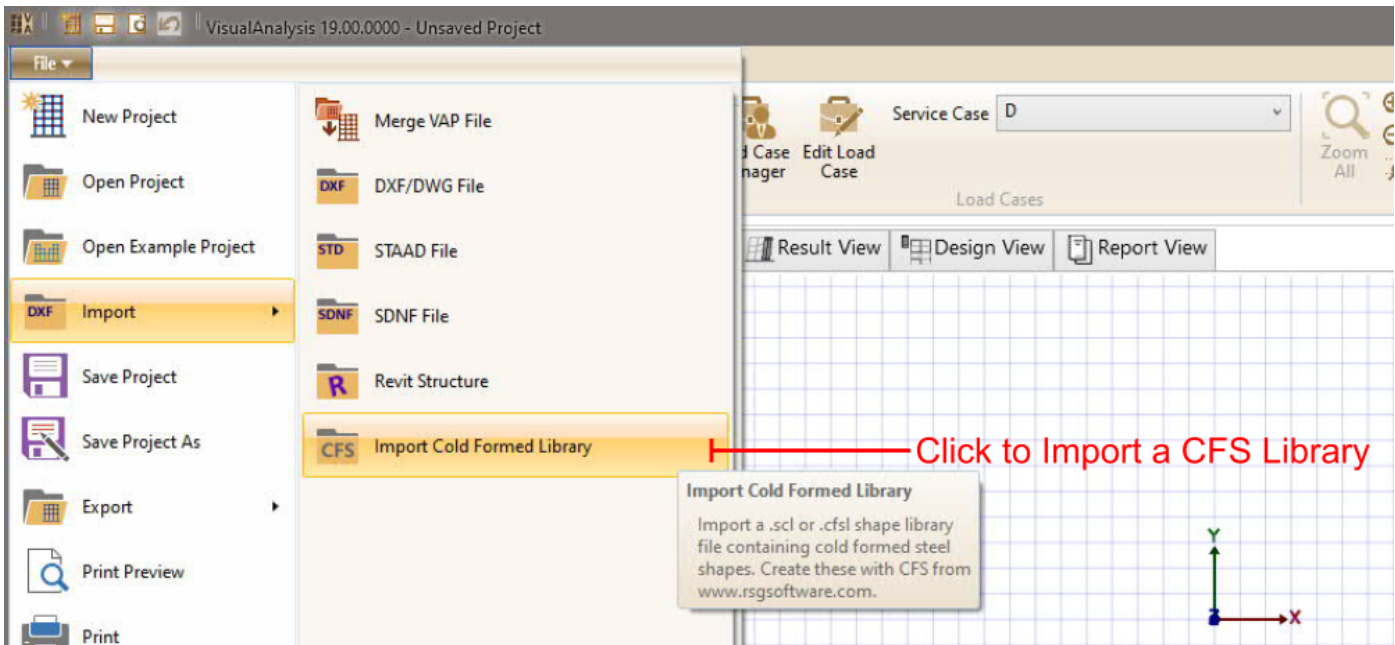

## Step 4: Use the imported shapes in your VisualAnalysis model

All shapes that were imported in Step 3 are now available to be used in VisualAnalysis. The shape libraries are located in the Shape Database under the Custom category.



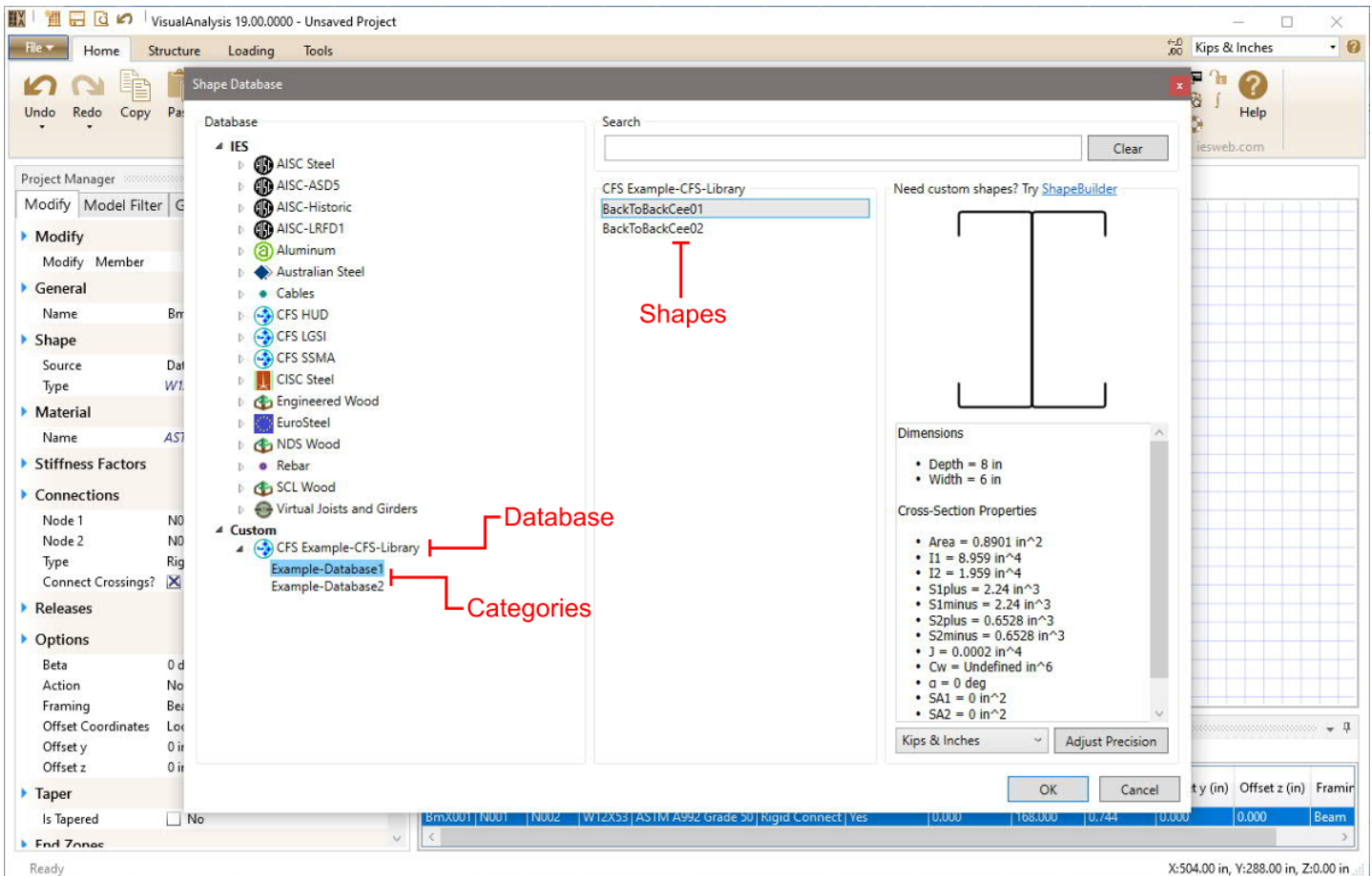

## 8.2 IES ShapeBuilder

### Section Properties Calculator

Create custom shapes to obtain section properties for analysis or design checks, analyze for stress distribution, transformed composite properties, and more.

### Custom Shapes

Certain custom shapes created in ShapeBuilder can be exported to the [Shape Database](#) used by VisualAnalysis. You can then build models with member elements using the custom shape. Common steel, wood, and aluminum shape-profiles are generally supported for design-checks in VisualAnalysis. See ShapeBuilder's Help for details.

### Purchase ShapeBuilder

To buy licenses for ShapeBuilder, please visit the web site or call us.

## 8.3 IES VisualFoundation

### Requires: IES VisualFoundation

There are two independent ways that VisualAnalysis and VisualFoundation can work together to help you solve problems

# VisualAnalysis 19 User's Guide

(the tools are not completely integrated or interactive). Note: [VisualFoundation](#) and VisualAnalysis are sold separately by IES. The [Foundation Design Video](#) shows how the programs work with each other.

1. Export from VisualAnalysis to VisualFoundation (using the [Export to VisualFoundation](#) feature).
2. Create a VisualAnalysis project file from VisualFoundation (using the [File | Export to VisualAnalysis](#) feature).

## Foundation Design (Export from VisualAnalysis to VisualFoundation)

The [Export to VisualFoundation](#) feature exports the geometry and reactions from VisualAnalysis to set up a mat footing in VisualFoundation. This allows you to quickly generate a footing geometry for one or more columns from the VisualAnalysis project. The column locations are automatically imported and the reaction forces from VisualAnalysis service load cases are brought into VisualFoundation as loads. VisualFoundation provides foundation-specific design checks.

### Foundation Design Procedure

1. Select one or more supported nodes in the VisualAnalysis project.
2. Choose [Structure | Create Foundation](#) to create a foundation for export.
3. Run an analysis, analyzing all the Service Load Case to obtain reaction forces at nodes.
4. With the foundation selected, use the [Tools | Export to VisualFoundation](#) feature to launch VisualFoundation and create a new footing project.
5. The VisualFoundation project can then be modified and design checks can then be performed. Save the project to create a .vfp file that can be opened for future use.
6. Upon exiting VisualFoundation, the foundation in VisualAnalysis is updated with a new boundary and thickness.
7. You can report a "Foundation Table" which lists all the footings by name, and provides thicknesses, areas, and which columns are supported. This table can be used to help coordinate with any saved VisualFoundation project files.

### Foundation Design Limitations

- Support nodes must lie in a global plane (parallel to X, Y, or Z)
- Only member elements are exported as columns to VisualFoundation (walls or columns modeled out of plate elements do not export).
- The orientation of the model in VisualAnalysis is flexible (Y is the vertical axis by default). When the vertical axis is not Z, then model coordinates are mapped according to the following right hand rule transforms, and load cases are renamed accordingly.
  - Vertical Axis = X: Y-->X, Z-->Y, X-->Z
  - Vertical Axis = Y: X-->X, X-->Y, Y-->Z
- Multi-part footing or multi-thickness footings cannot be created directly from within VisualAnalysis
- The foundation cannot be edited or updated from VisualAnalysis (if you try to Design the foundation again it will simply create a new project in VisualFoundation).
- A VisualFoundation project cannot be opened and used to update a VisualAnalysis project (even if it was created from VisualAnalysis).
- If a multi-part footing is created in VisualFoundation, only the outside boundary is shown in VisualAnalysis.
- The details of the foundation are not shown or reported in VisualAnalysis (only the graphics and the thickness are shown and reported).
- VisualAnalysis is updated from VisualFoundation only when VisualFoundation is closed and only if it was launched from within VisualAnalysis.

## VisualAnalysis Files (.VAP) Created by VisualFoundation

VisualFoundation can be used to create a VisualAnalysis project file (.vap) using the [File | Export to VisualAnalysis](#)

feature. The .vap file can be used to look at the finite element model that was created behind the scenes in VisualFoundation or to perform more advanced analyses (such as a dynamic analysis) which are not supported in VisualFoundation. VisualAnalysis also provides more advanced capabilities for designing grade beams and foundation elements.

## 8.4 IES VA-Revit Link

### Requires: Advanced Level

The **IES VA-Revit Link** free utility provides BIM (Building Information Modeling) features, through the ability to merge or create .vap (VisualAnalysis) files from **Autodesk**  [Revit Structure](#). The link is bi-directional: the merge or create process can happen in either VisualAnalysis (.vap) or Revit (.rvt) files. VAREvitLink runs as an **add-in** within Revit Structure, you do not need to have VisualAnalysis installed on the machine where you use this tool. [Download](#) this page from the IES web site.

## 8.5 IES VAConnect

### Requires: IES VAConnect

### Requires: Advanced Level

VAConnect consists of two stand-alone utilities for connection design, currently just steel connections per AISC. These programs can be launched from within VisualAnalysis. Integration with *VAConnect* can save a tremendous amount of time because it exports forces from many load cases and multiple joints, saving you all the bookkeeping. In VAConnect, there is a steel base plate component with anchorage calculations, and a beam-to-column shear-tab component.

### How to Use IES VAConnect

1. Turn on the Auto-Connections option in the Project settings. You may customize these.
2. Define **Result Type** in project settings: VAConnect can use service case results or "pre-factored" results.
3. Go to Load Case Manager and turn on the analysis for all necessary load cases (they may not be enabled for service cases).
4. Use the Filter the **Design View** you show connection icons, click on the connection to view properties and access VAConnect.

## Connection Shapes & Geometry Limitations

### General Requirements

- Steel materials and shapes only
- **Grouped** connections must be 'identical' in type, shape, orientations, etc.
- Only **LRFD** load combinations are supported

### Base Plate Requirements

- Base plate is assumed to be perpendicular to the member's local axis
- A **single** member framing into a supported node or with spring-supports (**no braces** may frame into this node!)
- Permitted shapes: I-Beams, HSS (rectangular tubes), Pipe, Rectangle, or Round
- Will **not** design plates for **biaxial** bending.

## Shear Tab Requirements

- Beam is nearly perpendicular to column or girder with end-released connection (~15° tolerance)
- A single member framing into a support column or girder
- Permitted beam shapes: I-Beams, Channels
- Permitted supporting member shapes: I-Beams, Channels, HSS, Pipe, Rectangle or Round

## Notes:

- The preferred approach is to export service-case results. While you may export "factored" results into *VACconnect*, which would go in as "prefactored" loads. This is not the best way to design a connection. Use the **Export Results** type in **Project Settings**.
- The coordinate systems are different between VisualAnalysis and VACconnect.
- Member local forces in VisualAnalysis are exported to VACconnect, transformed into the appropriate directions.
- Once the project is created in *VACconnect* it is not "updated" from *VisualAnalysis*, and no information transfers back to *VisualAnalysis*.
- If your forces change in *VisualAnalysis* you must start the process over or manually update the *VACconnect* project.
- VACconnect reports are only available in VisualAnalysis 'per session'. If you exit and restart VisualAnalysis any VACconnect reports are no longer present.
- No connection data input into VACconnect is currently stored or transferred back to VisualAnalysis.
- You may save VACconnect project files manually to store your input-data and settings for each connection design.

## Troubleshooting

If you have problems launching VACconnect from within VisualAnalysis, check the following:

1. Uninstall any older versions of VACconnect (2.0 or 1.0) and VisualAnalysis (prior to 12.0), from Control Panel
2. Check the "File Associations" on one of the example Base Plate and/or Shear Tab projects that ship with VACconnect
3. Re-install the latest versions of VisualAnalysis and then VACconnect

## 8.6 IES QuickFooting

### Requires: IES QuickFooting

QuickFooting designs and checks a spread-footing under a column. The tool provides sophisticated checks of the footing and pedestal including all the rebar details. Integration can save a tremendous amount of data-entry time by exporting reactions from many load cases and multiple columns automatically.

### How to Use IES QuickFooting

1. Define **Export Result Type** in the **Project Settings**: QuickFooting can use service case results or "pre-factored" strength-level load combination results.
2. If exporting Service Cases, go to **Load Case Manager** and enable analysis for all the service cases.
3. After analysis completes, **select** one or more supported **nodes** in the Result View and choose **Tools | Export to QuickFooting**.
4. Design your footings and save your project through QuickFooting.

## Notes

**No information transfers back to VisualAnalysis.** If your forces change in VisualAnalysis you must start the process over or manually update the *QuickFooting* project. Your QuickFooting project is completely independent of your VisualAnalysis project.

When exporting **strength-level results**, for prefactored loading in QuickFooting, you get lower-quality design checks. Also, you may get extra load combinations from VisualAnalysis that do not need checking in QuickFooting.

**Sign conventions** and coordinate systems may be different in QuickFooting than in VisualAnalysis.

## Purchase QuickFooting

To learn more about [IES QuickFooting](#) or to purchase licenses, please visit the web site or call the sales office.

## Troubleshooting

Common solutions for export issues:

1. Uninstall **older versions** of QuickFooting from your machine, using the Windows Control Panel.
2. Check the "**File Associations**" on a QuickFooting (.ftg) project file to make sure that Window Explorer will open it with the latest version of QuickFooting.

## 8.7 CFS

### Unity Checks in VisualAnalysis

Cold-Formed steel design checks are performed within VisualAnalysis by a component licensed from RSG Software. You do not need to purchase CFS to access this feature, you simply need the Full Design level of VisualAnalysis. See [Cold-Formed Design](#) for more information about this feature.

### Creating Custom Shapes

The stand-alone CFS product may be purchased from RSG Software ( [www.rsgsoftware.com](http://www.rsgsoftware.com)) and used independently from VisualAnalysis. Using CFS you can create custom cold-formed shape libraries that can be incorporated into IES databases.

Use **File | Import | Cold Formed Library** to add a custom .scl or .cfsl data files, or you may simply place your data file into the [Shapes](#) folder for IES Customer data.

## 8.8 Windows Clipboard

### Capabilities

The clipboard exchange is designed as a way to create, modify, or merge models and loads in ways that may not be possible inside VisualAnalysis. It also allows data from other kinds of software. You can use the mathematical capabilities of a spreadsheet to manipulate your nodal coordinates for defining very complex, curving geometry.

- **Supported Model Objects:** nodes, members, plates, and spring supports.
- **Supported Loads Types:** nodal loads, uniform and linearly varying member loads, uniform and linearly varying plate loads.
- Model objects may be Added or Modified (by Name)
- Loads may be added, modified or removed (set magnitude to zero)
- Factored Load Combinations may be added

# VisualAnalysis 19 User's Guide

- Can export all items or only selected items. Also can export only certain types of items.
- Can be used to merge project geometry and connectivity information from one VisualAnalysis project into another.

## Units

The current unit style is used for import or export, but you can override this by including a Units table at the top of your file with a unit style name. You may also include units along with any data value in any table. When exporting you can optionally include the unit name on every data value.

## Limitations

- No support for areas, area loads, rigid links, or cable elements.
- Many modeling features, such as member taper, end zone, or centerline offsets are not supported.
- No support for thermal loads, nodal settlements, or other 'specialty' loads.
- Member wind & ice loads are exported simply as 'uniform' loads, so importing them back in will change their definitions.
- Imported loads must be attached to imported nodes, members, or plates, or items that already exist in your model.

## Export

You choose what to export, based on type of object and selection status. You can export with units next to values which will export with the current unit-style. If you choose to not export units, then we always export using our **internal units** of "Kips, Inches, Radians, Seconds".

## Import

You are given the option to review the data found on the clipboard and confirm it is what you expected. No model objects have been added to your VisualAnalysis project at this point and you can end the operation by pressing **Cancel**. Objects existing in your model (by name) are **modified**, otherwise new objects are generated. You may **delete loads** on import by setting their magnitude to zero.

## Import Data Format?

 **Discover the Import Format:** create a simple model that contains the kinds of objects you want to import, and export it. Then use that text as your template.

## 8.9 DXF/DWG Files

VisualAnalysis has the ability to import and export .dxf and .dwg CAD files. This drawing format typically contains basic geometry and connectivity information only, not an entire structural model. VisualAnalysis can do only so much with this format! DXF transfers will not support many of the features or properties of your models, but can help you save time in setting up complex models or in getting drawings started after creating a model in VisualAnalysis.

## Disclaimer

Because the DWG and **DXF™** formats are controlled by **Autodesk® Inc.**, and not IES, Inc., it is not possible to read all DXF

files, or to output files to specific format requirements, and these formats may change after our tools have been tested! CAD systems often use Z as the vertical direction, where VisualAnalysis prefers Y (though it functions with any axis vertical--set it in Project Settings), so you may wish to swap coordinates when importing or exporting.

**CAD files are "dumb" collections of drawing entities**--they do not contain a structural model! VisualAnalysis cannot always guess the intention of these lines or other entities and may require your assistance. Before importing your DXF file, check to make sure that the lines connect nicely (don't overlap), that coordinates are reasonable and near the global origin. For best results, split arcs and circles in to lines or poly-lines where they will cross members or nodes in your final model. You may need to import more than once, experimenting with settings or adjusting the CAD drawing slightly before it imports properly. Even then you may need to work with the project after importing to make a good model out of the data.

## [Import a File](#)

Use [File | Import | DXF File](#) to read a drawing into the current project. You can also use [File | Open](#) and select DXF files to start a new project from a DXF file. This is a good way to create a model with complex geometry or to save work when a drawing is available before you begin. There are a number of options when importing from DXF files.

**Layers:** DXF files may contain lots of non-structural noise, be sure to include only the layers you want to import.

**Select items to Import:** This allows you to selectively import entities from the file while ignoring others. You can also define basic default properties to items (like member shapes and materials) before importing.

**Swap Y and Z coordinates:** VisualAnalysis uses Y as the vertical axis by default, while most CAD programs use Z. You can perform this translation automatically. The default is to swap the coordinates.

**Units:** Select the units that were used in the DXF file.

**Scale Factor:** You can scale the dimensions of the DXF model up or down by a constant factor. Every nodal coordinate position in the DXF file will be multiplied by the scale factor before it is displayed in VisualAnalysis.

### **Entities Imported:**

- POINTS become nodes
- LINES, POLYLINES, CIRCLES, or ARCS become members
- SOLID or 3DFACE become a plate element

## [Export a File](#)

To save a model as a CAD drawing use [File | Export to DXF](#). There are a number of options in the Export to DXF dialog box.

**Swap Y and Z coordinates:** VisualAnalysis uses Y as the vertical axis by default, while most CAD programs use Z. You can perform this translation automatically. The default is to swap the coordinates.

**Units in DXF:** Select the units to display information in the DXF file. For the maximum precision, you may want to use a "small" unit like inches or millimeters.

**Scale factor:** You can scale the dimensions of the model up or down by a constant factor. Every nodal coordinate position in VisualAnalysis will be multiplied by the scale factor before it is written to the DXF file.

**Selected items only:** Selecting this option (on by default) lets you limit the items exported only to those items that are currently selected.

## 8.10 STAAD Files

 This feature is **deprecated** and may be removed. It is time to transition to the Windows [Clipboard Exchange](#), or other ways of generating or importing models.

## What is This Feature?

You may import or open STAAD (.std) script files as an entirely new project, also known as command language files. To open a STAAD file you may use [File | Import | STAAD File](#). You may also export to a **pseudo** STAAD file, which will require editing before importing into VisualAnalysis or any other program.

## Why STAAD?

The purpose of this feature is to **make possible** some data transfer of basic model and load information among different structural analysis products. It may not be easy.

STAAD has been around a very long time and many programs offer STAAD import/export abilities. This command is not designed to read most .std files without some simplification! It does not begin to support every feature of this command language. You will need to modify your .std file in order for VisualAnalysis to read it successfully.

## Limitations

Many STAAD commands are not supported either for import or export. Some commands are 'accessories' to the core model and load data and will just be ignored. Other commands will impede your ability to import the data at all. The STAAD file is text-based, you can edit it in Notepad to remove commands before importing!

We do not even expect to be able to read back a STAAD file that we write out! You may need to edit or modify any STAAD file before it will import into VisualAnalysis.

## Supported Commands

The following commands are acceptable, but may be **significantly restricted** in terms of options or features! You may still need to edit or remove some of them.

**STAAD** (SPACE)

**UNIT**

**JOINT COORDINATES**

**MEMBER INCIDENCES**

**ELEMENT INCIDENCES**

**MEMBER TRUSS**

**MEMBER RELEASE**

**MEMBER PROPERTY** (Prismatic and database shapes should work, **names must match exactly** the VA shape path and name)

**ELEMENT PROPERTY (THICKNESS)**

**DEFINE MATERIAL**

**ISOTROPIC**

**SUPPORTS**

**LOADING**

**SELFWEIGHT**

**JOINT LOAD**

**MEMBER LOAD (UNI, CON, TRAP)**

**ELEMENT LOAD PRESSURE** (Local only)

**LOAD COMBINATION**

**FINISH**

## Unsupported Commands



These common **unsupported commands** may prevent your STAAD file from importing:

**CONSTANT** [use DEFINE MATERIAL and ISOTROPIC instead]

**PERFORM ANALYSIS**

**REPEAT**

**CODE**

**GENERATE**

**PAGE**

**OUTPUT**

## 8.11 Command Line

### Batch Processing

VisualAnalysis supports a command-line analysis through an input file in the format used by the Clipboard Exchange feature. The program will then perform an automatic static analysis and create an output report file. This type of analysis is useful for integrating VisualAnalysis with other software tools or systems or for managing a complex, changing model or other iteration processes.

### Command Line

#### Example Command Line:

```
VisualAnalysis.exe "C:\data\myproject.txt" "C:\myresults.txt"
```

#### Command Line Specification:

```
[Path]VisualAnalysis.exe "input file" "output file" ["Report Style Name"]
```

**Input File:** Specifies the complete path to a text file in the format of [Clipboard Exchange](#). If the path contains space characters, it will need to be quoted.

**Output File:** Specifies the complete path to an output file, which may be .txt, .pdf, or .xlsx format. If the path contains space characters, it will need to be quoted.

[Optional] **Report Style:** Specifies a [report style](#) name, if omitted a default report will be generated. You must manually create or modify report styles using the interactive features of VisualAnalysis. Note that report styles are [saved per-machine](#).

### Operation

1. After parsing the input file, a static, linear analysis will be attempted automatically.
2. If there is an error in parsing, it will be written into the output file.
3. If there is an error in analysis, it will be written into the output file.
4. The program will exit with a return code.

#### Return Values:

0 = Success, presumably.

-1 = Failure, the error message will be included in the output report.

-2 = Failed to parse the command line.